



TRANSITIONAL  
SHELTER  
GUIDELINES



# TRANSITIONAL SHELTER GUIDELINES

This consensus publication:

- ▶ offers a definition and explains the 10 principles of transitional shelter
- ▶ indicates when a transitional shelter approach may be inappropriate
- ▶ shows how to design and implement a transitional shelter programme with communities



definition

1

- definition of TS
- 10 TS principles
- 5 characteristics
- when not to use TS
- SWOT

tool

2

- decision-making tool

programme

3

- coordination
- programme plan
- assessment
- beneficiaries
- labour
- materials
- procurement
- support
- quality assurance

site

4

- community
- site selection
- site planning
- land tenure
- handover

design

5

- socio-cultural
- minimise risk
- climatic design
- materials
- construction

resources

# TRANSITIONAL SHELTER PROCESS

- Upgradable
- Reusable
- Relocatable
- Resaleable
- Recyclable

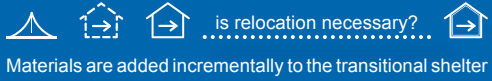

PRE-DISASTER OPTIONS

LAND TENURE

RECONSTRUCTION

POST-DISASTER OPTIONS

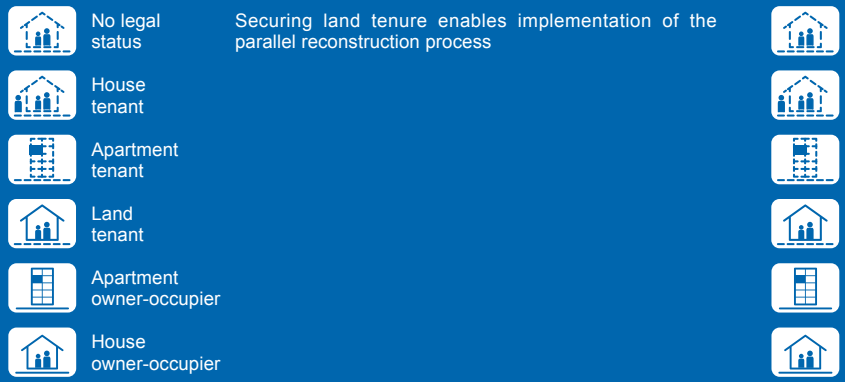

# TRANSITIONAL SHELTER GUIDELINES

**This consensus publication:**

- ▶ offers a definition and explains the 10 principles of transitional shelter
- ▶ indicates when a transitional shelter approach may be inappropriate
- ▶ shows how to design and implement a transitional shelter programme with communities

Published by:  
**Shelter Centre**

Email: [info@sheltercentre.org](mailto:info@sheltercentre.org)  
Website: [www.sheltercentre.org](http://www.sheltercentre.org)

Part draft May 2009  
Final draft November 2011  
First edition: May 2012

A catalogue record for this publication is available for download from the Shelter Centre library, [www.sheltercentre.org/library](http://www.sheltercentre.org/library)

The findings, interpretations and conclusions expressed herein do not necessarily reflect the views of the International Organization for Migration or its Member States.

The designations employed and the presentation of material throughout the work do not imply the expression of any opinion whatsoever on the part of IOM concerning the legal status of any country, territory, city or area, or of its authorities, or concerning its frontiers or boundaries.

Material in this publication may be freely quoted or reprinted, but acknowledgement is requested, together with a reference to the document number. A copy of the publication containing the quotation or reprint should be sent to Brian Kelly ([bkelly@iom.int](mailto:bkelly@iom.int)), Nuno Nunes ([nnunes@iom.int](mailto:nnunes@iom.int)) and Shelter Centre ([tsg@sheltercentre.org](mailto:tsg@sheltercentre.org)).

**International Organization for Migration (IOM)**

17, Route des Morillons  
CH-1211 Geneva 19  
Switzerland

Tel: +41.22.717 9111  
Fax: +41.22.798 6150  
Email: [hq@iom.int](mailto:hq@iom.int)

## Funding

Support and funding from the United Kingdom's Department for International Development (DFID) was received for the initial drafting of these guidelines.

Subsequent funding and support from the International Organization for Migration (IOM) has made the finalisation of this project possible, including support from the Swedish International Development Cooperation Agency (Sida).

## Acknowledgements

This project has been made possible thanks to DFID, Sida and IOM.

Brian Kelly, Head of IOM Pakistan's Emergency and Stabilization Unit, acted as project manager and coordinating editor on behalf of IOM. Nuno Nunes, CCCM Global Cluster Coordinator, supported the project from IOM Headquarters.

Shelter Centre is extremely grateful to Bill Flinn for his reviews and valuable contributions to this publication.

The executive editor of these guidelines is Shelter Centre Executive Director Tom Corsellis.

### Lead authors and production team comprised

*Jo Ashbridge*

*Antonia Bengono-Muanze*

*Britt Christiaens*

*Sarah Cook*

*Dave Curtis*

*Andrew Cusack*

*Maria Evangeliou*

*Stephen Fitzmaurice*

*Simon Golds*

*Stéphanie Gomez de la Torre*

*Pilvi Halttunen*

*Laura Heykoop*

*Lisa Irvine*

*Federica Lisa*

*Cristina Mazzone*

*Jennifer Milne*

*Christoph Müller*

*Ana Margarida M. Ramos*

*Joanna Read*

*Pedro Salavessa Garcia*

*Estelle Soh*

*Valérie Veroustraete*

### Additional contributions were made by

*Rob Fielding*

*Laura Martinelli*

*Sevket Öztas*

*Julia Phillips*

*Joseph Charles Woodward*

### External contributions were made by

*Hugh Earp, independent*

*Fiona Kelling, independent*

*Jim Kennedy, independent*

*Alison Killing, independent*

Shelter Centre would especially like to thank Fiona Kelling for her advice and contributions to sections 3.2.3 Programme and project management and section 4.4 regarding land tenure issues.

Additional special thanks to Jim Kennedy for his specific contribution to section 4.5 regarding the handover of transitional shelter programmes.

## Photographs/images

### Cover photograph

*Rumana Kabir*

### Internal content photographs

*Dyfed Aubrey*

*Marco Botelli*

*Cordaid*

*Tom Corsellis*

*Oliver Dorighel*

*Leonard Doyle*

*Usman Ghani*

*Heiner Gloor*

*Habitat for Humanity*

*Asim Hafeez*

*Handicap International*

*IOM*

*IOM Haiti*

*IOM Pakistan*

*Adam Kalopsidiotis*

*Chris Kaput*

*Arie Kieviet*

*Chris Lom*

*Peter Manfield*

*Mike Meaney*

*Practical Action Latin America*

*David Sacca*

## Peer review

The publication was drafted and reviewed over the period May 2009–November 2011 at the Shelter Meetings, a biannual forum organised by Shelter Centre which is attended by the key NGO, IO, UN and government stakeholders in the global sector.

Shelter Centre would like to thank all organisations and individuals who have expressed their willingness to contribute to the process and peer review of the part draft in May 2009 and final draft in November 2011.

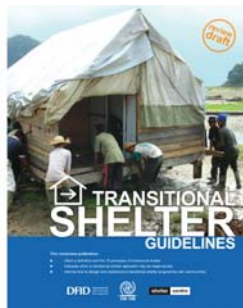
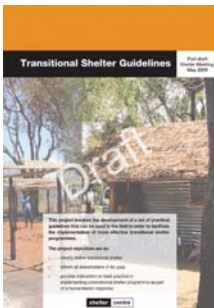

## Peer reviewers

John Adlam, DFID	Jim Kennedy, independent
Masood Akhtar, IOM	Esteban Leon, UN-HABITAT
David Alford, WASH Cluster	Manoucher Lolachi, UNHCR
Eddie Argenal, CHF	Francesca Lubrano, IOM Haiti
Joseph Ashmore, independent	Mike Meaney, Habitat for Humanity
Dyfed Aubrey, GOAL	Henk Mejrink, Cordaid/Caritas
Rick Bauer, Oxfam GB	Jérôme Michon, MSF-Belgium
Neil Brighton, Care/IFRC	Maria Moita, IOM
Adriana Carvalho-Friedheim, UN/OCHA	Isabelle de Muysen-Boucher, UN/OCHA
Giovanni Casani, IOM	Susith Premasisri, IOM
Igor Chantefort, IOM Haiti	Jeroen Quanyer, IFRC/Benelux Red Cross
Richard Choularton, CHF	Raghu Srinivasa Rao, NRC
Alex Coissac, IOM	Peter Roberts, independent
Simon Devine, Education for All	Shaun Scales, IOM
Hugh Earp, independent	Anna-Maria Selleri, IFRC
William Flinn, independent	David Stone, The ProAct Network
Mario Flores, Habitat for Humanity	Corinne Treherne, IFRC
Rainer Frauenfeld, UNOPS	Mark Wooding, Medair
Rod Imer, World Vision International	Jake Zarins, NRC
Adam Kalapsidiotis, independent	

The following Shelter Meeting peer presentations have been held as part of the revision process:

- 1<sup>st</sup> peer presentation, hosted by Swiss Solidarity, Geneva 7–8 May 2009.
- 2<sup>nd</sup> peer presentation, hosted by UNHCR, Geneva 12–13 November 2009.
- 3<sup>rd</sup> peer presentation, hosted by IOM, Geneva 27–28 May 2010.
- 4<sup>th</sup> peer presentation, hosted by UN/OCHA, Geneva 2–3 December 2010.
- 5<sup>th</sup> peer presentation, hosted by UNDP, Geneva 12–13 May 2011.
- 6<sup>th</sup> peer presentation, hosted by IOM, Geneva 1–2 November 2011.

Shelter Meeting participating organisations included:

### Inter-Agency Standing Committee (IASC) clusters

Camp Coordination and Camp Management; Early Recovery; Education; Emergency Shelter; Protection; Water, Sanitation and Hygiene.

### Humanitarian bilateral and multilateral donors

Danish People's Aid (DPA); DFID; Swiss Agency for Development and Cooperation Humanitarian Aid Unit (SDC/HA); Swiss Solidarity; The World Bank; United States Agency for International Development (USAID).

### United Nations bodies

United Nations Children's Fund (UNICEF); United Nations Development Programme (UNDP); United Nations Environment Programme (UNEP); United Nations High Commissioner for Refugees (UNHCR); United Nations Human Settlements Programme (UN-HABITAT); United Nations Institute for Training and Research (UNITAR); United Nations Office for the Coordination of Humanitarian Affairs (UN/OCHA); United Nations Office for Project Services (UNOPS).

### **International organisations**

International Organization for Migration (IOM); IOM Haiti; IOM Pakistan.

### **Red Cross and Red Crescent Movement**

International Committee of the Red Cross (ICRC); International Federation of Red Cross and Red Crescent Societies (IFRC); Red Cross National Societies (Luxembourg, the Netherlands, Switzerland, USA).

### **Non-governmental organisations**

Action Aid; Adventist Development and Relief Agency (ADRA); Architecture & Development (A&D); Architecture Sans Frontières (ASF); Bioforce Development Institute; CARE International; Caritas Switzerland; Common Humanitarian Fund (CHF); Engineers Without Borders UK (EWB-UK); GOAL; Groupe URD; Habitat for Humanity; Handicap International (HI); Islamic Relief (IR) Worldwide; Medair; Médecins Sans Frontières (MSF) Belgium; Norwegian Refugee Council (NRC); Oxfam GB; Oxfam India; ProAct Network; RedR; Relief International; Practical Action; Shelter Centre; Skat Foundation; World Vision International (WVI).

### **Academic institutions**

Eindhoven University of Technology (TU/e); London South Bank University; Oxford Brookes University; University of Glasgow.

### **National governmental organisations**

DFID; Royal Institution of Chartered Surveyors (RICS) Disaster Management Commission; Swedish Civil Contingencies Agency (MSB); Sida.





# FOREWORD

**Sustainable reconstruction often takes a number of years**, especially in urban environments. It is always a challenge to support shelter for affected populations over this period of time.

The shelters provided to persons in the aftermath of a disaster must meet good quality standards in order to last for a number of years, offering persons affected a safe, secure, healthy and dignified accommodation. They must also be of the right size and layout to enable beneficiaries to regain their livelihoods and to take the lead within efforts for reconstruction.

The transitional shelter approach articulated within this publication advocates for investment in construction materials into communities, thus supporting community-led reconstruction efforts and ownership within the recovery process.

This type of approach has sheltered millions of people in emergency responses all over the world, and has been adopted by various agencies, including the International Organization for Migration (IOM).

Since the introduction of the approach in 2005, no detailed guidelines have ever been published to fully capture the transitional shelter experience and to support humanitarian actors in the provision of transitional shelters.

The development of these guidelines reflects an extensive consensus-building process, involving 44 agencies as well as independent humanitarian specialists. Within the process, a number of detailed suggestions have been integrated from field practitioners managing transitional shelter projects and programmes from all over the world.

IOM is pleased to have contributed to this jointly developed tool for field practitioners, and believes this effort will have a positive impact on the improved shelter conditions of persons affected by crisis situations.



Mohammed Abdiker  
Director of Operations and Emergencies  
International Organization for Migration



**Programme managers and field staff need guidelines**

in order to understand if, when and how transitional shelter should be used. This publication provides a decision-making tool to aid this process. These are practically and succinctly explained in the 10 transitional shelter principles.

The transitional shelter approach engages a series of sectors involved in a response, including camps, recovery and water, sanitation and hygiene. When supported appropriately, this approach can also make a significant contribution to protection and environmental management.

Consultation with field practitioners often raises the common misconception that transitional shelter is a distinct phase in a response, coming between emergency shelter and reconstruction. In fact, transitional shelter is an incremental process, which begins with the first distribution of materials after an emergency. These guidelines aim to prevent these misunderstandings.

In consolidating lessons learned, the guidelines support the addition of transitional shelter to the range of other shelter and settlement options available to the humanitarian community in responding to conflicts and disasters.

**DFID** Department for  
International  
Development



John Adlam  
Director CHASE Operations Team  
Department for International Development



# TABLE OF CONTENTS

Acknowledgements	iii
Foreword	viii
List of diagrams, tables and photographs	xii

---

## INTRODUCTION

Background	xvi
Aim of this publication	xviii
Audience	xix
What is not in these guidelines	xxi
Explanation of graphics	xxi

---

## CHAPTER 1 Introduction to the transitional shelter process

1.1	What is transitional shelter?	2
1.2	10 principles of transitional shelter	10
1.3	The 5 characteristics of transitional shelter	15
1.4	When is transitional shelter not appropriate?	17
1.5	Transitional shelter SWOT analysis	18

---

## CHAPTER 2 Decision-making tool

Decision-making tool	21
----------------------	----

---

## CHAPTER 3 Programme design and implementation

3.1	Transitional shelter as part of a coordinated response	31
3.2	Developing a transitional shelter programme plan	44
3.3	Programme assessment	56
3.4	Beneficiary identification	64
3.5	Labour methods	70
3.6	Materials methods and sourcing	76
3.7	Procurement and logistics	82
3.8	Support methods	90
3.9	Quality assurance	96



---

<b>CHAPTER 4</b>	<b>Community site selection and planning</b>	
4.1	Supporting a community	111
4.2	Site selection	114
4.3	Site planning and communal infrastructure	123
4.4	Land tenure	129
4.5	Handover	135

---

<b>CHAPTER 5</b>	<b>Community shelter design</b>	
5.1	Designing with the community	138
5.2	Designing to minimise risk	147
5.3	Climatic design	159
5.4	Building materials	168
5.5	Construction principles	180

---

## **RESOURCES**

<i>Glossary</i>	195
<i>Acronyms</i>	200
<i>Annotated bibliography</i>	202
<i>References</i>	204
<i>Index</i>	210



# List of diagrams

## Chapter 1

- 1.1 Transitional shelter as an incremental process
- 1.2 Transitional shelter in the response cycle
- 1.3 Transitional shelter and cost

## Chapter 3

- 3.1 11 Global Clusters and lead agencies
- 3.2 Coordination framework
- 3.3 Communication methods
- 3.4 The four stages of assessment after a disaster
- 3.5 Balancing beneficiary numbers to level of assistance
- 3.6 18 assistance methods
- 3.7 The procurement process
- 3.8 Post-disaster supply demands
- 3.9 Planning an efficient distribution chain

## Chapter 4

- 4.1 Landslide-prone areas site considerations
- 4.2 Earthquake-prone areas site considerations
- 4.3 Hurricane/cyclone-prone areas site considerations

## Chapter 5

- 5.1 Elevated plinth
- 5.2 Improving foundation waterproofing
- 5.3 Earthquake resilient building plan layouts
- 5.4 Anchoring to foundations to prevent uplift
- 5.5 Roof shape and orientation
- 5.6 Rodent-proofing measures
- 5.7 Fire safety distance
- 5.8 Ventilating wall cavities
- 5.9 Ventilation principles for warm-humid climates
- 5.10 Shading opportunities
- 5.11 Ventilation strategy for hot-dry climates
- 5.12 Cold climate building principles
- 5.13 Plastic sheeting connection details
- 5.14 Fixing CGI sheeting
- 5.15 CGI sheeting details
- 5.16 Cut timber connection types
- 5.17 Bamboo connection considerations
- 5.18 Types of damage due to improper foundations
- 5.19 Main types of foundation diagrams
- 5.20 Anchor foundations
- 5.21 Pad foundation
- 5.22 Ground beam foundation
- 5.23 Suspended timber floor on a brick plinth
- 5.24 Solid floors

- 5.25 Framed wall
- 5.26 Function of bracing in framed walls
- 5.27 Rules of thumb for placement and dimensions of openings
- 5.28 Single pitched roof construction
- 5.29 Trussed rafter roof construction

## List of tables

### Chapter 1

- 1.1 The six settlement options for displaced populations
- 1.2 The six reconstruction options for non-displaced populations

### Chapter 3

- 3.1 Five cross-cutting issues and associated lead agencies
- 3.2 Coordination mechanisms and considerations
- 3.3 Strategy template
- 3.4 Logical framework approach template
- 3.5 Gantt chart example
- 3.6 DAC criteria for monitoring and evaluation
- 3.7 Key considerations for transitional shelter

### Chapter 5

- 5.1 Concrete mix ratios
- 5.2 Mortar mix ratios

## List of photographs

### Chapter 1

- 1.1 Principle 1—Assess situation, Pakistan, *IOM Pakistan*
- 1.2 Principle 2—Involve community, Pakistan, *Usman Ghani/IOM Pakistan*
- 1.3 Principle 3—Develop strategy, Pakistan, *IOM*
- 1.4 Principle 4—Reduce vulnerability, Haiti, *Cordaid Haiti*
- 1.5 Principle 5—Agree standards, Haiti, *Cordaid Haiti*
- 1.6 Principle 6—Maximise choice, Haiti, *David Sacca/Handicap International*
- 1.7 Principle 7—Buy time, Pakistan, *IOM*
- 1.8 Principle 8—Incremental process, Pakistan, *IOM Pakistan*
- 1.9 Principle 9—Plan site, Pakistan, *Leonard Doyle/IOM*
- 1.10 Principle 10—Reconstruction, Haiti, *Cordaid Haiti*
- 1.11 Upgradable 1—Pakistan, *IOM Pakistan*
- 1.12 Upgradable 2—Pakistan, *Usman Ghani/IOM Pakistan*
- 1.13 Upgradable 3—Haiti, *Mike Meaney/Habitat for Humanity*
- 1.14 Reusable 1—Pakistan, *IOM Pakistan*
- 1.15 Reusable 2—Haiti, *Adam Kalopsidiotis/IOM Pakistan*
- 1.16 Reusable 3—Pakistan, *IOM Pakistan*

- 1.17 Relocatable 1—Pakistan, *IOM Pakistan*
- 1.18 Relocatable 2—Haiti, *Cordaid Haiti*
- 1.19 Relocatable 3—Philippines, *IOM*
- 1.20 Resaleable 1—Haiti, *David Sacca/Handicap International*
- 1.21 Resaleable 2—Pakistan, *IOM Pakistan*
- 1.22 Resaleable 3—Pakistan, *Marco Botelli/IOM Pakistan*
- 1.23 Recyclable 1—Pakistan, *Usman Ghani/IOM Pakistan*
- 1.24 Recyclable 2—Pakistan, *IOM*
- 1.25 Recyclable 3—Haiti, *Cordaid Haiti*

### Chapter 3

- 3.1 Communication with the affected population, Pakistan, *IOM Pakistan*
- 3.2 *Chimen Lakay* newspaper, Haiti, *IOM Haiti*
- 3.3 Information kiosk, Haiti, *IOM Haiti*
- 3.4 Building damage, Pakistan, *Marco Botelli/IOM Pakistan*
- 3.5 Beneficiary selection assessment interview, Haiti, *Cordaid Haiti*
- 3.6 Direct labour, Haiti, *David Sacca/Handicap International*
- 3.7 Community labour, Pakistan, *Marco Botelli/IOM Pakistan*
- 3.8 Self-help labour, Pakistan, *IOM Pakistan*
- 3.9 General items emergency packs, Pakistan, *IOM Pakistan*
- 3.10 Locally sourced prefabricated timber frame panels, Haiti, *Cordaid Haiti*
- 3.11 Transitional shelter stockpiles, Leogane/Haiti, *Cordaid Haiti*
- 3.12 Distribution by boat, Sindh / Pakistan, *Chris Lom/IOM Pakistan*
- 3.13 Shade provision at distribution site, Pakistan, *IOM Pakistan*
- 3.14 Distribution site considerations, Pakistan, *IOM Pakistan*

### Chapter 4

- 4.1 Safe building workshop, Pakistan, *Usman Ghani/IOM Pakistan*
- 4.2 Access to clean water, Pakistan, *IOM Pakistan*
- 4.3 Site prone to vector-borne diseases, Pakistan, *IOM Pakistan*
- 4.4 Sensitive site, Pakistan, *Usman Ghani/IOM Pakistan*

### Chapter 5

- 5.1 Community meeting, Pakistan, *IOM Pakistan*
- 5.2 Participation of women in the decision-making process, Pakistan, *IOM Pakistan*
- 5.3 Culturally appropriate material choice, Pakistan, *Usman Ghani/IOM Pakistan*
- 5.4 Transitional shelter materials prototype, Haiti, *Cordaid Haiti*
- 5.5 Transitional shelter with ramped access, Haiti, *Sylvia Sommella/Handicap International*
- 5.6 Plastering to protect external walls from flood risk, Pakistan, *IOM Pakistan*
- 5.7 Ventilation techniques, Haiti, *Cordaid Haiti*



- 5.8 Upgradable shelter solution for a warm-humid climate, Leogane/Haiti, *Mike Meaney/Habitat for Humanity*
- 5.9 Quincha mejorada, Peru, *Practical Action Latin America*
- 5.10 Roof fixing, Haiti, *David Sacca/Handicap International*
- 5.11 Timber frame construction, Leogane/Haiti, *Cordaid Haiti*
- 5.12 Traditional 'clissade' technique of intertwined slats, Haiti, *David Sacca/Handicap International*
- 5.13 Bamboo roof structure, Pakistan, *Usman Ghani/IOM Pakistan*
- 5.14 Handmade air dried bricks, Pakistan, *Usman Ghani/IOM Pakistan*
- 5.15 Woven roof mats, Pakistan, *IOM Pakistan*
- 5.16 Sandbag wall construction, Pakistan, *IOM Pakistan*
- 5.17 Double pitched roof construction, Haiti, *Cordaid Haiti*

## Resources

- R.1 Transitional shelter, Lompré/Haiti, *Cordaid Haiti*



# INTRODUCTION

## BACKGROUND

- Transitional shelter as one response option**

1. The transitional shelter approach adds to other successful response approaches, such as core housing and semi-permanent housing, to broaden the range of options for governments and humanitarian stakeholders to support populations affected by disasters and conflicts.
- Recent use of transitional shelter**

2. The transitional shelter approach has been adopted by numerous humanitarian agencies, including the International Organization for Migration and has sheltered many millions of people worldwide who have faced challenges in achieving reconstruction and recovery after disasters and conflicts.
- Introduction of the approach**

3. The approach was introduced by staff from Shelter Centre, seconded by the Department for International Development to United Nations High Commissioner for Refugees following the Indian Ocean tsunami of December 2004. 📖 ALNAP, 2010. *Case Study No.5: Transitional Shelter*.
- Challenges in achieving adequate shelter over the reconstruction period**

4. Governments supported by the international humanitarian and development communities rarely have sufficient resources to support the repair and reconstruction of all damaged homes. Securing land tenure and completing reconstruction often takes many years for homeowners. For tenants, who are often the majority in urban situations, finding somewhere to resettle can also take a long time.
- Shelter response for the displaced**

5. Over this period, families need to find shelter, while reconstruction proceeds in parallel. Some may find shelter for a period with host families, in camps, in collective centres, or self-settle in existing buildings. These transitional settlement options may not be suitable for all families for the duration of reconstruction. 📖 UN/OCHA, 2010. *Shelter After Disaster (SAD)*. 📖 University of Cambridge, 2005. *Transitional Settlement Displaced Populations (TSDP)*.
- Shelter response for the non-displaced**

6. Reconstruction can also take many years for those not displaced, or for those who have returned from displacement. Shelter is needed when buildings are damaged beyond habitability. Families living in apartments as tenants and occupants with no legal status often face the greatest

challenges to transitional reconstruction. 📖 UN, 2010. *SAD*. 2010. 📖 The World Bank, 2010. *Safer Homes, Stronger Communities*.

Shelter response before transitional shelter

7. The usual response by governments and the international humanitarian community has been the distribution of tents or kits of basic shelter materials and tools, such as plastic sheeting and hammers. This response has many advantages including speed and, for appropriate kits, flexibility in being useful also for repair and reconstruction. This response is not intended to offer shelter over the long term. The usual lifespan of tents is between a few months and two years and good quality plastic sheeting is designed to last around 18 months.

Shelter impacts during reconstruction

8. The lack of adequate shelter over the entire reconstruction period impacts negatively upon health and livelihoods, thus constraining reconstruction and recovery. Regardless of the level of support offered by government and humanitarian stakeholders, it is the affected population that invariably undertakes the greatest effort, for example through self-help programmes 📖 UN, 2010. *SAD*. 📖 The World Bank, 2010. *Safer Homes, Stronger Communities*. This becomes a major concern when support is insufficient to cover needs, when the affected population must achieve reconstruction at least in part through their own recovery.

Transitional shelter process

9. Transitional shelter is an incremental process that shelters families after a conflict or disaster. It is not another phase of response as it begins with the first assistance offered, such as the distribution of plastic sheeting. Recovered materials and further support, such as through cash or further material distribution, enable incremental building and upgrading.

Transitional shelter materials

10. The transitional shelters built in this way are designed with the community in order to optimise protection from further hazards, health, livelihoods and give maximum flexibility in recovery. Standards, especially those relating to safety, that the shelters must reach are usually agreed between the government and humanitarian stakeholders. Transitional shelters use mainly local materials, thereby contributing to local and regional economies. The materials and construction methods are chosen to be familiar to those affected, requiring skills and tools that they have access to. The designs and materials are also chosen so that after reconstruction is complete, the transitional shelters can be upgraded, reused for other functions, sold or recycled into permanent housing.

Land rights and relocation

11. Any form of durable shelter normally requires land tenure and obtaining building permission from local authorities. Central to the transitional approach is that the shelters are designed as an exception to this, because they can be relocated, like

1

definition of TS  
10 TS principles  
5 characteristics  
when not to use TS  
SWOT

definition

2

decision-making tool

tool

3

coordination  
programme plan  
assessment  
beneficiaries  
labour  
materials  
procurement  
support  
quality assurance

programme

4

community  
site selection  
site planning  
land tenure  
handover

site

5

socio-cultural  
minimise risk  
climatic design  
materials  
construction

design

resources

caravans or trailers. As the shelters are begun when land rights are usually unclear, it is essential that it is possible to move the shelters to permanent sites, should this be required. Usually, tripartite contracts for each transitional shelter are drawn up between the affected household, the local government and the agency supporting implementation. These contracts set out the conditions under which the occupants may occupy the land, prior to formally resolving the rights to it.

Transitional shelter cannot be completely prefabricated

12. Imported, prefabricated shelters are not appropriate because they do not respond to local contexts. Their fabrication, importation and construction takes so long as to constitute another phase of response and delays reconstruction; their overall cost is often comparable to that of reconstruction. Tents would normally be used when there are insufficient local alternatives and when stockpiles can be airlifted. For these circumstances new transitional tents are under development. This development aims to prevent wastage of financial and physical resources through, for example, using a frame that can be upgraded with local materials.

Inappropriate transitional shelter

13. Transitional shelter has at times been used inappropriately. This is due to its continual refinement whilst in operation because of the constant evolution of the process. Further complications include the lack of a single common understanding of the aims and implementation of the approach, as well as the lack of any guidance on when and how to use transitional shelter and when to avoid it.

## AIM OF THIS PUBLICATION

14. This publication is intended to:

- ▶ offer a definition and explains the 10 principles of transitional shelter;
- ▶ indicate when a transitional shelter approach may be inappropriate; and
- ▶ provide guidance on how to design and implement a transitional shelter programme.

15. It is intended to support the process of transitional shelter as part of a single coordinated strategy, plan or policy for shelter and reconstruction for a response. However, it is not a technical construction manual.

16. The guidelines support collaboration between stakeholders in the process of transitional shelter by determining whether or not the process might offer a useful contribution to the single strategy and, if so, by defining the role each stakeholder should take in contributing to designing and implementing a transitional shelter programme.

17. To establish a successful transitional shelter process, a series of interests, priorities and capacities have to be understood, integrated and coordinated. The following pages give information on what these guidelines offer to specific stakeholders in transitional shelter programmes.

## AUDIENCE

This publication aims to support the stakeholders listed in the following text.



18. The affected population needs to understand the process of transitional shelter in order to participate fully in the design and implementation process. This stakeholder group may include:

- ▶ community leaders, representatives and committees;
- ▶ vulnerable and marginalised groups within each community;
- ▶ those within a community who are responsible for are users of communal infrastructure, such as roads and schools;
- ▶ those individuals within each household who undertake the main activities, such as cooking and childcare;
- ▶ the groups who traditionally undertake aspects of construction within each community; and
- ▶ construction industry professionals and trades, such as engineers and carpenters.



19. National and local governments need to understand the process of transitional shelter in order that they may support the process through their policies for the initial response and later recovery. Relevant stakeholders may include:

- ▶ the central government, with its task force or its department, ministry or agency responsible for coordinating the response;
- ▶ other government departments ministries and agencies, concerned with planning and surveying, housing and environmental issues; and
- ▶ local governments, including those responsible for communal infrastructure, land registration and housing.



20. Donors and funders need to understand key factors of the transitional shelter process in order to decide if funding for submitted transitional shelter proposals can be granted. These guidelines help to determine if a specific transitional shelter programme is appropriate.

1

definition of TS  
10 TS principles  
5 characteristics  
when not to use TS  
SWOT

definition

2

decision-making tool

tool

3

coordination  
programme plan  
assessment  
beneficiaries  
labour  
materials  
procurement  
support  
quality assurance

programme

4

community  
site selection  
site planning  
land tenure  
handover

site

5

socio-cultural  
minimise risk  
climatic design  
materials  
construction

design

resources



21. Coordination bodies need to understand the process of transitional shelter in order that they may support the process in its contribution within their single coordinated strategy. Relevant stakeholders are:

- ▶ the coordination body mandated for the response, i.e. government co-chairing with the Inter-Agency Standing Committee Humanitarian Country Team;
- ▶ the coordination body mandated for the sector, i.e. the response-level team of the IASC Emergency Shelter Cluster; and
- ▶ the coordination bodies mandated for other sectors and cross-cutting specialists, including water, sanitation and hygiene (WASH), recovery, protection, gender and environment.



22. Humanitarian agency staff need to understand the process of transitional shelter in order that they may support the process in its contribution to their single coordinated strategy. This stakeholder group may include:

- ▶ country-level managers and fundraisers;
- ▶ programme extension staff, including assessment teams;
- ▶ procurement officers and logisticians;
- ▶ sector and cross-cutting specialists, including WASH, recovery, protection, gender and environment; and
- ▶ programme and project staff with their technical advisors will need to coordinate and communicate construction clearly with all other stakeholders, so that each can fulfil their role fully.



23. The private sector, nationally, regionally and internationally, needs to understand the process of transitional shelter so that the strategy is coordinated and well supported. Stakeholders to consider include:

- ▶ manufacturers of materials, such as timber and plastic sheeting;
- ▶ materials wholesalers and suppliers, including logistics;
- ▶ materials distributors, including small shops;
- ▶ construction industry professional and trade bodies, such as institutes and guilds;
- ▶ construction industry professionals, such as surveyors, engineers and architects;
- ▶ construction industry companies and contractors, such as for site surveying and general works; and
- ▶ construction industry trades, such as carpenters, plumbers and masons.

## WHAT IS NOT IN THESE GUIDELINES

24. These guidelines emphasise that transitional shelter is not appropriate for all shelter responses. It does not go into detail on alternative methods.

25. The guidelines do not lessen the need for specialist technical activities such as multi-hazard assessments, structural engineering calculations, or support cross-cutting issues such as protection and the environment.

26. Instead, the publication seeks to identify when alternatives and specialists may be required and, where possible, guides the audience to other appropriate publications.

## EXPLANATION OF GRAPHICS

» 5.1

Refers to both the chapter number and section within the chapter where further information can be found on the subject in question.

 Oxfam, 2010. *TSDP*.

Refers to external resources, books, documents, publications, tools and website resources that were used in the production of these guidelines.

 Chris Lom/IOM

Refers to the individual, agency and/or organisation responsible for the photograph.

 **Attention:** careful observation is required.

 **Tip:** provides technical facts and information.

 **Field experience:** provides lessons learned and good practice from field practitioners and crisis situations worldwide.

 **Case study:** provides description and analysis of specific projects to illustrate the content of these guidelines.

1

definition of TS  
10 TS principles

definition

5 characteristics  
when not to use TS  
SWOT

2

decision-making tool

tool

3

coordination  
programme plan  
assessment  
beneficiaries  
labour  
materials  
procurement  
support  
quality assurance

programme

4

community  
site selection  
site planning  
land tenure  
handover

site

5

socio-cultural  
minimise risk  
climatic design  
materials  
construction

design

resources

# 1

# INTRODUCTION TO THE TRANSITIONAL SHELTER PROCESS

## Chapter contents

---

<b>1.1</b>	<b>WHAT IS TRANSITIONAL SHELTER?</b>	
1.1.1	The definition	2
1.1.2	Transitional shelter as part of a comprehensive strategy	4
1.1.3	Frequently asked questions	5
<b>1.2</b>	<b>10 PRINCIPLES OF TRANSITIONAL SHELTER</b>	
1.2.1	10 principles of transitional shelter	10
<b>1.3</b>	<b>THE 5 CHARACTERISTICS OF TRANSITIONAL SHELTER</b>	
1.3.1	The 5 characteristics of transitional shelter	15
<b>1.4</b>	<b>WHEN IS TRANSITIONAL SHELTER NOT APPROPRIATE?</b>	
1.4.1	Alternative shelter approaches	17
<b>1.5</b>	<b>TRANSITIONAL SHELTER SWOT ANALYSIS</b>	
1.5.1	SWOT analysis considerations	19





# 1.1

# WHAT IS TRANSITIONAL SHELTER?

## Introduction

1. This section will give a clear definition of the transitional shelter approach. It will address the common misconceptions of transitional shelter. At the end, a common understanding of transitional shelter will have been established laying the foundation for further elaborations on the transitional approach.

2. Since the 2004 Indian Ocean tsunami, transitional shelter has become an increasingly common term used by humanitarian actors to describe their response to post-disaster emergency shelter and reconstruction projects. A variety of very different approaches are being encompassed by the term. This has included overseas procured prefabricated structures, construction of semi-permanent shelters, core housing and the supply of tents, none of which are transitional shelter within the definition agreed through these guidelines.

## 1.1.1

## THE DEFINITION

### Definition

3. This publication defines the transitional shelter approach as:

**Transitional shelter is an incremental process which supports the shelter of families affected by conflicts and disasters, as they seek to maintain alternative options for their recovery. Through its five characteristics, transitional shelter can be:**

- (1) upgraded into part of a permanent house;
- (2) reused for another purpose;
- (3) relocated from a temporary site to a permanent location;
- (4) resold, to generate income to aid with recovery; and
- (5) recycled for reconstruction.

**The process starts with the first support offered to families and extends over the period of securing land rights and reconstruction, which may take several years.**

**For tenants, the process is appropriate only when land rights and safe shelter close to their livelihoods cannot be achieved immediately. For owners, the process should be considered only when repairs or reconstruction cannot start immediately.**

**The process should only be considered as part of the ongoing development and maintenance of a coordinated, integrated and comprehensive inter-sector strategy for shelter, settlement and reconstruction.**

4. "Reconstruction [...] begins immediately after the disaster."  
 The World Bank, 2010. *Safer Homes, Stronger Communities*, p.7.

1

definition of TS

10 TS principles

5 characteristics

when not to use TS

SWOT

2

decision-making tool

3

coordination

programme plan

assessment

beneficiaries

labour

materials

procurement

support

quality assurance

4

community

site selection

site planning

land tenure

handover

5

socio-cultural

minimise risk

climatic design

materials

construction

definition

tool

programme

site

design

resources

5. Diagram 1.1 below shows an incremental transitional shelter process compared with a multi-phased approach.

**Diagram 1.1**  
Transitional shelter as an incremental process

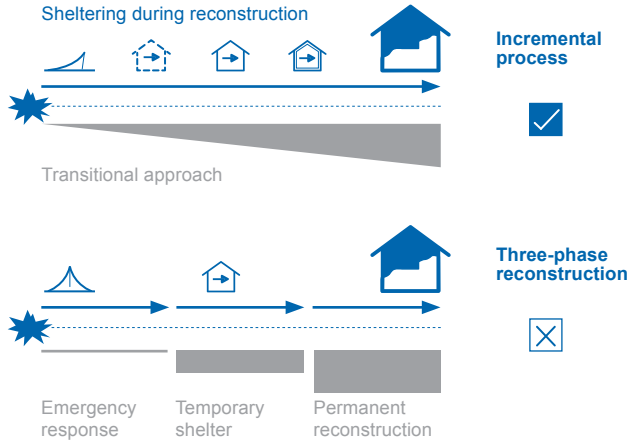

**Multi-phased approach**

6. Reconstruction often takes several years. The transitional shelter approach aims to initiate and support a sustainable, beneficiary driven process of constructing culturally appropriate shelter at the beneficiaries' individual pace.

7. Transitional shelter commences with immediately distributing relief items post disaster. These relief items will be, wherever possible, reused in the future steps of an incremental transitional shelter response.

8. Diagram 1.2 below shows transitional shelter in the response cycle.

**Diagram 1.2**  
Transitional shelter in the response cycle

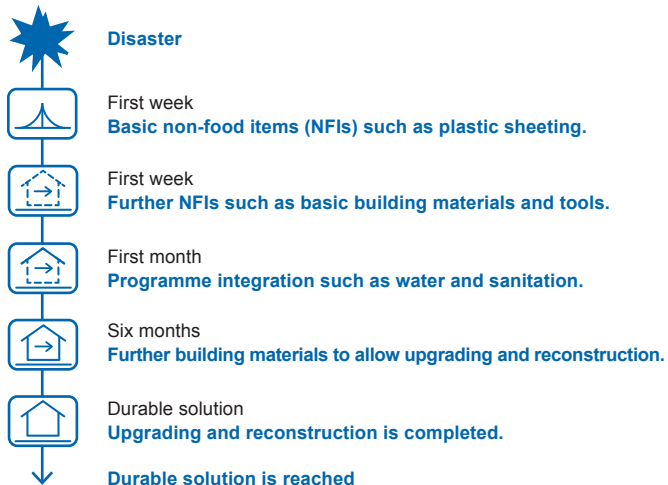

**Settlement options**







**Choice of settlement options**

**Categorising settlement options**

**Table 1.1**  
The six settlement options for displaced populations

9. It is imperative that the humanitarian response targets the entire affected population, and is prioritised according to their level of vulnerability and the impact of the disaster.
10. Transitional shelter can support displaced populations as part of a transitional settlement programme or can support non-displaced populations as part of a transitional reconstruction programme.
11. Whether displaced or non-displaced, people choose a variety of different options for their settlement, depending on circumstances. For example, a displaced family may be able to stay with a host family, but if this option is not possible then they may settle in a planned camp.
12. The settlement options for displaced and non-displaced populations can be categorised into six transitional settlement options and six transitional reconstruction options which outline the context in which the affected families are settled following a disaster.
13. Table 1.1 below shows the six settlement options for displaced populations.

**Table 1.1 The six settlement options for displaced populations**

<i>Option 1</i>	 <p><b>Host families</b></p> <p><b>Definition:</b> local families shelter the displaced population within their households or on their properties.</p>
<i>Option 2</i>	 <p><b>Urban self-settlement</b></p> <p><b>Definition:</b> unclaimed urban properties, or land unaffected by the disaster, are used informally by displaced populations.</p>
<i>Option 3</i>	 <p><b>Rural self-settlement</b></p> <p><b>Definition:</b> displaced populations create a settlement on collectively owned rural land.</p>
<i>Option 4</i>	 <p><b>Collective centres settlement</b></p> <p><b>Definition:</b> existing large structures, such as schools, can serve as collective shelters.</p>
<i>Option 5</i>	 <p><b>Self-settled camps</b></p> <p><b>Definition:</b> independent from government or international organisation support, camps are formed by the displaced population.</p>
<i>Option 6</i>	 <p><b>Planned camps</b></p> <p><b>Definition:</b> government or aid organisations plan camps, including infrastructure, to house displaced populations.</p>





UN, 2010. *Shelter After Disaster (SAD)*, p6.

1	definition
	<ul style="list-style-type: none"> <li>definition of TS</li> <li>10 TS principles</li> <li>5 characteristics</li> <li>when not to use TS</li> <li>SWOT</li> </ul>
2	tool
	<ul style="list-style-type: none"> <li>decision-making tool</li> </ul>
3	programme
	<ul style="list-style-type: none"> <li>coordination</li> <li>programme plan</li> <li>assessment</li> <li>beneficiaries</li> <li>labour</li> <li>materials</li> <li>procurement</li> <li>support</li> <li>quality assurance</li> </ul>
4	site
	<ul style="list-style-type: none"> <li>community</li> <li>site selection</li> <li>site planning</li> <li>land tenure</li> <li>handover</li> </ul>
5	design
	<ul style="list-style-type: none"> <li>socio-cultural</li> <li>minimise risk</li> <li>climatic design</li> <li>materials</li> <li>construction</li> </ul>
resources	

14. Table 1.2 below shows the six reconstruction options for non-displaced populations.

**Table 1.2**  
The six reconstruction options for non-displaced populations

**Table 1.2 The six reconstruction options for non-displaced populations**

Option 1	<b>Occupancy with no legal status</b>
	<b>Definition:</b> the occupant informally lives on property without the explicit permission of the owner.
Option 2	<b>House tenant</b>
	<b>Definition:</b> the occupant rents housing and land from the owner in a formal or informal arrangement.
Option 3	<b>Apartment tenant</b>
	<b>Definition:</b> the apartment is rented by the occupant formally or informally.
Option 4	<b>Land tenant</b>
	<b>Definition:</b> the occupant rents land but owns the house.
Option 5	<b>Apartment owner-occupier</b>
	<b>Definition:</b> the occupants own their apartment, a self-contained housing unit that occupies only part of a building, formally or informally.
Option 6	<b>House owner-occupier</b>
	<b>Definition:</b> the occupant owns or partially owns the house and land. This includes a mortgage or a loan as well as formal and informal ownership agreements.

 The World Bank, 2010. *Safer Homes, Stronger Communities*.  
 UN, 2010. *SAD*.  The Sphere Project, 2011. *The Sphere Handbook*.

### 1.1.3 FREQUENTLY ASKED QUESTIONS

15. The debate on transitional shelter includes a number of significant misconceptions. In order to convey the given definition of transitional shelter, this section will answer the most common critical questions concerning the approach.

#### The transitional shelter debate

16. There are a wide range of views in the humanitarian sector on the effectiveness of transitional shelter, from those who promote it as an effective participatory process that assists beneficiaries in rebuilding their homes, to those who strongly oppose it believing it to be an expensive, damaging product that diverts funds away from permanent reconstruction efforts. These concerns over the effectiveness and impact of transitional shelter are however, founded more on a lack of understanding of the transitional shelter approach, its definition and how it differs from other reconstruction methods.



## What are the misconceptions of the term “transitional”?



**Two common misconceptions of the transitional shelter approach are A. considering it as a product and B. using the term to describe another approach.**

A. Transitional shelter is sometimes misunderstood as a product and not a process, whereby a complete shelter is built at one time, rather than incrementally from the emergency phase using all of the shelter materials distributed. This misunderstanding introduces another phase, slowing down the response, and often wastes the materials distributed in the previous phase. » 1.1.1

B. Transitional shelter is sometimes used mistakenly to describe approaches to permanent reconstruction, such as core housing, sites and services, and one room shelter responses. » 1.4.1



## Why is transitional shelter such a costly approach?



**Transitional shelter is not a costly approach if implemented correctly.**

It usually takes two to fifteen years to resolve land rights in order to reconstruct homes damaged by conflict or disaster. Transitional shelter offers a cost effective approach to accommodate families over this period of time. If tents were used as an alternative, two to fifteen tents would be required to accommodate a family over the same period of time. In addition living conditions in tents greatly affect the recovery of livelihoods leading to further indirect costs. Though the initial start-up costs of a transitional shelter approach may appear high, the approach offers a beneficiary-driven reconstruction process that quickly becomes self-supporting through direct investment into local economies. It often provides livelihood opportunities which are proven to speed up the recovery process and quickly reduces dependency on external assistance. When appropriately applied, the transitional approach becomes a more cost effective way to rebuild.

It is essential that transitional shelter is implemented as soon as it is deemed appropriate. Failure to establish the process quickly can add another costly phase to the response.

1

definition of TS  
10 TS principles  
5 characteristics  
when not to use TS  
SWOT

definition

2

decision-making tool

tool

3

coordination  
programme plan  
assessment  
beneficiaries  
labour  
materials  
procurement  
support  
quality assurance

programme

4

community  
site selection  
site planning  
land tenure  
handover

site

5

socio-cultural  
minimise risk  
climatic design  
materials  
construction

design

resources

17. Diagram 1.3 below conveys the idea of how a transitional shelter approach can be more cost effective over time.

**Diagram 1.3**  
Transitional shelter and cost

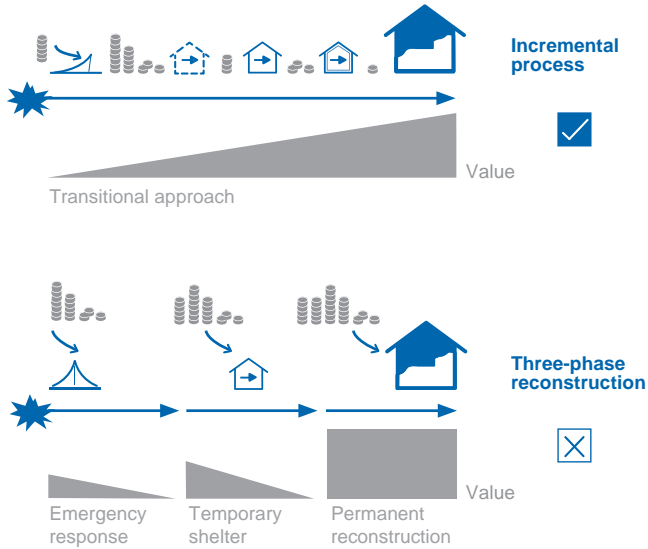

**Can transitional shelter help solve land tenure problems?**



**Yes, transitional shelter is a tool to help solve land tenure problems, in that once affected families are in safe and durable shelters, the appropriate time can be taken to resolve land tenure sustainably.**

Land tenure needs to be secured through legal means using land tenure specialists who can liaise with government officials and host country legal teams. Transitional shelter can sometimes provide additional options for beneficiaries. For example, it may enable them to physically relocate their shelters if threatened by eviction, but it cannot be used to solve this often very complex and political issue. >>4.4



**Case study: Sri Lanka tsunami, 2004—Land tenure**

Communities in Sri Lanka affected by the 2004 Indian Ocean tsunami established a transitional shelter programme in cooperation with local and national authorities. Reconstruction began on the beneficiaries original plots, even though clear proof of ownership could not be provided. The government ultimately provided land rights to each of the beneficiaries

allowing them to finish the reconstruction but this achievement is an example of strong cooperation between government and landowners and not the transitional shelter approach itself.

UN-HABITAT, 2008. *Shelter Projects*, p.67–68.



### Case study: Haiti earthquake, 2010—Land tenure

In contrast to Sri Lanka, Haitian private landowners are strong, which has stalled the resolution of land rights and tenure. This has resulted in the eviction of transitional shelter beneficiaries as private landowners grow tired of the unresolved situation. This clearly shows the transitional shelter approach is unable to secure land tenure. However, it does allow the beneficiaries to relocate, and not lose their shelters. UN-HABITAT, 2010. *Strategic Citywide Spatial Planning*, p.21.



### Are prefabricated shelters transitional shelters?



**No, prefabricated shelter units are not appropriate for a transitional shelter approach.**

Prefabricated shelter units are often sourced internationally and do not involve the community in the design of both the programme and the shelters themselves. Case studies have shown that some prefab programmes have exceeded the cost of a permanent reconstruction approach. Prefabricated shelter is often perceived as a transitional shelter approach and therefore skews the debate in regard to the cost of transitional shelter. Prefabrication of entire shelter units is not an incremental process of sheltering and is therefore not a transitional shelter approach. » 1.1.1



### What is the difference between transitional shelter and “core housing”?



**Core housing, sometimes called one room shelter (ORS) in Pakistan, starts with the complete construction of one room of the permanent house, offering shelter until the rest of the house is finished. In addition, certain complementary structures such as foundations or latrines may also be constructed.**

Although core housing eventually gets “extended” into a permanent house, the approach does not allow reuse for another purpose, the relocation to another site or recycling of components for permanent reconstruction. In addition it is also unlikely that specific parts of a core house can be resold. » 1.4.1

1

definition of TS

10 TS principles

5 characteristics

when not to use TS

SWOT

2

decision-making tool

3

coordination

programme plan

assessment

beneficiaries

labour

materials

procurement

support

quality assurance

4

community

site selection

site planning

land tenure

handover

5

socio-cultural

minimise risk

climatic design

materials

construction

definition

tool

programme

site

design

resources

18. These common questions asked by the shelter community in this section reveal a general lack of understanding on the definition of transitional shelter. Through the answers to these questions the misconceptions of what transitional shelter is and what it is not have been clarified. The following section will further elaborate on the transitional shelter approach through the introduction of the 10 transitional shelter principles.





1.2

# 10 PRINCIPLES OF TRANSITIONAL SHELTER

10 transitional shelter principles

19. This section presents the 10 transitional shelter principles that will allow shelter practitioners to assess whether a transitional shelter approach is appropriate. These principles expand this publication's definition of transitional shelter as introduced in the previous section.

1.2.1

## 10 PRINCIPLES OF TRANSITIONAL SHELTER



**ASSESS SITUATION**



**INVOLVE COMMUNITY**



**DEVELOP STRATEGY**



**REDUCE VULNERABILITY**



**AGREE STANDARDS**



**MAXIMISE CHOICE**



**BUY TIME**



**INCREMENTAL PROCESS**



**PLAN SITE**



**RECONSTRUCTION**

1

definition of TS  
10 TS principles

5 characteristics  
when not to use TS  
SWOT

definition

2

decision-making tool

tool

3

coordination  
programme plan  
assessment  
beneficiaries  
labour  
materials  
procurement  
support  
quality assurance

programme

4

community  
site selection  
site planning  
land tenure  
handover

site

5

socio-cultural  
minimise risk  
climatic design  
materials  
construction

design

resources



---

Transitional shelter will not be an appropriate shelter response in all situations or for all people affected in any situation. A number of different approaches exist for providing shelter in post-disaster or post-conflict situations and comprehensive assessments should be undertaken to understand the potential strengths, weaknesses, opportunities and threats of all shelter responses prior to selecting the most appropriate.

---



Invariably, the greatest effort in a response is made by those affected. They are also most aware of the most appropriate, sustainable and rapid routes to recovery. The greater the involvement of the community in implementation, the more efficient and cost effective the response will be.

---



Transitional shelter programmes should be used to support the appropriate groups within the affected population for a period of time. This should be part of a comprehensive inter-sector shelter strategy that considers camp coordination and camp management (CCCM), early recovery, health, protection and WASH issues, in addition to cross cutting issues, to support the entire population, both displaced and non-displaced, until durable shelter solutions are reached.

---



Transitional shelter programmes should reduce the vulnerability of the affected population and contribute to disaster risk reduction by using site selection, site preparation, shelter design and construction as a platform for communicating hazard resilient techniques and best practice and by building capacity within the affected population.

---



There is no standard transitional shelter design. Standards should be agreed upon, with participation from the affected population, which are appropriate for each beneficiary group. Standards should consider the implication of local hazards, climate, available labour and skills, available material, traditional building practices, cultural requirements and social and household activities.

---

## Sri Lanka tsunami, 2004

► The transitional approach was deemed necessary as the UN and other organisations predicted the populations would be living in the provided shelters for some years to come, due to the scale of the disaster and due to the need to support livelihoods. Tents were not deemed durable enough to last over the estimated timespan between emergency shelter and permanent housing.

📖 UN-HABITAT, 2008. *Shelter Projects*, p.67–68.



## Jogyakarta Indonesia earthquake, 2004

► In Jogyakarta the local community was involved in the transitional shelter programme based on the Javanese self-help cultures of *gotong royong*, or “working bee”, leading to material distribution at the community instead of individual level. In addition, the communities were also responsible for beneficiary selection.

📖 UN-HABITAT, 2008. *Shelter Projects*, p.42–51.



## Haiti earthquake, 2010

► Some transitional shelter programmes implemented after the 2010 earthquake in Haiti successfully emphasised the preliminary assessment of WASH facilities, demonstrating successful coordination and close cooperation with organisations concerning this issue.

📖 Cordaid/Caritas, 2010. *Haiti earthquake, 2010—Shelter design with the community*.



## Haiti earthquake, 2010

► In the 2010 Haiti earthquake response, transitional shelters were designed to withstand hurricanes expected during the rainy season. Beneficiaries were trained in hurricane-resilient roof construction using hurricane straps to hold down trusses and purlins, and disaster risk reduction principles to support later reconstruction.

📖 Cordaid/Caritas, 2010. *Haiti earthquake, 2010—Shelter design with the community*.



## Peru earthquake, 2007

► The transitional shelter design was agreed on by showcasing to beneficiaries three prototypes constructed by local carpenters.

► In the next step, the community adapted and implemented their chosen design in a pilot project which finally led to commonly agreed design and standards.

📖 UN-HABITAT, 2008. *Shelter Projects*, p.77.



1

definition of TS  
10 TS principles  
5 characteristics  
when not to use TS  
SWOT

definition

2

decision-making tool

tool

3

coordination  
programme plan  
assessment  
beneficiaries  
labour  
materials  
procurement  
support  
quality assurance

programme

4

community  
site selection  
site planning  
land tenure  
handover

site

5

socio-cultural  
minimise risk  
climatic design  
materials  
construction

design

resources



The combination of shelter and settlement options used by each household on the path to a durable shelter solution, and the rate of their recovery, will vary as a result of their different needs and resources. The design and construction of the shelters themselves should maximise the choice of shelter and settlement options for each household by allowing beneficiaries to recycle, upgrade, reuse, resell and relocate their shelters as required, and through the selection of assistance methods provided.



Sustainable reconstruction following a major conflict or disaster can take a number of years to complete; longer than the usual life-span of plastic sheeting and tents. Aspects of responses such as community participation, securing land tenure and the agreement of standards take time to initiate and complete, however if rushed may result in inequality, poor sustainability and greater vulnerability. Transitional shelter is one approach to supporting shelter needs while sustainable reconstruction is taking place.



The process of sheltering should start with the first distribution of relief items and offer opportunities for incremental upgrading, reusing, reselling or recycling by beneficiaries at their own pace until durable shelter solutions are achieved. Transitional shelter should not be viewed as an additional phase of a response: emergency shelter followed by transitional shelter succeeded by reconstruction is not a transitional shelter process. Transitional shelter begins as the initial response and in parallel to reconstruction.



Beneficiaries of transitional shelter programmes should be located on land that is safe, legal and appropriate. This may be achieved through site planning involving the integration of hazard risk reduction, zoning and service integration. Site planning should consider the whole community and its needs, and is important for both displaced and non-displaced populations in urban and rural settings.



Transitional shelter programmes should be implemented at the same time as permanent reconstruction programmes. The shelters themselves should be designed to complement and contribute to a reconstruction programme through the process of being upgraded, reused, recycled or resold.

### Jogyakarta Indonesia earthquake, 2004

► Beneficiaries were recommended to apply the developed design in order to maintain optimised safe building standards. However the programme did not insist on it, giving certain regional groups with elaborate construction skills and local construction resources the chance to modify the design according to their specific needs.

📖 UN-HABITAT, 2008. *Shelter Projects*, p.42–51.



### Sri Lanka tsunami, 2004

► Immediately after the tsunami in Sri Lanka, temporary shelter was organised in public buildings such as temples, or with host families. In the time that followed, many were able to make basic repairs to their homes, while others moved into transitional shelters while reconstruction progressed.

📖 UN-HABITAT, 2008. *Shelter Projects*, p.64–66.



### Haiti earthquake, 2010

► After the earthquake in Haiti some transitional shelters started with simple methods of covering such as tarpaulins in order to shelter as many affected people as possible before the upcoming rainy season. In a next step of the incremental process further materials and training for upgrading were provided.

📖 Caritas/Cordaid, 2010. *Haiti earthquake, 2010—Shelter design with the community*.



### Jogyakarta Indonesia earthquake, 2004

► A public outreach programme was organised to educate beneficiaries on issues regarding safe rubble clearance and siting of transitional shelters. In addition, reconstruction took into consideration safety issues such as handling of asbestos or building next to hazardous buildings.

📖 UN-HABITAT, 2008. *Shelter Projects*, p.42–51.



### Aceh Indonesia tsunami, 2004

► The example of the transitional shelter programme implemented after the tsunami in Aceh, Indonesia shows that almost all beneficiaries still use their transitional shelters as businesses or additional living space after moving to permanent housing. In many cases materials were also recycled to contribute to permanent reconstruction.

📖 Batchelor, V, 2011. *Tarpaulins [...]*.



1

definition of TS  
10 TS principles  
5 characteristics  
when not to use TS  
SWOT

definition

2

decision-making tool

tool

3

coordination  
programme plan  
assessment  
beneficiaries  
labour  
materials  
procurement  
support  
quality assurance

programme

4

community  
site selection  
site planning  
land tenure  
handover

site

5

socio-cultural  
minimise risk  
climatic design  
materials  
construction

design

resources

20. This page introduces and explains the five characteristics of transitional shelter which enable shelter practitioners to outline the basic design of a transitional shelter and support the incremental process of the approach.

## 1.3.1

5 CHARACTERISTICS OF  
TRANSITIONAL SHELTER

## UPGRADABLE

While being inhabited, transitional shelter may be improved over time to become a permanent shelter solution. This is achieved through maintenance, extension or by replacing original materials for more durable alternatives.



## REUSABLE

Transitional shelter is inhabited while parallel reconstruction activities are taking place. Once reconstruction is complete, the transitional shelter may be used for an alternative function, for example as an external kitchen, barn or shop.



## RELOCATABLE

Relocation distinguishes transitional shelter from other shelter approaches. A relocatable shelter can be built on land where tenure is insecure or temporary. If land tenure issues are resolved on another site, the transitional shelter, or valuable parts of it, may be relocated to the permanent location.



## RESALEABLE

Transitional shelter is inhabited while parallel reconstruction activities are taking place. Once reconstruction is complete, the transitional shelter may be dismantled and its materials used as a resource to sell. Therefore, the materials and their fixings need to be selected so that they will be suitable for dismantling and resale.



## RECYCLABLE

Transitional shelter is inhabited while parallel reconstruction activities are taking place. The transitional shelter may be gradually dismantled during the reconstruction process and its materials used in the construction of a durable solution.



**Characteristic choice**

21. Each of the five characteristics enables different paths to recovery, so that the transitional shelter programme offers minimum constraints to the future choices of affected populations.

22. In some circumstances, one characteristic may appear more probable and the programme design and materials may be adapted accordingly. For example, in Yogyakarta, as land tenure was relatively clear it was probable that recycling would be the most valuable characteristic. Care should be taken, however, not to assume a single path to recovery, especially as the futures of various groups within the same affected community are likely to be different.

1

definition of TS  
10 TS principles  
5 characteristics

when not to use TS  
SWOT

definition

2

decision-making tool

tool

3

coordination  
programme plan  
assessment  
beneficiaries  
labour  
materials  
procurement  
support  
quality assurance

programme

4

community  
site selection  
site planning  
land tenure  
handover

site

5

socio-cultural  
minimise risk  
climatic design  
materials  
construction

design

resources



## 1.4

# WHEN IS TRANSITIONAL SHELTER NOT APPROPRIATE?

### Two possible scenarios

23. This section is applicable when assessing the two following scenarios:

A. when transitional shelter is being considered as a possible approach, as part of an integrated and comprehensive strategy and response with the affected population; and

B. when transitional shelter has already been selected as part of the programme strategy, however this decision should be reviewed in the light of more detailed assessment, for all or part of the intended group to be supported.

### A three-step assessment

24. This section will enable shelter practitioners to assess when a transitional shelter approach is or is not appropriate. Three steps may be taken for this assessment for both scenarios A and B.

(1) The decision-making tool presented in chapter 2, should be used to determine whether a transitional shelter is likely to be appropriate. »2

(2) The ten transitional shelter principles should be reviewed in the context of the programme intended. »1.2

(3) Strengths weaknesses opportunities threats (SWOT) analysis should be undertaken specific to the context where the transitional shelter programme is being considered or implemented, referring as general guidance only to the SWOT analysis in section. »1.5

25. If transitional shelter is not an appropriate approach to support the six options for displaced families or six options for families that have not been displaced, presented in section »1.1.2, then alternative approaches may be considered. These can be seen in the following section.

## 1.4.1

## ALTERNATIVE SHELTER APPROACHES

### Alternative approaches

26. For families that have not been displaced, or those which have returned, example alternative approaches for consideration may include the following.

#### Semi-permanent shelter

27. Building parts of some elements of a house, such as foundations and a roof, in order to offer shelter while the remainder of the house is completed. This approach may require parts of the shelter to be disassembled in order to complete reconstruction.



## Sites and services

28. Preparing the site for the permanent house and all wet services and utilities, such as the bathroom, sewage and electrical supply, in order to: accelerate the process of reconstructing the remainder of the house; offset the costs payable by the owner; and increase the quality of planning as well as provision for common services and for maintaining hygiene.

### Core house or one room shelter (ORS)

29. Building at least one complete room of a final house, in order to offer shelter while the remainder of the house is completed. Beyond a single room, this approach may also build part of the rest of the house, such as the foundations, or all or parts of key services, such as the latrine or connection to utilities.



#### Case study: Pakistan floods, 2010—ORS response

After the floods in 2010, the IASC Shelter Cluster in Pakistan recommended a core housing or ORS response for families who were able to return to their original locations. This represented approximately 80% of the total affected population. Social mobilisation and mass communication strategies were used to help beneficiaries to directly participate in the reconstruction of one habitable room. Selected materials, technical expertise and/or skilled labour were provided by implementing partners to assist the efforts of beneficiaries.

📖 IOM, 2011. *ORS—One Room Shelter Programme Manual*, p.6–12.



Involve main stakeholders in the SWOT

30. Undertaking a SWOT analysis specific to the operational context is valuable at any time within a transitional shelter programme.

31. With proper consultation, a limited SWOT analysis can be completed very rapidly, even in a matter of hours. Greater participation and more detailed analysis will, however, give better results. Ideally a SWOT analysis should involve the affected community, the government and project staff in a series of independent meetings.

32. Common weaknesses and threats for transitional shelter are summarised in the next section. However, the following additional considerations may be important to consider also when undertaking a SWOT analysis specific to a context in order to determine when transitional shelter may not be appropriate.

1

definition of TS  
10 TS principles  
5 characteristics  
when not to use TS

SWOT

2

decision-making tool

3

coordination  
programme plan  
assessment  
beneficiaries  
labour  
materials  
procurement  
support  
quality assurance

4

community  
site selection  
site planning  
land tenure  
handover

5

socio-cultural  
minimise risk  
climatic design  
materials  
construction

definition

tool

programme

site

design

resources

## 1.5.1 SWOT analysis considerations

### **S**trengths of transitional shelter

- ▶ **Transitional shelter spans the entire reconstruction period**, from disaster until a permanent solution is achieved.
- ▶ **Transitional shelter offers a better living space than a tent** for activities such as childcare, cooking and home-based enterprises.
- ▶ **A secure, healthy living environment** that offers dignity and privacy can be provided through transitional shelter.
- ▶ **Shelter beneficiaries are involved** in the decision-making process, ensuring that structures are built at a speed which does not disrupt their livelihoods, using familiar materials and construction techniques.
- ▶ **Land rights issues can be negotiated** in parallel to transitional shelter construction, as land may be used on a temporary basis until disputes are resolved.
- ▶ **Transitional shelter materials are procured from the local economy**, creating livelihood opportunities and reducing dependency on external assistance.
- ▶ **Large numbers of transitional shelters can be built incrementally after large disasters**, because common local and regional materials are used, unlike tents.
- ▶ **Materials used may be recycled, upgraded, reused, resold or relocated** after construction.

### **O**pportunities of transitional shelter

- ▶ **Materials may be salvaged** from damaged or destroyed homes and reused in transitional shelter construction.
- ▶ **Materials from the first distribution are part of the transitional shelter design**, rather than distributing materials in phases, such as a shelter kit followed by a tent.
- ▶ **A transitional shelter may be relocated** from a transitional settlement site to a transitional reconstruction site.
- ▶ **Transitional shelters may be innovatively reused** during or after reconstruction, such as a shop or livestock shelter.
- ▶ **Economic recovery may be accelerated** by using local business to supply building materials and labour.
- ▶ **Building back better is encouraged** by demonstrating simple construction techniques, such as cross-bracing and hurricane straps that support building back more safely.

## Weaknesses of transitional shelter

- ▶ **A transitional shelter programme may raise false expectations within affected communities.** Beneficiaries may assume that everyone is entitled to a transitional shelter.
- ▶ **It may divert focus from a holistic support to affected communities.** Transitional shelter programmes may only concentrate on short-term deliverables.
- ▶ **It may offer less time and scope to disseminate sustainable building techniques to beneficiaries.**
- ▶ **Later stages of building transitional shelters may be delayed by the availability of materials,** following the initial distribution of materials such as plastic sheeting and fixings.
- ▶ **Significant human resources are often required** to coordinate the acquisition of building materials, the required technical reconstruction skills and community input.
- ▶ **Tents will be cheaper if shelter is needed for a short period.** However, if shelter is required for longer than the lifespan of a tent, which is usually less than a year, transitional shelter may be more cost effective.

## Threats of transitional shelter

- ▶ **There may not be sufficient resources to complete the reconstruction of the permanent house,** leaving affected families in transitional shelters.
- ▶ **Transitional shelter may be poorly implemented** if there is insufficient skill, technical capacity or cross-sector coordination. This can result in unsafe practices.
- ▶ **The prices of key materials may be inflated** when demand outstrips supply, or as a result of profiteering practices.
- ▶ **Transitional settlement sites may become slums** if an exit strategy is not developed, or if sites are not managed or decommissioned properly.
- ▶ **Local resources may be overexploited,** for example, timber may be sourced from unsustainable sources.

1

definition of TS

10 TS principles

5 characteristics

when not to use TS

SWOT

2

decision-making tool

3

coordination

programme plan

assessment

beneficiaries

labour

materials

procurement

support

quality assurance

4

community

site selection

site planning

land tenure

handover

5

socio-cultural

minimise risk

climatic design

materials

construction

definition

tool

programme

site

design

resources

# 2 DECISION-MAKING TOOL

This tool is a decision tree, structured in the following four sections:

- ▶ (A) Appropriateness
- ▶ (B) Internal capacities
- ▶ (C) Shelter properties
- ▶ (D) Assistance methods

The questions and considerations in this tool are designed to assist programme managers and technical specialists in asking the relevant questions when deciding whether a transitional shelter programme may be an appropriate shelter response.

The tool is to be used with full participation of the affected population to enable them to choose the best path to their own recovery.

In situations where the mandated coordination structure of the Inter-Agency Standing Committee cluster approach is in use, guidance from the cluster has to be considered in conjunction with this tool; however, shelter designs and specifications should be produced to meet the unique requirements of each beneficiary group.

The following settlement options outline the context in which the affected families are settled following a disaster.

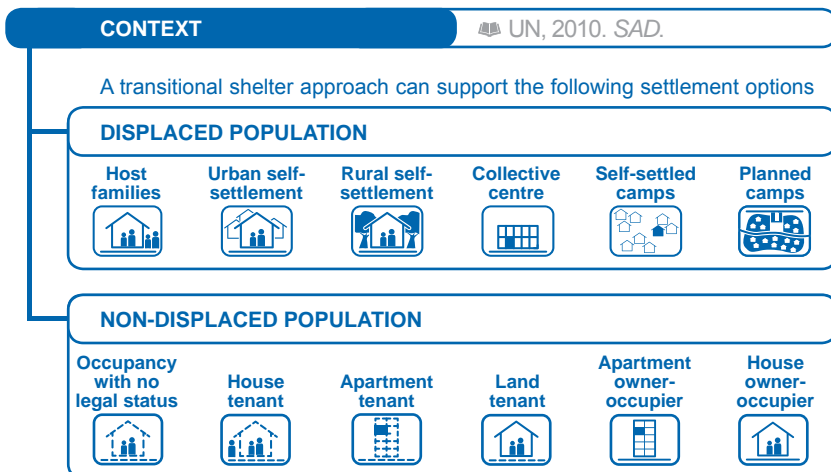

1

definition

**A** WOULD A TRANSITIONAL SHELTER APPROACH BE APPROPRIATE?

definition of TS  
10 TS principles  
5 characteristics  
when not to use TS  
SWOT

A1 TRANSITIONAL SHELTER

A2 OTHER SETTLEMENT OPTIONS

A3 OTHER SHELTER OPTIONS

2

tool

**B** ARE THE NECESSARY INTERNAL CAPACITIES AVAILABLE?

decision-making tool

B1 TECHNICAL CAPACITIES

B2 FINANCIAL CAPACITIES

3

programme

**C** WHAT PROPERTIES DO THE SHELTERS NEED TO HAVE?

coordination  
programme plan  
assessment  
beneficiaries  
labour  
materials  
procurement  
support  
quality assurance

C1 KEY PROPERTIES

C2 MINIMISING RISKS

C3 INTERNAL CONDITIONS

4

site

**D** WHAT ASSISTANCE METHODS SHOULD BE USED?

community  
site selection  
site planning  
land tenure  
handover

D1 LABOUR METHODS

D2 MATERIALS METHODS

D3 QUALITY ASSURANCE METHODS

D4 SUPPORT METHODS

5

design

socio-cultural  
minimise risk  
climatic design  
materials  
construction

resources

**A****WOULD A TRANSITIONAL SHELTER APPROACH BE APPROPRIATE?****B****ARE THE NECESSARY INTERNAL CAPACITIES AVAILABLE?**

The questions asked in this step are based on the ten transitional shelter principles. » 1.2

**A1****TRANSITIONAL SHELTER***Consider the following issues***A1.1****ASSESSMENT**

Have assessments been undertaken at a household level to ascertain whether the transitional shelter approach is appropriate? » 3.4

**A1.2****COMMUNITY**

Is it possible to involve the affected population throughout the planning and implementation of the transitional shelter programme? » 4.2

**A1.3****STRATEGY**

Would a transitional shelter programme contribute to an inter-sectoral strategy? » 3.2

**A1.4****VULNERABILITY**

Would a transitional shelter programme reduce the vulnerability of the target population? » 3.4

**A1.5****STANDARDS**

Can appropriate standards and design parameters be developed to meet the needs of each beneficiary group? » 3.9.2

**A1.6****MAXIMISE CHOICE**

Would a transitional shelter programme support the shelter and settlement choices made by the affected population throughout the transition to a permanent solution? » 1.1.2

**A1.7****BUY TIME**

Is it possible to commence sustainable reconstruction rapidly? » 1.1

**A1.8****INCREMENTAL PROCESS**

Can transitional shelter begin with the distribution of relief items and be developed incrementally until durable solutions are reached? » 1.1.1

**A1.9****SITE PLANNING**

Would the site selection and planning of the transitional shelter programme support the recovery of the target communities? » 4.1

**A1.10****RECONSTRUCTION**

Would the shelters themselves contribute to the permanent reconstruction programme? » 1.1.1

**YES**

If the answer to most of these questions is yes, then transitional shelter may be an appropriate response. Move on to decision B to ascertain if the necessary internal capacities are available.

**Go to decision B**



1

definition

definition of TS  
10 TS principles  
5 characteristics  
when not to use TS  
SWOT

2

tool

decision-making tool

3

programme

coordination  
programme plan  
assessment  
beneficiaries  
labour  
materials  
procurement  
support  
quality assurance

4

site

community  
site selection  
site planning  
land tenure  
handover

5

design

socio-cultural  
minimise risk  
climatic design  
materials  
construction

resources

NO

If the answer to several of these questions is no, then transitional shelter is unlikely to be the appropriate response. Consider other settlement and shelter responses from the options below.

A2

OTHER SETTLEMENT OPTIONS

UN, 2010. SAD.

A2.1

DISPLACED POPULATION

Can a temporary site be located for the affected population until reconstruction is appropriate? >> 1.1.2

Host families



Urban self-settlement



Rural self-settlement



Collective centre



Self-settled camps



Planned camps



Occupancy with no legal status



House tenant

Apartment tenant



Land tenant



Apartment owner-occupier



House owner-occupier



A2.2

NON-DISPLACED POPULATION

Can the beneficiaries use their land throughout the reconstruction period until a durable solution is reached? >> 1.1.2

It may be possible for populations to move between various settlement options in the process of reaching a durable solution.

A3

OTHER SHELTER OPTIONS

UN, 2010. SAD.

A3.1

SEMI-PERMANENT SHELTER

Would it be possible to implement a "semi-permanent" shelter response? >> 1.4.1

A3.2

SITES AND SERVICES

Would it be possible to implement a "sites and services" response? >> 1.4.1

A3.3

CORE

Would it be possible to implement a "core" response? >> 1.4.1

A

WOULD A TRANSITIONAL SHELTER APPROACH BE APPROPRIATE?

B

ARE THE NECESSARY INTERNAL CAPACITIES AVAILABLE?

B1

**TECHNICAL CAPACITIES***Consider internal capacities*

B1.1

**HUMAN RESOURCES**

Are the necessary technical personnel available and/or can they be recruited in time? » 3.2.3

B1.2

**LOGISTICS CAPACITIES**

Do logistics capacities match the scope of the transitional shelter programme? » 3.2.3

B1.3

**PARTNER ORGANISATIONS**

Are local partners available to facilitate appropriate outreach to affected communities and support the programme after handover? » 3.2.3

B2

**FINANCIAL CAPACITIES***Consider internal capacities*

B2.1

**FUNDING**

Can sufficient funding be secured to support beneficiaries until a durable solution is reached? » 3.2.3

B2.2

**ACCOUNTING/ BUDGETING**

Are accounting structures in place to ensure budget items are met? » 3.2.3

Now that transitional shelter has been identified as an appropriate response, this step aims to assist programme managers and technical specialists in producing specifications for shelters in close cooperation with the affected population. This step should be revisited a number of times throughout a transitional shelter programme to update specifications as shelters are upgraded over the course of the transitional shelter programme.

C1

**KEY PROPERTIES***Consider the following issues*

C1.1

**LIFESPAN**

Is it possible to commence sustainable reconstruction rapidly and plan future upgrades? » 5.4

C1.2

**5 DESIGN CHARACTERISTICS**

Is the transitional shelter suitable for upgrading, reusing, relocating, reselling and/or recycling? » 1.3

C1.3

**COST**

What is the cost estimate of the transitional shelter? » 3.2.4

C1.4

**STANDARDS**

Does the transitional shelter design and construction adhere to existing standards? » 3.9

C1.5

**CULTURALLY APPROPRIATE**

Is the transitional shelter culturally appropriate? » 5.1

C1.6

**EQUITY OF RESPONSE**

Does the response approach avoid tensions between beneficiaries and non-beneficiaries? » 3.4



C

WHAT PROPERTIES DO THE SHELTERS NEED TO HAVE?

D

WHICH ASSISTANCE METHODS SHOULD BE USED?



C2

MINIMISING RISKS

Consider the project's location

C2.1

HAZARD RESISTANCE

Is the transitional shelter resilient/resistant to hazards? >>5.2

C2.2

CLIMATE AND WEATHER

Is the transitional shelter appropriate to climate and weather conditions? >>5.3

C2.3

SAFETY AND SECURITY

Is the transitional shelter safe and secure, and perceived to be so by beneficiaries? >>5.2

C3

INTERNAL CONDITIONS

Consider the living environment

C3.1

TEMPERATURE

Is the transitional shelter designed to replicate the internal temperature of traditional structures? >>5.3

C3.2

VENTILATION

Is the transitional shelter designed to replicate the ventilation properties of traditional structures? >>5.3

C3.3

INTERNAL SPACE

Does the transitional shelter match traditional internal space (height/floor area)? >>5.1

C3.4

PRIVACY

Does the transitional shelter offer privacy both within and between shelters? >>5.1

C3.5

VECTOR CONTROL

Does the transitional shelter prevent the entry of pests, mosquitoes and other disease vectors? >>5.2

Go to decision D

1

definition of TS  
10 TS principles  
5 characteristics  
when not to use TS  
SWOT

definition

2

decision-making tool

tool

3

coordination  
programme plan  
assessment  
beneficiaries  
labour  
materials  
procurement  
support  
quality assurance

programme

4

community  
site selection  
site planning  
land tenure  
handover

site

5

socio-cultural  
minimise risk  
climatic design  
materials  
construction

design

resources

Now that the properties have been considered, this step aims to assist programme managers in selecting appropriate labour, materials, quality assurance and support methods for transitional shelter programmes together with the affected population. All options in this section can be considered in parallel when preparing an overall disaster response.

**D1**

**LABOUR METHODS**

*Consider appropriate combination*

**D1.1 SELF-HELP**

Can transitional shelters be built by the beneficiaries themselves? » 3.5.1

**D1.2 COMMUNITY**

Can transitional shelter be built through community mobilisation? » 3.5.2

**D1.3 DIRECT**

Can transitional shelter be built by hiring local labour? » 3.5.3

**D1.4 CONTRACT**

Should transitional shelter be built using contractors? » 3.5.4

**D2**

**MATERIALS METHODS**

*Consider procurement options*

**D2.1 LOCAL**

Are appropriate materials readily available in local markets? » 3.6.3

**D2.2 PREFABRICATED PARTS**

Should transitional shelters be built using locally prefabricated parts? » 3.6.5

**D2.3 IMPORTED**

Should transitional shelters be built using imported building materials? » 3.6.4

**D2.4 CONSTRUCTION ITEMS**

Are power tools required to construct, upgrade and/or maintain the transitional shelter? » 3.6.1

**D3**

**QUALITY ASSURANCE METHODS**

*Consider available capacities*

**D3.1 TECHNICAL EXPERTISE**

Can sufficient and adequate supervision and technical expertise be provided to ensure that shelters are constructed to appropriate standards? » 3.9.2

**D3.2 CAPACITY BUILDING**

Would it be beneficial to invest in technical capacity building among the affected population? » 3.9.3



1

definition of TS  
10 TS principles  
5 characteristics  
when not to use TS  
SWOT

definition

2

decision-making tool

tool

3

coordination  
programme plan  
assessment  
beneficiaries  
labour  
materials  
procurement  
support  
quality assurance

programme

4

community  
site selection  
site planning  
land tenure  
handover

site

5

socio-cultural  
minimise risk  
climatic design  
materials  
construction

design

resources

D4

SUPPORT METHODS

Consider the following options

D4.1 CASH

Is it appropriate for transitional shelters to be implemented using direct distribution of cash to beneficiaries? » 3.8.1

D4.2 VOUCHERS

Is it appropriate for transitional shelters to be implemented using vouchers? » 3.8.2

D4.3 LOANS

Is it appropriate for transitional shelters to be implemented using loans? » 3.8.3

D4.4 MARKET SUPPORT

Can the existing markets and local suppliers be supported to help them provide sufficient materials for the programme? » 3.8.4

D4.5 LOCAL INFORMATION CENTRES

Would the establishment of local information centres be beneficial to offer advice on what assistance is available, and provide opportunities for consultation and participation? » 3.8.5

D4.6 ADVOCACY

Would access to advocacy, legal or administrative assistance for beneficiaries aid the project? » 3.8.6

D4.7 RETURN AND TRANSIT ITEMS

Would the provision of transport of materials for beneficiaries and/or transitional shelter support the affected population? » 3.8.7

D4.8 INFRA-STRUCTURE

Can infrastructure and settlement planning be implemented as part of the transitional shelter programme? » 3.8.8

D4.9 ENVIRONMENTAL MANAGEMENT

Is there a plan in place to deal with resource management and prevent negative environmental impacts? » 3.8.9

Ready to implement the programme

TRANSITIONAL SHELTER





# 3 PROGRAMME DESIGN AND IMPLEMENTATION

## Chapter contents

---

<b>3.1</b>	<b>TRANSITIONAL SHELTER AS PART OF A COORDINATED RESPONSE</b>	
3.1.1	Coordination structures	31
3.1.2	Coordination in smaller responses	32
3.1.3	Coordination in larger responses	33
3.1.4	Stakeholder roles and responsibilities	35
3.1.5	Coordination framework	37
3.1.6	Information management	40
<b>3.2</b>	<b>DEVELOPING A TRANSITIONAL SHELTER PROGRAMME PLAN</b>	
3.2.1	Developing a programme plan	44
3.2.2	Setting the objectives	46
3.2.3	Programme and project management	47
3.2.4	Planning tools	51
3.2.5	Exit strategy	54
<b>3.3</b>	<b>PROGRAMME ASSESSMENT</b>	
3.3.1	Stages of assessment	56
3.3.2	Who, what, where?	58
3.3.3	Identifying hazards and risks	59
3.3.4	Building damage	60
3.3.5	Impact on livelihoods and market assessment	61
<b>3.4</b>	<b>BENEFICIARY IDENTIFICATION</b>	
3.4.1	Agreeing criteria for identifying beneficiaries	64
3.4.2	Beneficiary selection	66
3.4.3	Balancing beneficiary numbers to level of assistance	67

<b>3.5</b>	<b>LABOUR METHODS</b>		<b>1</b>	<b>definition</b>
3.5.1	Direct labour	70		
3.5.2	Community labour	71		
3.5.3	International and national contract labour	72		
3.5.4	Self-help labour	74		
				10 TS principles
				5 characteristics
				when not to use TS
				SWOT
<b>3.6</b>	<b>MATERIALS METHODS AND SOURCING</b>		<b>2</b>	<b>tool</b>
3.6.1	Materials methods	76		
3.6.2	Sourcing materials	77		
3.6.3	Local sourcing	78		
3.6.4	International sourcing	79		
3.6.5	Prefabricated parts	80		
				coordination
				programme plan
				assessment
				beneficiaries
				labour
				materials
				procurement
				support
				quality assurance
<b>3.7</b>	<b>PROCUREMENT AND LOGISTICS</b>		<b>3</b>	<b>programme</b>
3.7.1	Introduction to procurement and logistics	82		
3.7.2	Market assessment	85		
3.7.3	Supply chain	86		
				labour
				materials
				procurement
				support
				quality assurance
<b>3.8</b>	<b>SUPPORT METHODS</b>		<b>4</b>	<b>site</b>
3.8.1	Cash	90		
3.8.2	Vouchers	91		
3.8.3	Insurances, loans and guarantees	91		
3.8.4	Market interventions	92		
3.8.5	Local information centres	93		
3.8.6	Advocacy, legal and administrative	93		
3.8.7	Return and transit items	94		
3.8.8	Infrastructure and settlement planning support	94		
3.8.9	Environmental and resource management	95		
				community
				site selection
				site planning
				land tenure
				handover
<b>3.9</b>	<b>QUALITY ASSURANCE</b>		<b>5</b>	<b>design</b>
3.9.1	Quality control	96		
3.9.2	Supervision and technical expertise	97		
3.9.3	Capacity building	98		
3.9.4	Monitoring and evaluation	99		
3.9.5	Community considerations	102		
3.9.6	Technical evaluation	103		
				socio-cultural
				minimise risk
				climatic design
				materials
				construction
				resources

1. This section summarises coordination structures including the IASC cluster approach, common coordination tools and activities, as well as information management, so that transitional shelter programmes can be integrated into the wider sector strategy and its implementation.

### 3.1.1 COORDINATION STRUCTURES

**Primary responsibility with national government**

2. In all responses, the national government has the primary responsibility for the development and implementation of a sector strategy, including for transitional shelter. The international humanitarian community engages and supports governments through different coordination systems, depending upon the size of the response and national circumstances.

**Coordination structure varies according to response needs**

3. The structure of coordination varies with each response, to respond to national structures and circumstances. This may be confusing for non-humanitarian stakeholders including affected communities, governments, the development community, the private sector, and national and international security forces. Transitional shelter programmes should support these stakeholders in understanding and participating in the coordination structure because coordination helps achieve comprehensive, appropriate and accountable support.

**Transitional shelter as part of the coordinating structure**

4. Transitional shelter programmes are usually included in the coordinating structure responsible for shelter for the displaced, unless the transitional shelters are grouped into camps, which often have different structures.

5. As transitional shelter is intended to accommodate families while reconstruction is taking place, strong links must be maintained with the coordinating structure responsible for the reconstruction and recovery activities. Transitional shelter seeks to support both displaced and non-displaced persons, as well as the gradual movement between these groups.

6. Links must also be maintained with their coordinating structures as all transitional shelter programmes should consider both legal protection, such as land rights and gender, and the water, sanitation and hygiene sector as determining factors in their design and implementation. Other cross-sector issues benefit from coordinated activities, especially the removal of rubble and environmental protection, for example managing the sustainable use of resources.

**Transitional shelter as part of a strategy**

7. Whatever coordination structure is in place, transitional shelter programmes should always be planned and implemented as part of the single coordinated strategy for the response, understanding that this may comprise a series of more specific sector strategies. Strategies are likely to contain a number of different approaches to support the shelter needs of the affected population and to support the six settlement and six reconstruction options »Chapter 1, such as camps or land tenants.

A post-disaster response strategy can be seen in UN, 2010. *SAD*, p.98.

8. If transitional shelter is identified as an appropriate shelter approach »Chapter 2, programmes should participate actively in the coordination of the response. This includes ensuring that regular updates are communicated to coordinators about progress and changes in circumstances, as well as contributing through programmes to meet the aims of effective coordination.

**Effective coordination**

9. Effective coordination aims to:
- ▶ engage the international community;
  - ▶ recognise national capabilities;
  - ▶ collectively negotiate with other entities i.e. government;
  - ▶ ensure the affected population are included in the decision-making process;
  - ▶ create a realistic vision and expectations;
  - ▶ distribute appropriate roles and responsibilities to all stakeholders;
  - ▶ agree on methods of gathering and sharing information and ensure their consistent use throughout the response;
  - ▶ eliminate possible gaps in participation, planning, funding and/or implementation;
  - ▶ reduce duplications across the response;
  - ▶ use resources efficiently; and
  - ▶ produce records to ensure greater accountability and transparency.

UN, 2010. *SAD*, p.7–8, 12.

**3.1.2 COORDINATION IN SMALLER RESPONSES**

**United Nations Resident Representative**

10. In small responses and some large responses, the international humanitarian community supports governments in developing and implementing the strategy through coordination under the United Nations Resident Representative, either using structures that have evolved over time, or structures developing during the response.

1

definition of TS  
10 TS principles  
5 characteristics  
when not to use TS  
SWOT

definition

2

decision-making tool

tool

3

coordination  
programme plan  
assessment  
beneficiaries  
labour  
materials  
procurement  
support  
quality assurance

programme

4

community  
site selection  
site planning  
land tenure  
handover

site

5

socio-cultural  
minimise risk  
climatic design  
materials  
construction

design

resources

11. Single agencies are usually appointed to lead different sectors. However, there is often a different agency leading the coordination of support to the shelter of the displaced and to the reconstruction of homes for those not displaced. Coordinating support to sectors such as camps and other options for grouped transitional settlement, protection and WASH may be integrated or they may each have their own structures and lead agencies.

### 3.1.3 COORDINATION IN LARGER RESPONSES

12. In many large responses, the international humanitarian community supports governments through the cluster approach under a Humanitarian Coordinator, reporting to the United Nations Office for the Coordination of Humanitarian Affairs, which itself represents the Inter-Agency Standing Committee. 📖 IASC, *Homepage* [online].

Humanitarian reform process

13. The cluster approach was implemented as one element of the “humanitarian reform process”, which was initiated in response to the 2005 IASC “Humanitarian Response Review” 📖 UN/OCHA, 2005. *Humanitarian Response Review*. The review highlighted a number of shortfalls in humanitarian response and proposed that a more comprehensive, timely and needs based response could be achieved by improving predictability, accountability, partnership and capacity.

Cluster approach

14. A cluster is a group of stakeholders with a common focus on a sector or service provided during a humanitarian crisis. The aim is to improve upon previous humanitarian response methods by encouraging sharing of expertise and pooling of resources. Although many clusters have a similar scope to traditional humanitarian sectors, such as logistics and health, what used to be called the shelter sector is broken up into the Emergency Shelter Cluster (ESC), the Camp Coordination and Camp Management Cluster (CCCM) and, for reconstruction, the Early Recovery Cluster (ERC). Transitional shelter programmes involve each of these three clusters. 📖 One Response, *Coordination* [online].

11 clusters and five cross-cutting issues

15. There are currently 11 global clusters, each led by a Global Cluster Lead Agency (GCLA), shown in Diagram 3.1. In addition, five cross-cutting issues have been identified and are shown in Table 3.1. 📖 One Response, *Coordination* [online].



**Diagram 3.1**  
11 global clusters and lead agencies

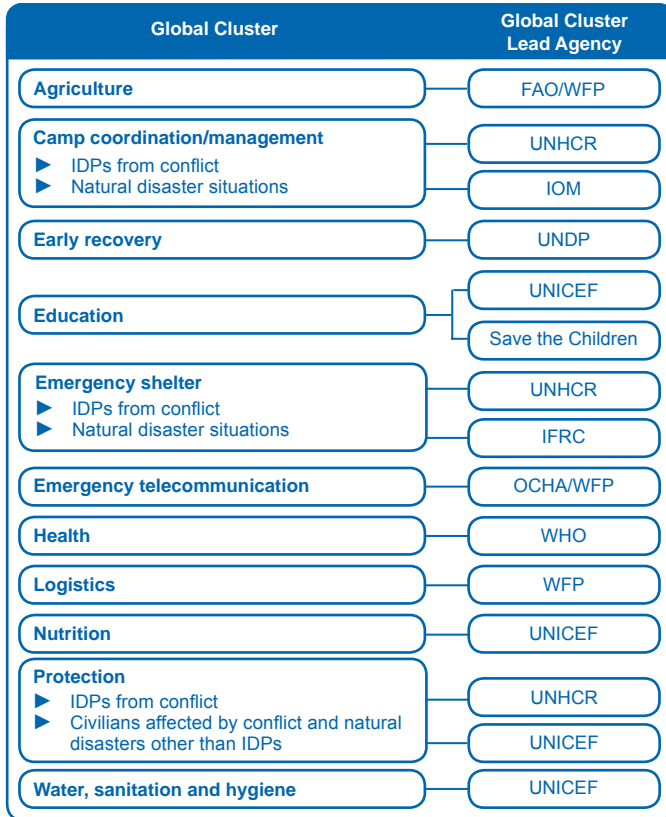

**Emergency Shelter Cluster**

16. At the global level the Emergency Shelter Cluster is co-chaired by the United Nations High Commissioner for Refugees and the International Federation of Red Cross and Red Crescent Societies. UNHCR leads in areas of conflict which generate refugees and internally displaced persons (IDPs). IFRC convenes the Emergency Shelter Cluster in disaster situations. 📖 IASC, *ShelterCluster.org* [online].

**Table 3.1**  
Five cross-cutting issues and associated lead agencies

Table 3.1 Five cross-cutting issues and associated lead agencies	
Cross-cutting issue	Global Cluster Lead Agency
Age	Help Age International
Environment	UNEP
Gender	IOM
HIV/AIDS	WFP/UNHCR
Mental health and psychosocial support	UNICEF

1

definition

definition of TS  
10 TS principles  
5 characteristics  
when not to use TS  
SWOT

2

tool

decision-making tool

3

programme

coordination  
programme plan  
assessment  
beneficiaries  
labour  
materials  
procurement  
support  
quality assurance

4

site

community  
site selection  
site planning  
land tenure  
handover

5

design

socio-cultural  
minimise risk  
climatic design  
materials  
construction

resources

17. In each response, once the cluster approach is activated by the United Nations Resident Representative, the GCLAs appoint the lead agencies for active clusters. The GCLAs may appoint a lead agency other than themselves. It is rare for all 11 clusters to be active except in large responses.

### 3.1.4 STAKEHOLDER ROLES AND RESPONSIBILITIES

#### Importance of identifying all stakeholders

18. “The contributions of non-governmental organizations (NGOs), civil society organizations (CSOs), and the private sector to reconstruction are critical. Besides managing core programs, these entities provide technical assistance, advocacy, and financial resources of enormous value.”  The World Bank, 2010. *Safer Homes, Stronger Communities*, p.2.

19. Key stakeholders roles and responsibilities are offered below.



20. Affected populations are always the first responders and always undertake the majority of work in their transitional shelter, reconstruction and recovery, regardless of the way assistance is offered to them. In order to support the priorities, decisions and significant capacities of affected populations; the response should be accountable to them. Representatives from the affected community must be supported to lead or participate fully in planning and coordination activities. In addition to community leaders, groups within communities should be involved, including vulnerable and minority groups, while taking care not to politicise the process.

 **Attention: Consider possible barriers to communication such as language!**



21. The government is ultimately responsible for its citizens and the management of the response, however, different governments have different capacities and each will require different support from humanitarian stakeholders. Many governments have contingency plans and national emergency management authorities in place, and these should be supported where possible. Where it is appropriate or necessary for a humanitarian stakeholder to lead all or part of the coordination, the government should be invited to chair or co-chair coordination meetings. Governments additionally have the right to approve or prevent humanitarian agencies from operating in their country, or in a particular response. The following four broad categories can be distinguished:

- ▶ strong and capable governments who take the lead;
- ▶ capable but under resourced governments who need help to lead;

- ▶ governments who are unable to lead, and need the international community to do this on their behalf for a time; and
- ▶ governments who are unable or unwilling to lead and are obstructive.

Across these four broad categories the international community has to respond differently, but approaches have not always reflected this reality.  DFID, 2011. *Humanitarian Emergency Response Review*.



22. Led by the United Nations, humanitarian stakeholders will agree a single coordination structure. This structure is not a binding agreement however, and humanitarian agencies vary in their attitudes towards coordination, ranging from a strong commitment to consensus and collaborative action to a strong commitment to independent action. At sector level, the coordination structure is responsible for ensuring tools such as Strategic Advisory Groups (SAGs), Technical Working Groups (TwiGs) and Information Management Working Groups (IMWiGs) are established and function effectively » 3.1.5. Under their lead, a strategy will be developed and agreed upon by all stakeholders. This coordination body will assign tasks to implementing agencies according to their skills base and resources.



23. Agencies implementing transitional shelter programmes should commit to developing their programme and project plans in line with the priorities and gaps identified by the overall sector response strategy. Implementing agencies should take an active role in the coordination meetings of the relevant sectors or clusters, sharing assessment, progress, technical knowledge, experience and resources to support the coordinated effort.



**Donors**

24. Bilateral and multilateral donors should be encouraged to attend the coordination meetings of the relevant sectors or clusters, to ensure that they fully understand the needs and priorities of the response.



**Local authorities**

25. Local authorities should be encouraged to attend the coordination meetings of the relevant sectors or clusters, participating fully in policy development and strategic planning, in order to strengthen in-country capacity and existing coordination structures.



**Private sector**

26. Local, regional and international private sector organisations should be involved wherever possible, understanding the constraints to their participating in coordination mechanisms due to profit motives, or as independent actors to provide capacity, expertise, training and supervision during implementation. » 3.6

1

definition

definition of TS  
10 TS principles  
5 characteristics  
when not to use TS  
SWOT

2

tool

decision-making tool

3

programme

coordination  
programme plan  
assessment  
beneficiaries  
labour  
materials  
procurement  
support  
quality assurance

4

site

community  
site selection  
site planning  
land tenure  
handover

5

design

socio-cultural  
minimise risk  
climatic design  
materials  
construction

resources

### 3.1.5 COORDINATION FRAMEWORK

#### What is a coordination framework?

27. A coordination framework is a structure for collaboration that integrates and supports participation using a variety of methods such as committees, meetings, SAGs, TWiGs and IMWiGs. The aim is to facilitate the decision-making process in order to develop, continuously review and implement a strategy and provide opportunities to share information and technical guidance. 📖 [clustercoordination.org](http://clustercoordination.org) [online].

28. The size and composition of a coordination team may vary and additional roles may be required depending upon the nature and scale of the response.

29. Diagram 3.2 below shows the different actors within a coordination framework.

Diagram 3.2  
Coordination  
framework

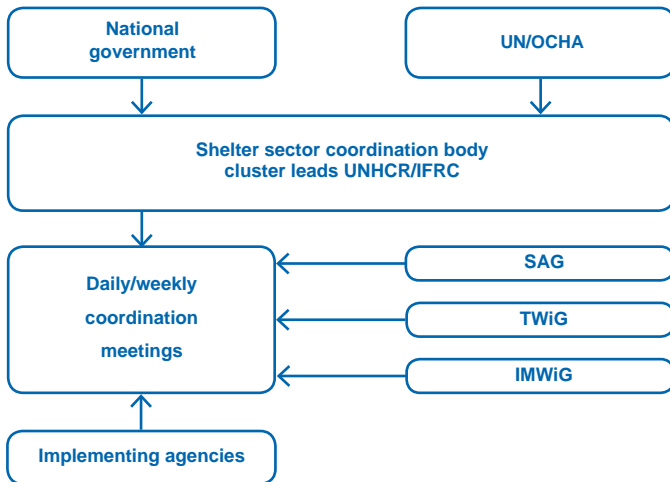

#### Coordination at different levels

30. Typically, between responses, the sector coordination bodies are based regionally while during responses, they are based nationally. Additional hubs are located in the affected areas.

31. Sub-national coordination hubs may use coordination meetings, SAGs, TWiGs and IMWiGs to ensure a more grounded support in the decision-making process and share information at the field operation level, informing the regional, national and global response. Each coordination body should cooperate with their counterparts in the inter-sector coordination bodies, and in the central lead IASC/OCHA coordination bodies.

#### Coordination and transitional shelter

32. Transitional shelter programme and project managers should seek to attend or ensure representation at coordination meetings and activities at levels which are relevant to their

programmes. They should additionally encourage other stakeholders to participate as appropriate. Representation at regional and global levels will be a policy-level decision by each humanitarian agency.

33. Table 3.2 provides three key mechanisms to be used by the cluster coordinator, offering considerations for a transitional shelter programme.

**Table 3.2**  
Coordination mechanisms and considerations

**Table 3.2 Coordination mechanisms**

Coordination mechanism	Considerations for a transitional shelter programme or project manager
<p><b>Strategic Advisory Group (SAG)</b> The role of a SAG is to support the government with the development, implementation and maintenance of a shelter strategy. The SAG is not a decision-making body, but instead the team is typically composed of no more than 10–15 people ideally including representatives from all stakeholders including the government and affected population. » 3.1.4</p>	<ul style="list-style-type: none"> <li>▶ Transitional shelter programmes should be designed and implemented in support of the overall sector and response strategies.</li> <li>▶ Transitional shelter programmes and project managers should ensure that they are represented at SAG meetings and follow agreed SAG outputs.</li> <li>▶ Consider identifying the most relevant SAG members with respect to the nature of work undertaken to ensure views and experiences are shared.</li> </ul>
<p><b>Technical Working Group (TWiG)</b> TWiGs may be formed to offer consultation on technical issues, such as the development of appropriate performance standards, or to agree the minimum hazard resistance required for transitional shelters. In larger responses, the team is typically composed of one or more sector technical advisors, government and appropriate humanitarian representatives. » 3.1.4</p>	<ul style="list-style-type: none"> <li>▶ A transitional shelter TWiG may be formed where transitional shelter has been identified as a part of the overall strategy.</li> <li>▶ Transitional shelter programme and project managers should ensure that they are represented at these meetings and follow the TWiG outputs.</li> <li>▶ Consider identifying and attending other TWiGs relevant to the transitional shelter programme. These may include TWiGs for site selection and physical planning, legal assistance on land tenure and/or compensation schemes, provision of plastic sheeting and non-food items and/or environment.</li> </ul>
<p><b>Information Management Working Group (IMWiG)</b> Information Management Working Groups have two main functions:</p> <ul style="list-style-type: none"> <li>▶ Informing the on-going response through the gathering, collation, analysis and dissemination of reliable and relevant data; and</li> </ul>	<ul style="list-style-type: none"> <li>▶ Coordinate regularly with IMWiGs in order to share collected information, and ensure that assessments do not duplicate information already gathered by other stakeholders.</li> <li>▶ Check whether standard formats and methodologies for information collection have been developed. These should be adhered to in order to improve the compatibility of information collected by various different stakeholders.</li> </ul>

1

definition of TS

10 TS principles

5 characteristics

when not to use TS

SWOT

definition

2

decision-making tool

tool

3

coordination

programme plan

assessment

beneficiaries

labour

materials

procurement

support

quality assurance

programme

4

site

community

site selection

site planning

land tenure

handover

5

design

socio-cultural

minimise risk

climatic design

materials

construction

resources

---

## Coordination mechanism

► communicating with the affected population, offering participation and accountability, and informing the on-going response through developing and maintaining a series of communication routes with representative and marginalised groups.

In larger responses, the team is typically composed of a sector information manager, at least one data manager and GIS manager, supporting government and humanitarian representatives.

» 3.1.4

## Considerations for a transitional shelter programme or project manager

- Coordinate with IMWiGs in order to make use of existing methods of communicating with the affected population.
- Ensure that the IMWiGs and sector coordinators are informed immediately should a significant development occur.

---

 [clustercoordination.org](http://clustercoordination.org) [online].



### Case study: Haiti earthquake internally displaced people, 2010—transitional shelter TWiG

In January 2010 an earthquake of magnitude 7.0 struck Haiti south of the capital Port-au-Prince, resulting in approximately 2.1 million IDPs. During the early response in Haiti, implementing agencies expressed the urgent need to procure longer term shelter items such as timber poles, frames and corrugated galvanised iron (CGI) sheets, in parallel with the emergency shelter and NFIs distribution.

A transitional shelter TWiG was established in February 2010, to agree on minimum standards for transitional shelters suitable for urban and rural settings as well as standards for hazard mitigation. An online library of transitional shelter designs and best practices, compliant with the agreed standards in terms of size, construction process and materials employed, was finalised by the end of July 2010 and widely shared among implementing agencies.  IASC, *Haiti Shelter Cluster* [online].

## 3.1.6 INFORMATION MANAGEMENT

34. Information Management Working Groups have two main functions, as elaborated in »3.1.5:

- ▶ informing the response; and
- ▶ communicating with the affected population, using a communications strategy.

**Informing the response**

35. IMWiGs inform the on-going response through the gathering, collation, analysis and dissemination of reliable and relevant data. The IMWiG collates available government guidance with up-to-date information both supporting and about the humanitarian response. This is to ensure all stakeholders, including those implementing transitional shelter programmes, work with the same instructions throughout planning and implementation. The information is disseminated online, for example through the response sector pages on [www.humanitarianresponse.info](http://www.humanitarianresponse.info), via email, through maps and in meetings.

**Information relevant to sector stakeholders**

36. Sector and transitional shelter stakeholders require such information as:

- ▶ number and location of the communities affected;
- ▶ hazard maps;
- ▶ building damage assessments;
- ▶ land use surveys;
- ▶ strategies, zoning and building codes, standards and cultural norms; and
- ▶ availability of materials, logistics and supply updates.

37. A more complete list, with a focus on information required for transitional shelter projects, is available in the assessment section »3.4.

**Communicating with the affected population**

38. Two-way communication routes are developed with representatives and marginalised groups within the affected population, offering participation and accountability, as well as informing the on-going response. Efforts must be made to engage the community in such reviews to ensure affected populations drive their own planning processes.

**Developing and implementing a communication strategy**

39. A communication strategy may include outreach programmes and public information campaigns. The objectives of the strategy should be agreed by the coordination body. Strategies can be implemented using national and sub-national media such as radio, newspapers and television or other community-based information sharing methods such as committees, workshops and training, suggestion boxes, call centres and short message service (SMS). The distribution of information packs, posters and leaflets are also highly useful tools.

1

definition of TS  
10 TS principles  
5 characteristics  
when not to use TS  
SWOT

definition

2

decision-making tool

tool

3

coordination  
programme plan  
assessment  
beneficiaries  
labour  
materials  
procurement  
support  
quality assurance

programme

4

community  
site selection  
site planning  
land tenure  
handover

site

5

socio-cultural  
minimise risk  
climatic design  
materials  
construction

design

resources



3.1 Communication with the affected population, Pakistan, IOM/Pakistan.

**Information relevant to the affected population**

40. A communication strategy should be developed for disseminating information in local or national languages to both the affected population and host communities. Successful communication with the affected population is integral to ensure that the assistance offered is appropriate, and to limit the possibility of misunderstandings which may lead to false expectations.

41. In terms of transitional shelter, the affected population may require guidance on topics such as:

- ▶ what transitional shelter is;
- ▶ how to participate in planning and implementation of the response;
- ▶ a summary of the approach to transitional shelter in the response and how this impacts reconstruction;
- ▶ how to access transitional shelter assistance;
- ▶ technical assistance on safe transitional shelter construction;
- ▶ related economic opportunities such as in the construction industry;
- ▶ the potential for recycling, reusing, reselling and upgrading transitional shelters;
- ▶ the incorporation of disaster risk reduction measures into permanent reconstruction;
- ▶ the use of grievance redress systems; and
- ▶ how to represent themselves to stakeholders and understand the level of accountability of such stakeholders.

»3.4, »3.8.5



**Importance and sensitivity of information communicated**

42. Information can be extremely sensitive, such as the number of families affected, the level of damage in a particular area, or where the next focus will be for transitional shelter programmes. Firstly, care should be taken not to unintentionally contradict government figures and information; and secondly, not to unintentionally incite civil unrest. The communications strategy should include protocols for engaging with government, as well as a contingency plan in the event of information creating problems within communities, including when inaccurate or incomplete information is disseminated inadvertently.

43. Diagram 3.3 shows possible communication methods to engage the community.

**Diagram 3.3**  
Communication methods



3.2 *Chimen Lakay* newspaper, Haiti, IOM Haiti.

1

definition of TS  
10 TS principles  
5 characteristics  
when not to use TS  
SWOT

definition

2

decision-making tool

tool

3

coordination  
programme plan  
assessment  
beneficiaries  
labour  
materials  
procurement  
support  
quality assurance

programme

4

community  
site selection  
site planning  
land tenure  
handover

site

5

socio-cultural  
minimise risk  
climatic design  
materials  
construction

design

resources



### Case study: Haiti earthquake internally displaced people, 2010—communication methods

In early 2010 an earthquake struck Haiti south of the capital Port-au-Prince. At the end of May 2011 over 630,000 of the initial 2.1 million IDPs were still living in informal settlements and camps, with around 130,000 threatened with forced eviction.

The Tanbou Project was set up by IOM to give the affected population the opportunity to communicate their views by letter, telephone and email. Around 140 suggestion boxes were set up next to information booths, in camps and communities throughout Port-au-Prince. Over 4,000 handwritten letters were received within a year, each catalogued and responded to by IOM.

The letters, calls and emails were then visualised and mapped using specialist initiatives and organisations such as OpenStreetMap Haiti, then stored on a database developed by crowd-sourcing specialist noula.ht. This revealed trends over time in an effort to represent the real needs of the affected population. UNHCR, *Haiti* [online], IOM, *Haiti's Earthquake Survivors Voice Their Hopes And Fears* [online].



3.3 Information kiosk, Haiti IOM Haiti.

44. Maintaining strong coordination mechanisms is key to developing an appropriate, practical and robust programme with stakeholders, which is presented in the next section.

## 3.2.1

## DEVELOPING A PROGRAMME PLAN

## Planning a response

46. Transitional shelter responses should be planned at response, sector, programme and project levels. Each plan should inform the others, in order to achieve a coordinated, consistent and comprehensive response.

## The content and revision of strategies

47. Plans at all levels should maintain a complete record of decisions and agreements including needs analysis, objectives, indicators, sectoral monitoring plans and roles and responsibilities.

48. Continual monitoring and revision of the plans is integral to ensure changing needs are met. With all strategies, it is important to review and revise them on a regular basis, as new information becomes available, and as progress is made.

## Response strategy

49. The response strategy integrates the strategies of each sector into a single common plan, for example ensuring that transitional shelters are supported with water and sanitation. UN/OCHA is the typical lead coordinator of this strategy within the humanitarian community, however, the responsibility ultimately lies with the government which may publish a policy or master plan.

## Sector strategy

50. The sector strategy deals with the shelter needs of the entire affected population and is typically developed by the strategic advisory group of a coordination body, itself supported by a lead agency such as IFRC or UNHCR » 3.1.4. The emergency shelter sector strategy is part of the common humanitarian response linking all other sector strategies such as protection and logistics.

## Programme plan

51. The programme plan deals with the needs of particular groups within the affected population. The transitional shelter response will be defined according to location and specific requirements. The design of the transitional shelter programme will be agreed by all stakeholders. It should be consistent with the sector strategy and integrate a number of project plans.

1

definition of TS  
10 TS principles  
5 characteristics  
when not to use TS  
SWOT

definition

2

decision-making tool

tool

3

coordination  
programme plan  
assessment  
beneficiaries  
labour  
materials  
procurement  
support  
quality assurance

programme

4

community  
site selection  
site planning  
land tenure  
handover

site

5

socio-cultural  
minimise risk  
climatic design  
materials  
construction

design

resources

 **Attention: Coordinate programmes with other organisations**

Make sure to coordinate with other organisations on the content of programmes to avoid beneficiaries comparing offered support in order to find the best “package”.

**Project plan**

52. The project plan deals with the activities within each project for a programme. It is based on agreed standards at the sector level. Each transitional shelter project should be designed as part of the wider shelter programme, using a number of shelter response methods to meet the particular needs of identified beneficiaries.  UN, 2010. *SAD*, p.42–43.

**Programme plan content**

53. Although programmes are designed to respond to specific needs a number of key considerations can be identified. Table 3.3 provides possible template headings.

**Table 3.3 Strategy template**

<b>Table 3.3 Strategy template</b>	
<b>1. Needs analysis</b>	
<b>Assessment</b>	Undertaking continuous assessment, monitoring and evaluation to inform the sector strategy
<b>Options</b>	Deciding which transitional settlement and reconstruction options will be supported and how
<b>Resources</b>	Determining means to obtain the required resources
<b>2. Objectives</b>	
<b>Objectives</b>	Achieving consensus over the desired end state of the response
<b>3. Indicators</b>	
<b>Scenarios</b>	Establishing possible scenarios, from best to worst case, and the likeliness of their occurrence
<b>Opportunities/ challenges</b>	Summarising resolved, existing and predicted opportunities and barriers
<b>Legal</b>	Understanding the existing and relevant legal framework
<b>4. Sectoral monitoring plan</b>	
<b>Schedule</b>	Defining how to overcome the main bottlenecks in implementation, when activities and strategic reviews will take place, and which indicators will be used
<b>5. Roles and responsibilities</b>	
<b>Coordination</b>	Establishing integrated coordination mechanisms, information management and tools
<b>Participation</b>	Agreeing how affected and host populations will be engaged
<b>Handover</b>	A series of handovers occur throughout the response between responsible agencies

Adapted from  UN, 2010. *SAD*, p.44.

**Additional uses of a programme plan**

54. Programme plans should serve the following key purposes:

- ▶ to ensure that the programme and its projects remain in line with the sector strategy;
- ▶ as a tool for conveying needs and appropriate response methods to donors;
- ▶ as a baseline for monitoring project progress and effectiveness, shelter quality, and project assumptions; and
- ▶ as a tool for managing expectations regarding quality and timeliness of delivery.

**Forming a programme plan**

55. Programme plans should be developed in consultation with all stakeholders. Participation and engagement may be difficult to achieve in the first few days following a disaster so initial strategies may need to be based on contingency plans, damage and needs assessments, and preliminary community consultation. Attendance at coordination meetings is important to ensure that initial programme plans are developed in line with sectoral and governmental advice.

**Programme strategy as a live document**

56. A programme plan should be a live document, to be updated and adjusted as more information becomes available. Each draft of the plan should be agreed and disseminated to all stakeholders to ensure that the programme manages expectations and encourages participation whilst remaining relevant to the changing needs of the affected population.



**Tip: Consider national contingency plans**

If suitable contingency plans or national policies exist, they should be used and integrated into the development of the transitional shelter programme strategy.

## 3.2.2 SETTING THE OBJECTIVES

**Objectives**

57. Once the needs of the affected population are understood, a series of programme objectives should be established, covering both short-term emergency needs and those for longer term recovery. Objectives should consider:

- ▶ the needs of the beneficiaries and affected population;
- ▶ overall strategic objectives of the shelter sector;
- ▶ government strategies and policies;
- ▶ donor requirements; and
- ▶ agency or organisation mandates.

**Consulting all stakeholders**

58. Effort should be made to ensure all stakeholders are involved and kept up to date on objectives as they evolve throughout the process. A system of analysis, consultation and feedback is essential to ensure inclusion of all bodies.

1

definition of TS  
10 TS principles  
5 characteristics  
when not to use TS  
SWOT

definition

2

decision-making tool

tool

3

coordination  
programme plan  
assessment  
beneficiaries  
labour  
materials  
procurement  
support  
quality assurance

programme

4

community  
site selection  
site planning  
land tenure  
handover

site

5

socio-cultural  
minimise risk  
climatic design  
materials  
construction

design

resources

- Agreement at all levels** 59. The continuous process of consultation, feedback and drafting should reflect the consensus achieved at all levels (sector, programme and project). 📖 UN, 2010. *SAD*, p.34–35.
- Transition to what?** 60. In most responses, the international humanitarian and development communities will not have sufficient resources to support the repair or full reconstruction of every damaged building. In these circumstances, careful consideration must be given to the role of transitional shelter in supporting affected populations in the later reconstruction of their own home. A well planned exit strategy needs to be included to ensure continuous support of beneficiaries » 3.2.4.

### 3.2.3 PROGRAMME AND PROJECT MANAGEMENT

- Programme management** 61. Successful programme and project management is not just about achieving a set of goals, but is a combination of planning, organisation and implementation through the direction and supervision of staff and activities. Management is an expansive topic that includes diverse concerns including those mentioned elsewhere in this guidance. This sub-section addresses some key areas relating to the internal capacity of an organisation when carrying out a transitional shelter programme.
- Organisational structure** 62. Good management starts with the recognition that any organisation is only as effective as the people and procedures within it. All organisations are made up of interrelated parts, and if any one part performs poorly it will affect the performance of the whole system. An organisation's effectiveness is based on its capacity to organise and establish staff, systems and finances to translate programme objectives into specific activities.
- Internal capacity** 63. There has been an increasing realisation that poor performance may be linked to internal organisational problems which has led to increased attention on assessing organisational capacity. 📖 INTRAC, 1995. *Participatory Self Assessment on NGO Capacity*, p.1. The size of a programme is not an indicator of positive impact – one of the key lessons after the 2004 Asian Tsunami was that each organisation must operate within its technical and financial capacities.
- NGO self-assessment** 64. While there is a range of formal methods for assessing internal organisational capacity, in an emergency context, project reports showing previous lessons learned and a rapid self-assessment can highlight key trends. These assessments require little time, but can play an important role in gaining an insight into the organisations strengths and weaknesses and where problems are likely to occur. This should inform the planning of programmes. 📖 UNDP, 2005. *Brief Review of 20 Tools to Assess Capacity*.

## SWOT analysis

65. One tool that can be used to assess the internal capacities of an organisation is the SWOT (strengths, weaknesses, opportunities and threats) tool. This can rapidly identify strengths and weaknesses and highlight where additional support or effort must be made to ensure a programme runs smoothly. It may also identify problem areas which may affect the implementation of the project which are not easily resolvable. 📖 ODI. *SWOT Analysis*.

## Human resources management

66. Often emergency response programmes require an acute increase in staffing levels. Accurate estimation of personnel requirements can be difficult in the early stages when information is limited or incomplete. Self-assessment and planning tools can aid in estimating initial requirements which can be adjusted as more information becomes available. >>3.2.4

## Demand and availability

67. Identification of the availability of suitably qualified staff can impact programming decisions. It is important to assess both the existing skills in an organisation as well as the available skills in the population when choosing a programme design. As demand peaks there is often high competition for local staff with appropriate skills and experience. Agencies can often face difficulties recruiting staff due to the lack of local expertise, the time required to identify and recruit international staff and competition between agencies. 📖 DEC, 2010. *Lessons from Aceh*, p.75.

## International staff

68. International recruitment may be appropriate in the early stages to supplement local staff and provide expertise or technical support and training. Many agencies keep a roster of qualified or experienced staff to call upon in the early stages of a response. High turnover of staff can make continuity and accountability difficult, and can put stress on longer term staff. Positions with high turnover rates should be well defined to ensure that the position is well-understood by incoming staff. Strong information management is essential, and where possible a handover period between incoming and outgoing staff should exist.

## National staff

69. National staff usually make up the majority of agency employees. Some may be long-term employees in a country office while others may have to be recruited for particular projects. National staff are important resources, not only in the skills they bring, but in their knowledge and understanding of the local context and cultural traditions. A selection of national/local staff may increase and replace international staff over time.

1

definition of TS  
10 TS principles  
5 characteristics  
when not to use TS  
SWOT

definition

2

decision-making tool

tool

3

coordination  
programme plan  
assessment  
beneficiaries  
labour  
materials  
procurement  
support  
quality assurance

programme

4

community  
site selection  
site planning  
land tenure  
handover

site

5

socio-cultural  
minimise risk  
climatic design  
materials  
construction

design

resources



## Recruitment mechanisms

70. When considering human resources (HR) capacity, it is important to think not only of people, but the recruitment process. A fair and transparent recruitment process is important for attracting good staff. After a disaster HR departments are often inundated with requests from all sectors within an organisation. It is important to know the procedures that must be adhered to and have a realistic expectation of how long it will take to move through them. It is also vital to ensure that new team members are given full orientation and induction to the job.

For more information on human resource management see  Practical Action, 2008. *Managing Humanitarian Relief*, Chapter 8.

## Logistics



### Impact of logistical capacity

71. Logistics involves the acquisition, control, handling, transport, storage and delivery of goods and supplies. Challenges in logistics in an emergency context normally arise as a result of the urgency and inherent restraints after a disaster. However, poor logistics will inevitably result in programmes being unable to carry out their work efficiently.

### Early engagement and planning

72. Logistics and procurement mechanisms are dealt with more fully in »3.7, however, it is useful to plan with logistics specialists in order to identify potential barriers or problems at the outset or the need for additional technical staff.

### Response vs programme level

73. The logistics cluster is responsible for producing a LCA (logistics capacity assessment) for an emergency, which specifies country level impediments to supply chains.  Logistics cluster, *Homepage* [online]. However, it is also important every organisation assesses their own internal logistical capacity. Shelter and permanent reconstruction require significantly greater logistical capacity than other sectors of humanitarian operations as the supply of multiple materials from multiple sources needs to be coordinated.  DEC, 2010. *Lessons from Aceh*, p.81.

### Technical expertise

74. After the Asian Tsunami in 2004, some agencies found they did not have the technical expertise to correctly specify structural grade or durable timber and resorted to using poor quality materials from unsustainable sources. For NGOs who are new to a country or lack experience in undertaking shelter construction, this often a key constraint.  DEC, 2010. *Lessons from Aceh*, p.37.

## Partner organisations

### Benefits of local partners

75. While local NGOs do not usually have the logistical capacity or the reach of larger organisations, they bring other advantages such as an understanding of the local context, experience working directly with local marginalised communities and continued presence in the community »3.5.

**Identification of local partners**

76. Many agencies already have pre-existing relationships with local partners, which form the basis for emergency response. Where this is not the case, rapid identification of credible local implementing partners to assist in a programme can be a difficult task. Identification of local groups, community-based organisations (CBOs) or local NGOs should form part of initial assessments.

**Clarity of involvement**

77. Local partners may be new to working with humanitarian agencies or on a transitional shelter project. Clear and regular communication with implementing partners is vital to ensure that both sides understand each other. Before partnering with an organisation is it also important to analyse their skills and capacity and what support may be required.

**Adequate support for partners**

78. It is necessary to ensure that local partners have appropriate tools, materials, knowledge and skills prior to commencing work. Capacity building and training sessions for local partners may be appropriate and should be included in the budget and staffing requirements.

**Working in partnership**

79. In any partnership it is important for both parties to be clear on the aims and objectives of the partnership and the terms on which it will work. In particular, tensions can run high if local partners feel over-burdened, disregarded or that there is a lack of support.

For more information on working with local partners see  Practical Action, 2008. *Managing Humanitarian Relief*, Chapter 15

**Funding**

**Risk of donor-driven funding**

80. As all NGOs are reliant on donor funding, there is always a risk of donor-driven rather than demand-driven responses. NGOs are situated as intermediaries in a chain which transfers resources and so must acknowledge and respond to both sides. Maintaining good relations with donors is important but need not force NGOs to neglect demand-driven responses as good research will almost always justify a particular project type and approach.

**Balance of capacity, needs and funds**

81. There must be a balance when searching for funding between the organisation's capacity and the needs of the affected population. Sometimes pressure to raise funds after a disaster can negatively affect good judgement on the capacity to use the funds wisely. Agencies must resist the temptation of accepting funding that is beyond their experiential or logistical capacity to spend well.  Roper, L., et al., 2006. *Tsunami Learning Project*, p.19.

82. It is important that if applying for funding for a transitional shelter approach that the concept is well understood by the donor. Decisions over whether to embark on a transitional

1

definition of TS  
10 TS principles  
5 characteristics  
when not to use TS

definition

2

decision-making tool

tool

3

coordination  
programme plan  
assessment  
beneficiaries  
labour  
materials  
procurement  
support

programme

4

community  
site selection  
site planning  
land tenure  
handover

site

5

socio-cultural  
minimise risk  
climatic design  
materials  
construction

design

resources

shelter programme will be influenced by the amount of funding available and the organisation's capacity to access it, alongside technical considerations. Different donors may fund different stages of a response which can be targeted to provide continued support. Forward planning is essential to ensure that support can be provided until a durable solution is found.

### Accounting and budgeting

#### Accounting

83. Most organisations have pre-existing accounting policies and procedures in place to ensure transparency when buying and receiving budgeted items. Whether accounts are handled directly or managed by another department will depend on the size and complexity of the organisation. During a response these processes can often put pressure on the timely acquisition of items, therefore good communication between departments and clear knowledge of the amount of time required for processing is necessary.

#### Budgeting

84. A budget specifies the amount of money needed to complete a project over a specified timeframe, how much money will be available from all sources and when, and how, it will be spent. 📖 Save the Children, 2005. *Programme Management Best Practices*, p.15. Budgeting should be carried out concurrently with programme design and take into account both direct and indirect costs.

#### Support in tracking expenditure

85. Project managers should closely track expenditure and compare with the budget. Financial tracking in a large scale project over a wide geographical area can be difficult. Breaking areas down into manageable sizes and keeping good records make this easier. In addition, financial training should be given to project managers to familiarise themselves with the process.

#### Building contingency into budget

86. It is important to have a clear and realistic idea of how much money will be required and when. However, inflation, changing exchange rates and fluctuating materials costs can make accurate cost estimates difficult. Budgeting should take into account contingency planning to allow for fluctuation in exchange rates or inflation in goods and services. Close relations should be kept with donors in case of funding needing to be renegotiated or re-allocated.

## 3.2.4 PLANNING TOOLS

#### What are planning tools?

87. Planning tools can be used to inform and assist the development of sector, programme and project plans. Various types of tools, such as a logical framework approach (LFA) and Gantt charts, can be used to support the planning of a transitional shelter response.

## Logical framework approach

What is a logical framework approach?

88. A LFA provides a structure for describing and communicating a project or programme as a causally linked series of components: activities, outputs, objectives and goals. These components should form a logical sequence such that activities can be seen to contribute to the overall goal. Measurable indicators, means of verification and assumptions are identified at each stage.

Use of a logical framework approach

89. A LFA can be used by programme managers as a tool to analyse and communicate the logic of the planned activities and how they will contribute to the transitional shelter programme. A LFA template is shown in the Table 3.4 below.

Table 3.4 Logical framework approach template

Table 3.4 Logical framework approach template

Hierarchy of objectives	Performance indicators	Means of verification for monitoring and coordination	Assumptions and risks
<b>GOAL:</b> a statement of the overall goal the operation/ project is to achieve	Quantitative ways of measuring or qualitative ways of judging progress towards or achievement of the overall goal	Description of the means for gathering data on, and assessing performance against, indicators	External factors, conditions or events, which are necessary in order for the goal to be met
<b>OBJECTIVE:</b> a statement of the specific objective in terms of change or benefits of the project	Quantitative ways of measuring or qualitative ways of judging progress towards or achievement of the objective	Description of the means for gathering data on, and assessing performance against, indicators	External factors, conditions or events, which are necessary for the objective to be met
<b>OUTPUTS:</b> the specific deliverables/ results expected from the project	Quantitative ways of measuring or qualitative ways of judging progress towards or achievement of the outputs	Description of the means for gathering data on, and assessing performance against, indicators	External factors, conditions or events, which are necessary for the outputs to be achieved
<b>ACTIVITIES:</b> the activities that must be carried out in order to produce the outputs	A description of the input resources required to produce the outputs	A description of cash flow requirements over the duration of the project	External factors, conditions or events, which are necessary for the activities to be performed

UN, 2010. *SAD*, p.193.

Monitoring and evaluation

90. The identification of indicators for the programme goal, objectives and outputs also provides a useful tool for monitoring and evaluation.

1

definition of TS  
10 TS principles  
5 characteristics  
when not to use TS  
SWOT

definition

2

decision-making tool

tool

3

coordination  
programme plan  
assessment  
beneficiaries  
labour  
materials  
procurement  
support  
quality assurance

programme

4

community  
site selection  
site planning  
land tenure  
handover

site

5

socio-cultural  
minimise risk  
climatic design  
materials  
construction

design

resources

## Critical path analysis

### Critical path analysis

91. Critical path analysis (CPA) such as a Gantt chart, identifies which activities must be completed as scheduled to ensure that a project or programme is completed on time, and which activities may be delayed if it becomes necessary to re-allocate resources.

92. CPA and the duration of each activity required to complete a programme should be defined. The dependencies between activities should be assessed. Inter-activity dependencies include cases where one activity cannot be undertaken until previous activities have been completed, and activities which can be undertaken simultaneously.

93. This information can be used to calculate the minimum possible length of a programme, and the earliest and latest possible start and end times for each activity which will not affect the proposed completion date.

### Use of a Gantt chart

94. A Gantt chart can be used by programme managers to identify planning indicators which can enable the early identification of scenarios affecting the schedule of operations. A Gantt chart can also be used to pre-plan appropriate schedules of operations for a number of possible scenarios. If the situation changes, rendering the original schedule of operations inappropriate, a more suitable response can be implemented quickly. An example of a Gantt chart is shown in Table 3.5.

**Table 3.5**  
Gantt chart  
example

Table 3.5 Gantt chart example				
Planning process	04	05	06	07
Preparing to plan	◐			
Get commitment	■			
Outline plan process	■			
Form planning team	■			
Initial planning meeting	◐			
Documentation ready	■			
Determine deadlines	■			
Field mission planned		■		
Planning scenario set		■		
Situation assessment		■		
Field missions		■		
Draft plans			■	
Follow-up meeting			◐	
Agree operations design			■	
Develop projects				■
Develop budgets				■
Procurement				■
Coordination plan set				■
Finalised plan				◐

UN, 2010. SAD, p.194.

## 3.2.5 EXIT STRATEGY

### Exit strategy

95. The process of moving from emergency to rehabilitation and development can be referred to as the exit strategy. It involves a change in role of the implementing agencies and organisations as well as their respective staff within the government structure.

96. Exit strategies should be designed from the inception of the programme and project and readdressed as situations change and the response evolves.  IASC, 2007. *Exit Strategy For Humanitarian Actors In The Context Of Complex Emergencies*, p.1.

### Financial considerations

97. In many cases, as projects come to an end, resources and financial means are limited. Therefore, it is crucial that the exit strategy is incorporated in the budget from the outset. Key issues for consideration include:

- ▶ adequate resources to ensure an appropriate handover;
- ▶ financial means for successful demobilisation;
- ▶ communication and messaging;
- ▶ guaranteed funding for payments; and
- ▶ defects liability periods in contracts.

### Appropriate timing

98. Implementation of an exit strategy too early in the process may result in continuation of conflict, insecure future conditions and/or the risk of entertaining political objectives. Similar consequences may also occur if the exit strategy is implemented too late. If the beneficiaries become dependent upon humanitarian assistance, expectations may exceed government capacities.

99. In order to determine the appropriate time for implementation of an exit strategy, an inter-agency forum under the leadership of the coordinating structure should undertake extensive evaluation of the situation. Key issues for consideration include:

- ▶ significant reduction in the size of the affected population;
- ▶ success of negotiations within conflict areas;
- ▶ return to social, political and economic norms;
- ▶ government capacity to achieve and maintain objectives; and
- ▶ implementation of a resource mobilisation strategy.

 IASC, 2007. *Exit Strategy For Humanitarian Actors In The Context Of Complex Emergencies*, p.2.

1

definition of TS

10 TS principles

5 characteristics

when not to use TS

SWOT

2

decision-making tool

3

coordination

programme plan

assessment

beneficiaries

labour

materials

procurement

support

quality assurance

4

community

site selection

site planning

land tenure

handover

5

socio-cultural

minimise risk

climatic design

materials

construction

definition

tool

programme

site

design

resources

**Responsible  
exit**

100. Various planning tools such as those previously mentioned can be used to review the exit strategy timing on a continuous basis. To ensure a responsible exit, appropriate handover procedures should be implemented »4.5. The intention should be to ensure a smooth departure of implementing agencies handing over to local government and/or local NGOs or CBOs in a transparent manner. All stakeholders, agencies and the affected population should be included in the process and updated at regular intervals.

101. The following section provides a basic introduction to the implementation and maintenance of a programme strategy. It provides information on the importance of coordination between strategic planning levels as well as maintaining the strategy as a live document able to reflect the ever changing requirements of the affected population.



### 3.3

## PROGRAMME ASSESSMENT

#### The aim of assessment

102. Each agency will have its own format and standard operating procedures for assessment: this guidance is intended to ensure they are consistent, in support of broader shelter sector and response level assessments. Assessment must be undertaken first to determine whether or not transitional shelter may be an appropriate response. If a transitional shelter approach is to be implemented, further assessment must be undertaken to ensure the specific design of the shelter is appropriate, and the assistance methods to be used. Subsequently, monitoring and evaluation procedures should be used to determine whether changing circumstances require a review of the assessment, to inform the revision of strategies and plans.



#### **Attention: Assess self-help capacity**

Make sure that the self-help capacity of the affected population is assessed correctly. Wrong assumptions about the inherent capacity of a community to self build and the willingness of individuals to share their skills may lead to vulnerable families being the last to be assisted e.g. female/child/elderly headed households.

For more details on assessment in emergencies including sample assessment forms, please refer to UN, 2010. *SAD*, UNHCR, 2007. *Handbook For Emergencies*, The Sphere Project, 2011. *The Sphere Handbook*, ICRC/IFRC, 2008. *Guidelines For Assessment In Emergencies*.

### 3.3.1

## STAGES OF ASSESSMENT

#### Stages of assessment

103. Assessment should start during or immediately following a disaster and continue throughout a response. Regular assessment is vital to ensure that project, programme and sector strategies can be adapted to changing circumstances and remain relevant to the changing needs of the affected population.

104. The assessment process is commonly structured in four stages: preliminary, rapid, joint and monitoring and evaluation. These stages are shown in Diagram 3.4 on the following page.

1

definition of TS

10 TS principles

5 characteristics

when not to use TS

SWOT

2

decision-making tool

3

coordination

programme plan

assessment

beneficiaries

labour

materials

procurement

support

quality assurance

4

community

site selection

site planning

land tenure

handover

5

socio-cultural

minimise risk

climatic design

materials

construction

definition

tool

programme

site

design

resources

**Diagram 3.4**  
The four stages  
of assessment  
after a disaster

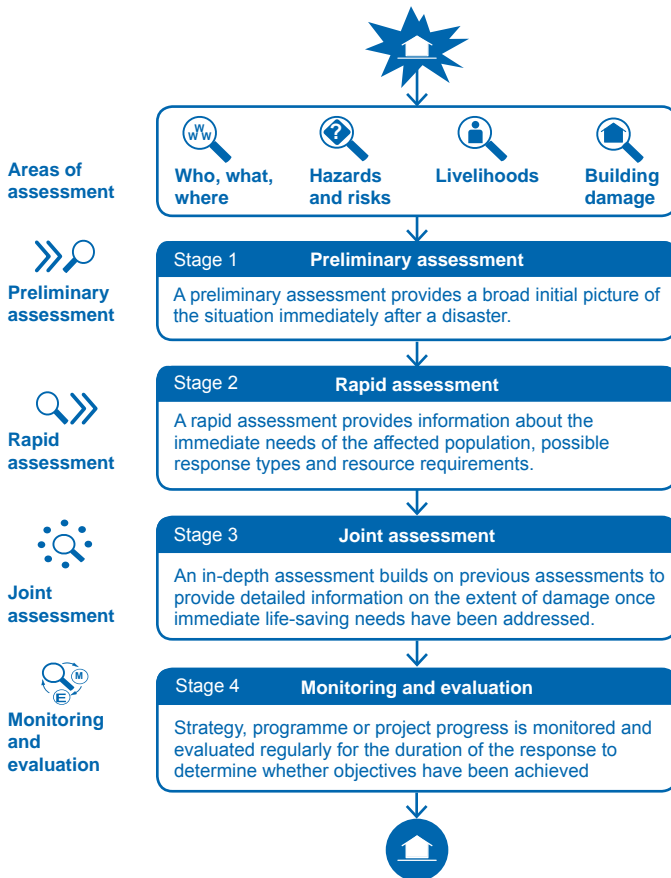

UN, 2010. *SAD*, p.67.

### Preliminary assessment

105. A preliminary assessment provides a broad initial picture of the situation to serve as a basis for deciding on the type and amount of support agencies may offer.

106. Preliminary assessments are undertaken in the first 24–72 hours following a disaster or crisis. Information may be gathered through coordination meetings, interviews, observation and published information such as news reports, satellite imagery, census information and accounts from search and rescue teams.

### Rapid assessment

107. A rapid assessment provides information on the immediate needs of the affected population, the extent of the damage, possible response types and resource requirements and availability.

## Joint/detailed assessment

108. Joint assessments build on previous assessments to provide further, in-depth information on the extent of damage once immediate life-saving needs have been addressed.

109. Joint assessments are usually conducted within a few days to a few weeks following a disaster. They should ideally be formally coordinated between agencies or sectors to enable efficient usage of resources and sharing of information.

## Monitoring and evaluation

110. Monitoring and evaluation is a systematic and continuous activity. Results and findings are used to refine and update sector, programme and project strategies according to changing scenarios and regular feedback from the beneficiaries, and to assess progress towards defined objectives. >> 3.9



### Tip: Sharing the results from surveys and assessments

Before carrying out an assessment, check that such assessments have not been previously undertaken, and share the surveys with the information manager (e.g. land use surveys, damage assessments, hazard and risk mapping etc.). However, close attention should be paid to the sensitivity of shared personal beneficiary data.

### Importance of participation in assessment

111. The participation of the affected population in assessments is essential to ensure that accurate information about the physical and social conditions of the affected population is attained, and that local construction methods and materials are fully understood.

112. Further information on participation in assessment, including the UNHCR *Tool for Participatory Assessment in Operations* is available in UNHCR, 2006. *The UNHCR Tool For Participatory Assessment In Operations*.

## 3.3.2 WHO, WHAT, WHERE?

### Who, what, where assessment

113. The mapping of damage, needs and hazards allows stakeholders to understand the scale of the disaster, and how best to address the immediate, and predict the long-term shelter capacities and needs of the population.

### Area selection

114. It is vital to assess the presence of other agencies or organisations active in the particular area in order to coordinate support and to make sure, that activities are evenly spread across the affected area.

### Factors to be assessed

115. The following information may be required when considering the implementation of a transitional shelter response.

1

definition of TS  
10 TS principles  
5 characteristics  
when not to use TS  
SWOT

definition

2

decision-making tool

tool

3

coordination  
programme plan  
assessment  
beneficiaries  
labour  
materials  
procurement  
support  
quality assurance

programme

4

community  
site selection  
site planning  
land tenure  
handover

site

5

socio-cultural  
minimise risk  
climatic design  
materials  
construction

design

resources

- ▶ numbers and locations of the affected population (e.g. the estimated percentage displaced and non-displaced);
- ▶ which option for settlement and reconstruction has been selected and by whom within the affected population? Would transitional shelter complement or assist these choices?;
- ▶ self-help capacity of the affected population;
- ▶ the property and land rights of the affected population prior to the conflict or disaster; and
- ▶ availability of land for displaced populations.

116. The “who, what, where” factors should be continually monitored and reviewed, as displaced and non-displaced populations may move between transitional settlement and reconstruction options over time, requiring the selected transitional settlement and reconstruction responses to be adapted to remain relevant to the affected population.

#### Geopolitical

117. The understanding of geopolitical, social and cultural issues allows stakeholders to be aware of different behavioural patterns happening after disaster. Understanding the different geographical variables, such as climate, topography, demography and available natural resources allows stakeholders to analyse and forecast the impacts of political power decisions over a certain territory.

#### Social and cultural context

118. An understanding of the social and cultural context informs the technical decision-making process. This understanding may avoid decisions that may compromise social and cultural behaviour. It is possible that there will be post-disaster behavioural changes and as a result these changes should be noted and analysed. They may have further impact on the decision-making process.

### 3.3.3 IDENTIFYING HAZARDS AND RISKS

#### Hazards and risk assessment

119. The primary responsibility of any humanitarian intervention is the safety of the affected population. Hazard and risk assessments provide information on the initial cause of damage, and the potential for additional damage caused by future disturbances. Populations may be at risk from a number of hazards at the same time, for example earthquakes may cause tsunamis or fires. Primary and secondary sources of vulnerability should be identified, including exposure to natural and man-made hazards, extreme climatic conditions, and environmental and health issues.

120. Hazard and risk assessments should inform disaster risk reduction (DRR) strategies in the site selection and preparation process and in shelter design and construction. » 5.2

**Factors to be assessed**

121. The following hazard and risk factors may be assessed when considering the implementation of transitional shelter programmes.

- ▶ hazards for which DRR techniques should be included in the shelter design to ensure the safety of inhabitants;
- ▶ hazards for which DRR techniques may be included in shelter design to encourage dissemination into permanent reconstruction (including long-term hazards which may represent only minimal short-term risks);
- ▶ hazards which may require immediate evacuation or permanent relocation; and
- ▶ hazards which will impact site selection and preparation.

**Hazard mapping**

122. Preliminary hazard mapping such as topographic models, photographic maps and satellite imagery may be used when selecting sites for temporary shelter and permanent reconstruction. >>4.3.2

123. Multi-hazard maps may be used to communicate the dangers of settling in specific locations to the affected population. Maps should be presented in a way that is clear for the affected population to understand.

### 3.3.4 **BUILDING DAMAGE**

**Damage assessment**

124. Damage assessments inform reconstruction but also transitional shelter. Damage assessments involve surveys and inspections of housing, public buildings and infrastructure, and have to be carried out by experts with specific technical knowledge such as structural engineers.

125. Damage assessment can be used to identify the type and extent of damage to buildings and infrastructure, identify causes of structural failure, and identify construction methods and techniques which may be used to ensure that repair and reconstruction is sufficiently hazard resilient.

**Factors to be assessed**

126. The following factors may be assessed when considering the implementation of a transitional shelter programme:

- ▶ hazards from damaged buildings;
- ▶ identification of construction materials which may be salvaged from damaged or destroyed buildings for use in transitional shelter;
- ▶ traditional building techniques which should be integrated into a transitional shelter programme;
- ▶ traditional building materials which should be prioritised in transitional shelter design;
- ▶ causes of failure in buildings, to ensure that DRR techniques can be integrated into transitional shelter and reconstruction; and

1

definition of TS  
10 TS principles  
5 characteristics  
when not to use TS  
SWOT

definition

2

decision-making tool

tool

3

coordination  
programme plan  
assessment  
beneficiaries  
labour  
materials  
procurement  
support  
quality assurance

programme

4

community  
site selection  
site planning  
land tenure  
handover

site

5

socio-cultural  
minimise risk  
climatic design  
materials  
construction

design

resources

- ▶ assessment of the length of time that may be needed for reconstruction and how best transitional shelter may support this process, which is important also for ascertaining how long transitional shelter may need to last.



3.4 Building damage, Pakistan 📷 Marco Botelli/IOM Pakistan.

### 3.3.5

## IMPACT ON LIVELIHOODS AND MARKET ASSESSMENT

127. The assessment of livelihoods may inform the development of transitional shelter designs by determining what capacities or capitals the affected population may draw upon, and where these capacities or capitals may be supported by transitional shelter programmes. Programmes should support affected communities by improving their living conditions in order to support them in regaining sustainable livelihoods, on their paths to recovery.

#### Livelihoods capitals

128. When considering the functions of a transitional shelter programme, the following five livelihoods capitals should be considered: financial, physical, human, social and natural.

#### Financial capital

129. Financial capital recognises income means before and after the conflict or disaster. The following issues should be considered:

- ▶ required financial assistance for beneficiaries in order to be able to relocate, recycle, reuse, resell or upgrade their shelters;
- ▶ financial savings of the beneficiaries;
- ▶ insurances held by beneficiaries; and
- ▶ availability of financial support for beneficiaries.

#### Physical capital

130. Assessing physical capital means evaluating the state of the surrounding built environment and infrastructure. Important factors are:

	<ul style="list-style-type: none"> <li>▶ level of damage to and availability of infrastructure, including water and sanitation, energy and communications facilities; and</li> <li>▶ availability of relevant technologies.</li> </ul>	<p>1</p> <p>definition of TS</p> <p>10 TS principles</p> <p>5 characteristics</p> <p>when not to use TS</p> <p>SWOT</p>	<p>definition</p>
<p><b>Human capital</b></p>	<p>131. Human capital consists of the available knowledge, skills and health of the population. These may include:</p> <ul style="list-style-type: none"> <li>▶ construction and management skills contributing to both, the initial shelter construction, as well as to relocating, recycling, reusing, reselling and upgrading shelters and shelter components; and</li> <li>▶ knowledge of languages which facilitates communication between displaced and host populations.</li> </ul>	<p>2</p> <p>decision-making tool</p>	<p>tool</p>
<p><b>Social capital</b></p>	<p>132. Social capital involves community trust, rules and networks that people can draw upon to work together. The following factors should be assessed:</p> <ul style="list-style-type: none"> <li>▶ existing mechanisms for decision-making;</li> <li>▶ cultural and official networks and support methods;</li> <li>▶ local leadership; and</li> <li>▶ existence and strength of markets for obtaining materials.</li> </ul>	<p>3</p> <p>coordination</p> <p>programme plan</p> <p>assessment</p> <p>beneficiaries</p> <p>labour</p> <p>materials</p> <p>procurement</p> <p>support</p> <p>quality assurance</p>	<p>programme</p>
<p><b>Natural capital</b></p>	<p>133. Natural capital refers to the condition of the local ecosystem, available resources, opportunities and constraints. Factors to be assessed:</p> <ul style="list-style-type: none"> <li>▶ availability of material, land, food and water resources throughout the programme;</li> <li>▶ potential for agriculture and animal husbandry;</li> <li>▶ amount of fuel and energy resources available as well as their rate of accessibility; and</li> <li>▶ short-term and long-term environmental impact.</li> </ul>	<p>4</p> <p>community</p> <p>site selection</p> <p>site planning</p> <p>land tenure</p> <p>handover</p>	<p>site</p>
	<p>134. The availability of appropriate construction skills and labour within the affected population, and within implementing partners, should be assessed. This information can be used to ascertain what shelter design and construction techniques may be appropriate, and what training and capacity building may be required:</p> <ul style="list-style-type: none"> <li>▶ information gathered from capacity assessments may help to determine the most appropriate combination of assistance methods (labour, materials, support and quality assurance methods);</li> <li>▶ environmental assessments should identify the extent of environmental damage, whether due to natural disaster or conflict, and potential challenges and/or opportunities for improvement during the response;</li> <li>▶ availability of and access to natural resources should be assessed. For transitional shelter programmes, this may include materials such as timber or cladding, and</li> </ul>	<p>5</p> <p>socio-cultural</p> <p>minimise risk</p> <p>climatic design</p> <p>materials</p> <p>construction</p>	<p>design</p> <p>resources</p>



sand and aggregates from riverbeds. Results from these assessments will affect the shelter design and selection of building materials; and

- ▶ the availability of materials and tools in local, national and international markets should be assessed. Where possible, transitional shelter programmes should support local markets by procuring materials locally.

Further information on undertaking environmental assessments, including assessment tools, can be found in

📖 The World Bank, 2010. *Safer Homes, Stronger Communities*.

#### Market assessment

135. Tools such as the emergency market mapping and analysis (EMMA) may be used to gather information about the conditions of local markets and access to resources. The tool can also be used to help establish a rapid and efficient procurement process for shelter programmes. EMMA can be used to identify opportunities for rehabilitating markets which can be vital to ensure continued access to items for transitional shelter projects.

More information on the emergency market mapping and analysis tool can be found in 📖 Oxfam, 2010. *Emergency Market Mapping and Analysis (EMMA) Toolkit*.

## 3.4

# BENEFICIARY IDENTIFICATION

136. This section gives information regarding the beneficiary identification process, covering the three main steps, starting with the selection criteria agreement. It then goes on to describe the beneficiary selection procedure, the final balance between the number of selected beneficiaries and the level of assistance. This will then inform and support the decision-making process regarding the choice of support methods.

### 3.4.1

## AGREEING CRITERIA FOR IDENTIFYING BENEFICIARIES

137. Each agency will have its own format and standard operating procedures for identifying beneficiaries: this guidance is intended to support these to be consistent, in order to promote broader shelter sector and response level beneficiary identification.



3.5 Beneficiary selection assessment interview, Haiti 📷 Cordaid Haiti.

#### Purpose of beneficiary identification

138. The purpose of beneficiary identification is to determine who within the affected population should receive what assistance, by understanding:

- ▶ who has been impacted, to determine the scale of response;
- ▶ how they have been impacted, to determine the priorities of response;
- ▶ their needs and vulnerability, to determine the nature of response; and
- ▶ their legal rights, such as land tenure, to determine how they may be assisted.

1

definition of TS  
10 TS principles  
5 characteristics

definition

when not to use TS  
SWOT

2

decision-making tool

tool

3

coordination  
programme plan  
assessment  
beneficiaries

programme

labour  
materials  
procurement  
support  
quality assurance

4

community  
site selection  
site planning  
land tenure  
handover

site

5

socio-cultural  
minimise risk  
climatic design  
materials  
construction

design

resources

139. When establishing a beneficiary identification process for transitional shelter programmes, care should be taken to consider the individual circumstances of the affected population, as there is no “one size fits all” approach. In order to establish selection criteria a range of eligibility issues considering the different groups of the affected population and levels of damage must be recognised.

**Role of government**

140. The local government should develop the assistance strategy and entitlement policies on the basis of national disaster laws; however, a selection committee should be established to allow broader stakeholder consultation, including representatives of the affected communities to identify the most vulnerable households.

**Role of the shelter sector**

141. The following points are to be considered:

- ▶ existing government policies regarding post-disaster housing assistance; and
- ▶ ensure that agencies collaborate on selection criteria, in order to avoid conflict.

142. Existing data which could be used to inform the qualification and beneficiary process, such as families who have received assistance in the past in the form of low interest loans or assistance in any down payments, should be checked.



**Case study: Haiti earthquake 2010—IOM transitional shelter programme**

For its transitional shelter programme in Haiti, IOM worked in coordination with local communities and in close cooperation with local government representatives and considered the following eligibility criteria:

- ▶ the level of damage to the original house;
- ▶ the current temporary living situation (e.g. with host family or in an IDP site); and
- ▶ priority to vulnerable IDP families (disabled persons, elderly, single-headed households etc.).

 IOM, 2010. *IOM Haiti*.

**Considerations for displaced beneficiaries**

143. For the dispersed transitional settlement options, such as urban self-settlement:

- ▶ beneficiaries may be indistinguishable from the host population or even from combatants; and
- ▶ self-settlers may have different rights from existing informal settlers without legal status.

**Considerations for non-displaced beneficiaries**

144. In responding to transitional reconstruction, the rights of beneficiaries must be identified before assistance is given. In numerous circumstances, tenants and occupants with no legal status:

- ▶ are omitted from beneficiary lists;
- ▶ are included as beneficiaries in transitional settlement but not transitional reconstruction; and
- ▶ are often the most vulnerable and least able to return to sustainable livelihoods.

145. A good transitional shelter programme with suitable project planning should fulfil the primary objective of involving the affected population during the consultation, planning and implementation process.

### 3.4.2 BENEFICIARY SELECTION

146. Regarding the beneficiary selection process, the following actions should be incorporated.

**1st action**

147. Beneficiaries are identified through a selection committee consisting of representatives from stakeholders including the affected community and local government.

 **Attention: Monitor selection committees in order to avoid that mainly friends or supporters are selected**

**2nd action**

148. Local governments and humanitarian organisations cooperate to agree on criteria based on need, poverty and vulnerability, which reflect governmental objectives and social values.

**3rd action**

149. The selection strategy, preliminarily formed as part of the transitional shelter programme plan, should be agreed upon and communicated to the affected population.

**4th action**

150. The beneficiary selection details should be circulated to the community. Members of the affected population may then be interviewed to gain their feedback.

**5th action**

151. Having communicated the preliminary beneficiary list to the affected population, support may be given to set up a grievance redress system/mechanism over an agreed period of time.

**6th action**

152. Having supported a complaints procedure, the final beneficiary list may be circulated to the beneficiaries and other stakeholders.

1

definition of TS  
10 TS principles  
5 characteristics  
when not to use TS  
SWOT

definition

2

decision-making tool

tool

3

coordination  
programme plan  
assessment  
**beneficiaries**  
labour  
materials  
procurement  
support  
quality assurance

programme

4

community  
site selection  
site planning  
land tenure  
handover

site

5

socio-cultural  
minimise risk  
climatic design  
materials  
construction

design

resources

## BALANCING BENEFICIARY NUMBERS TO LEVEL OF ASSISTANCE

153. Humanitarian responses are based on limited resources. In order to put these resources to use most efficiently it is necessary to concentrate on a specific balance between the level of assistance provided and the actual number of supported beneficiaries, shown in Diagram 3.5.

 **Attention: Consider levels of assistance**

In order to support most or all affected people, different levels of assistance based on how strongly affected beneficiaries are should be considered. Less affected families may for example be supported through cash grants.

**Diagram 3.5**  
Balancing beneficiary numbers to level of assistance

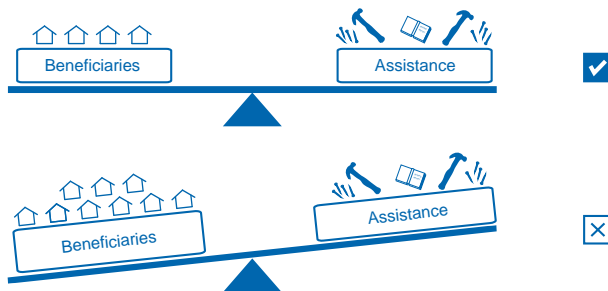

154. In order to establish balanced assistance, as both funding and resources are limited, the most vulnerable beneficiaries need to be clearly identified. In this process of identification, the following factors should be considered:

- ▶ equity -make sure that the given assistance does not lead to tensions or conflicts in the chosen community;
- ▶ vulnerability-the presence of highly vulnerable groups such as minorities, children, women or elderly;
- ▶ geographic location-proximity to natural resources, especially clean water;
- ▶ presence of other aid organisations-it may be reasonable to choose an area where no other organisation already addresses the needs of the population. However, in some situations the availability of partners may be necessary;
- ▶ communities still living in camps, who will need additional camp management support; and
- ▶ communities without access to basic services, such as water or education.

**The 18  
common  
assistance  
methods**

155. This section provides information about beneficiary identification in order to determine who within the affected population should receive what assistance, in order to understand and establish possible support methods.

**Assistance methods**

156. The ways of supporting all shelter, settlement and reconstruction activities, including transitional shelter, have been categorised in 18 assistance methods. In each transitional shelter project, a combination of these 18 methods should be selected and implemented, depending upon the context and beneficiaries identified.

157. The following 18 common assistance methods can be met either from external sources such as international donors, from within the capacity of the affected communities or from gifts received from friends and relatives working outside the area who are able to inject personal or private means.

158. The advantages of describing assistance include increasing the level of common understanding of programmes between stakeholders, as well as the possibility of coordinating assistance across programmes. For example, if both transitional shelter and WASH programmes use contracted labour for some activities, it might be possible to develop a single contract or use the same contractor.

159. The 18 common assistance methods shown in Diagram 3.6 should be combined in order to design and implement appropriate, equitable and consistent transitional shelter programmes in order to achieve the humanitarian objective.

1

definition

- definition of TS
- 10 TS principles
- 5 characteristics
- when not to use TS
- SWOT

2

tool

- decision-making tool

3

programme

- coordination
- programme plan
- assessment
- beneficiaries**
- labour
- materials
- procurement
- support
- quality assurance

4

site

- community
- site selection
- site planning
- land tenure
- handover

5

design

- socio-cultural
- minimise risk
- climatic design
- materials
- construction

resources

Diagram 3.6  
18 assistance  
methods

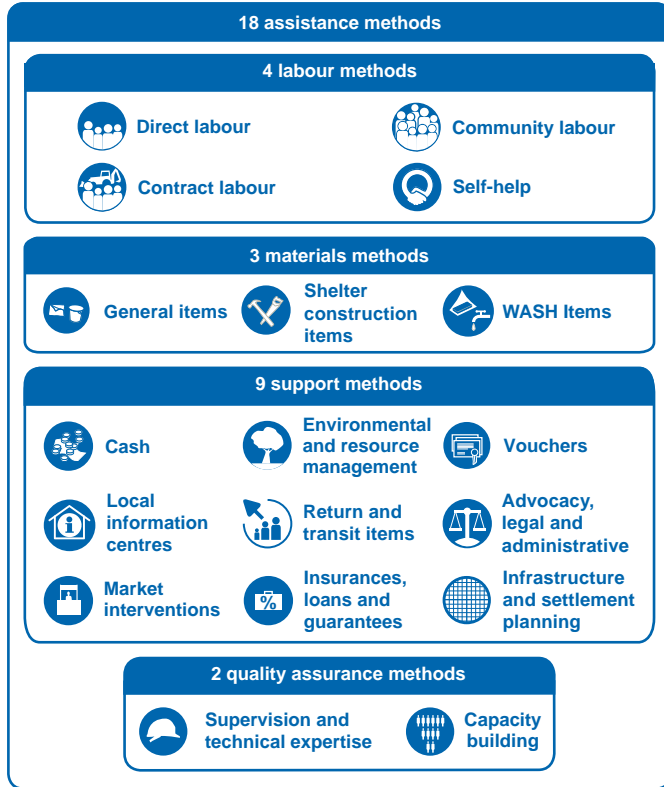

UN, 2010. *SAD*, p.98.

160. The assistance methods concerning labour are presented in the following section. The methods regarding materials and materials sourcing are presented in »3.6, procurement and logistics issues in »3.7, the nine support methods in »3.8 and quality assurance methods in »3.9.

## 3.5

# LABOUR METHODS

### Combination of labour methods

161. The four different labour assistance methods are direct, community, contract, and self-help labour. This section describes the appropriateness, challenges and benefits of each one of them, in order to help practitioners select appropriate approaches to labour. »Chapter 2, Decision-making tool, D1 Labour methods

162. In most shelter responses a combination of the four different labour methods may be necessary and may involve owners, contractors and communities at the same time.

163. Various factors may influence the choice of labour type and the degree of participation of the affected population in implementation. These include:

- ▶ the availability of local skills and resources;
- ▶ the presence of national technical capacity to provide support to transitional shelter self-help projects; and
- ▶ beneficiaries' seasonal livelihood priorities.

### 3.5.1



## DIRECT LABOUR

### When appropriate

164. Aid agencies may hire and manage labour directly to undertake construction activities, where distribution of remuneration, incentives and/or NFIs for the work done is functional to help those affected to recover. »Chapter 2, Decision-making tool, D1.3 Direct

165. This approach is most appropriate when the implementing agency is able to provide adequate support through its technical staff, such as architects, civil engineers, site planners and water and sanitation experts, in addition to experienced consultants.

### The challenges

166. The availability of skilled and unskilled labour force within the affected population may be limited in complex or large scale emergencies. Agencies may need to engage with national and international contractors for additional capacity in terms of workforce and technical expertise and supervision.

167. Coordination and management of direct labour should be carried out through continuous technical support and site supervision. People with competency and knowledge of local construction practices should be identified and considered for supervising construction units.

1

definition of TS  
10 TS principles  
5 characteristics  
when not to use TS  
SWOT

2

decision-making tool

3

coordination  
programme plan  
assessment  
beneficiaries  
labour  
materials  
procurement  
support  
quality assurance

4

community  
site selection  
site planning  
land tenure  
handover

5

socio-cultural  
minimise risk  
climatic design  
materials  
construction

definition

tool

programme

site

design

resources



**What to consider**

168. In order to maximise capacity building within communities, community representatives should be involved in construction management activities, such as the recruitment process, arrangement of work schedules, monitoring of attendance, payroll and dismissals.

**Key considerations**

169. Key considerations may include:
- ▶ direct labour may help the local economy to recover and provide additional means of livelihood to those directly and indirectly affected;
  - ▶ the availability of local workforce may be limited depending on the gravity and scale of the emergency. The aid agency may need to engage with national and international private contractors for extra labour; and
  - ▶ construction management should involve community representatives and master craftspeople to maximise capacity building.



3.6 Direct labour, Haiti 📷 David Sacca/Handicap International.

## 3.5.2 COMMUNITY LABOUR

**When appropriate**

170. Community labour may be organised as a collective effort where different groups within the affected population and the host community may be willing to undertake construction activities together on a voluntary basis. » Chapter 2, Decision-making tool, D1.2 Community

**The challenges**

171. Social cohesion, distribution and location of the affected population may directly influence the effectiveness of a construction programme based on community labour.

**What to consider**

172. Implementing agencies should initiate community mobilisation and outreach campaigns for dissemination of good construction practices, in order to ensure that these are further communicated and replicated. » 3.1.6

**Key considerations**

- 173. Possible considerations to be addressed include:
  - ▶ assessment of local building traditions and construction skills; »3.3
  - ▶ consideration of social cohesion and distribution of communities over the affected territory; and
  - ▶ dissemination of good construction practices and technical guidance through community mobilisation and outreach programmes. »3.1.6



3.7 Community labour, Pakistan 📍 Marco Botelli/IOM Pakistan.

**3.5.3**



**INTERNATIONAL AND NATIONAL CONTRACT LABOUR**

174. A distinction between international and national private contractors has to be made. If possible, national private contractors should be preferred since this option is more likely to stimulate the local economy and create temporary livelihood options.

**When appropriate**

175. Contractors may be hired to provide additional capacity in complex situations. This may happen in cases of large scale projects that need to be implemented in short periods of time, where construction activities require specialist skills for implementing hazard resistant measures and when communities have no tradition of self-building. »Chapter 2, Decision-making tool, D1.4 Contract

**The challenges**

176. Private contractors may set up construction workshops insitu, bringing the company workforce and importing raw materials or help to pre-assemble parts. In certain situations this may offer a significant contribution in terms of professional capacity and experience. However, international private contractors should only be considered if there are no other possible options as it may severely damage the local economy and does not contribute to transitional shelter. »1.2: Principle 2, Involve community

1

definition of TS  
10 TS principles  
5 characteristics  
when not to use TS  
SWOT

definition

2

decision-making tool

tool

3

coordination  
programme plan  
assessment  
beneficiaries  
**labour**  
materials  
procurement  
support  
quality assurance

programme

4

community  
site selection  
site planning  
land tenure  
handover

site

5

socio-cultural  
minimise risk  
climatic design  
materials  
construction

design

resources

<b>What to consider</b>	<p>177. Local building materials and designs should be used when possible, and involvement of the affected communities in the construction activities should be encouraged. Implementing agencies should engage with contractors and monitor construction works, in order to ensure that in addition to contractual specifications, national and international codes and standards are met, along with local cultural needs. This should be done by technical specialists aware of these constraints and requirements. In addition it has to be considered that contractors usually provide an “end-product” which makes changes during implementation difficult and costly.</p>
<b>Key considerations</b>	<p>178. The following key considerations should be addressed:</p> <ul style="list-style-type: none"> <li>▶ contract labour may provide additional capacity and specific technical expertise in complex emergencies and/or large scale projects;</li> <li>▶ participation of affected communities and use of local designs, materials and tools should be encouraged; and</li> <li>▶ implementing agencies should identify technical specialists for engaging with contractors and supervise construction works.</li> </ul>
<b>Tendering methods</b>	<p>179. A tendering process is required to choose a suitable contractor or firm. Candidates can be selected on the basis of a public tender open to any firm, an invited tender where firms are pre-selected and invited to submit their pilot study and offer, or invited competition where a jury will select the best proposal. 📖 University of Cambridge, 2005. <i>Transitional Settlement Displaced Populations (TSDP)</i>.</p>
<b>Accountability and transparency</b>	<p>180. Tendering represents an opportunity for contractors to be selected on the basis of an equal and transparent process, and allows donors and aid agencies to ensure reliability of service providers by formally specifying costs, time and quality conditions on the basis of national and international standards.</p>
<b>Appointment of contractors</b>	<p>181. It may be possible to directly appoint a contractor on the basis of reputation or established experience in providing a specific service or in a specific context. However, contractors should be approved by and registered with local authorities in order to work within the affected country. 📖 University of Cambridge, 2005. <i>TSDP</i>.</p>
<b>Contract documents</b>	<p>182. Terms of the contract should legally define the mutual responsibilities between the aid agency and contractors, sub-contractors, external consultants and other stakeholders. Make sure that a contract management structure is in place to ensure quality and conditions are met. All relevant documents forming the contract should clearly explain the relations between the parties, including:</p> <ul style="list-style-type: none"> <li>▶ conditions of the contract;</li> </ul>

- ▶ copy of the bid form;
- ▶ contract drawings and specifications;
- ▶ bill of quantities;
- ▶ a detailed working plan with schedule of payments, expected completion date/period, penalty clauses and requirements for labour and/or specific equipment; and
- ▶ an agreement.

The bid form is submitted to the agency by each contractor participating in the tender and includes an estimate of quantities, in terms of volume of works and materials required, with rates and costs expected. During the construction process, the implementing agency should identify a technical coordinator/specialist in charge of engaging with contractors and verify the quality of work. 📖 University of Cambridge, 2005. *TSDP*.

 **Attention: Contract management**

**Make sure that a strong business focused contract management structure is in place in order to enforce contracted services according to agreed qualities.**

183. Each transitional shelter programme should assess the combination of labour methods appropriate for the specific situation. Using this section, practitioners should be able to identify the key considerations that will inform an adequate decision.

### 3.5.4 SELF-HELP LABOUR

**When it is appropriate**

184. Self-help labour is the most participatory labour type and most appropriate when affected communities have a strong tradition of self-building. Transitional shelters can be built by the beneficiaries themselves, when sufficient construction skills are available and disaster risk reduction measures are understood and integrated into traditional building techniques. >Chapter 2, Decision-making tool, D1.1 Self-help

**The challenges**

185. Livelihood priorities and climate constraints should be taken into consideration as they may slow down or interrupt the construction process. Beneficiaries may have prior livelihood/household commitments, such as seasonal harvesting and fishing, and may need to employ a combination of local labourers, for example local contractors, unskilled labourers or family members to speed up the construction process.

**What to consider**

186. In order to minimise risk of recreating pre-existing vulnerabilities, self-help methods should be supported with adequate technical skills training, construction supervision and quality assurance on behalf of the implementing agency.

1

definition of TS  
10 TS principles  
5 characteristics  
when not to use TS  
SWOT

definition

2

decision-making tool

tool

3

coordination  
programme plan  
assessment  
beneficiaries  
labour  
materials  
procurement  
support  
quality assurance

programme

4

community  
site selection  
site planning  
land tenure  
handover

site

5

socio-cultural  
minimise risk  
climatic design  
materials  
construction

design

resources

**Key considerations**

187. Possible considerations to be addressed include:
- ▶ assessment of local building traditions and beneficiaries' construction skills; »3.3
  - ▶ provision of technical assistance through field supervision, quality control and skills training;
  - ▶ provision of tools and technical equipment for families building their own shelters;
  - ▶ consider livelihood priorities that may slow down or interrupt the construction process; and
  - ▶ consider staged material distribution to avoid a high rate of material resale prompted by a livelihood struggle.



3.8 Self-help labour, Pakistan 📷 IOM Pakistan.

## 3.6

# MATERIALS METHODS AND SOURCING

188. In this section, guidance is offered on the sourcing of shelter construction items. The sourcing of materials plays a significant role in the transitional shelter process. The following chapter helps practitioners to make adequate decisions concerning this topic. »Chapter 2, Decision-making tool, D2 Materials methods

## 3.6.1 MATERIALS METHODS

189. The following three assistance methods relate to distribution of materials: general items, shelter construction items and WASH items.

### General items



190. General items may be defined as those that can be distributed without additional instruction, promotion or education. These are usually distributed in both emergency and recovery phases. They are mainly distributed in the form of packs that differ in content according to the specific context in which they are needed. 📖 UN, 2010. *SAD*, p.118.



3.9 General items emergency packs, Pakistan 📖 IOM Pakistan.

### Shelter construction items



191. Shelter construction items may be defined as those that need additional instruction, promotion or awareness-raising. These can include toolkits, shelters or construction materials.

192. Shelter construction items are distributed immediately after the disaster, once the decision to retrofit, repair or rebuild has been made, and subsequently throughout the response until recovery objectives have been achieved. 📖 UN, 2010. *SAD*, p.119.

1

definition of TS  
10 TS principles  
5 characteristics

when not to use TS

SWOT

2

decision-making tool

3

coordination  
programme plan

assessment

beneficiaries

labour

materials

procurement

support

quality assurance

4

community

site selection

site planning

land tenure

handover

5

socio-cultural

minimise risk

climatic design

materials

construction

definition

tool

programme

site

design

resources



## WASH items



193. WASH items are typically those that need additional instruction, promotion or education. These can include, for example, mosquito nets and household water treatment. These items are usually distributed immediately following a disaster and throughout the response. They are distributed in the form of packs that differ in content according to the specific context in which they are needed.  UN, 2010. *SAD*, p.119.

## 3.6.2 SOURCING MATERIALS

### Introduction

194. Humanitarian responses are based on donor funding and should lead to the improvement of quality of life of beneficiaries. Certain principles should be applied to guarantee transparency and efficiency. For further information please refer to  *Logistics Cluster, Homepage* [online].

### Material identification

195. In the first stage of the procurement process it is crucial to identify which NFIs will be necessary for the construction of transitional shelters. This decision has to be taken in cooperation with the beneficiaries in order to ensure their support, enhancing the sustainability of the decision. » 1.2, Principle 2: Involve community

### Key considerations

196. The following key factors should be considered when identifying materials:

- ▶ what materials the beneficiaries are familiar with, and if they know how to use them;
- ▶ if the beneficiaries have the necessary skills to repair and maintain the commodity and its parts and tools;
- ▶ if the material can be replaced when necessary;
- ▶ if the material is appropriate within the beneficiaries' cultural values and standards;
- ▶ which materials are readily available;
- ▶ quality and lifespan of the material; and
- ▶ if all risk factors of possible materials have been assessed.

### General sourcing considerations

197. Apart from the specific considerations regarding the identification of materials, the following general key factors should be included within the process:

- ▶ ethical concerns such as the use of child labour or other human rights violations;
- ▶ environmental concerns such as the use of hazardous chemicals in material processing; and
- ▶ positive and negative economic impacts such as negotiation of trade arrangements or distortion of the local economy.



### 3.6.3 LOCAL SOURCING

#### Definition

198. Materials can be procured from local sources through existing markets »Chapter 2, Decision-making tool, D2.1 Local. This option is preferable for transitional shelter approaches since it generally complies with the 10 transitional shelter principles »1.2. However, it should be considered that demand for materials increases significantly after disasters, and damaged local sources may rarely be able to meet these emergency needs.

#### Benefits

199. As mentioned above local sourcing should be encouraged wherever possible due to a number of benefits:

- ▶ support of local economy;
- ▶ possible creation of livelihood opportunities;
- ▶ can build local capacities;
- ▶ possible reduction in tensions between displaced and local communities by spreading the benefits of aid beyond the displaced population;
- ▶ reduction in delivery and lead times; and
- ▶ less transport problems.

#### Risks

200. Local sourcing can also have a variety of negative effects on a transitional shelter programme:

- ▶ lack or sudden disruptions of local material supply;
- ▶ sudden price increases on local markets due to unusually high demand;
- ▶ transport and storage problems;
- ▶ severe environmental impacts such as deforestation; and
- ▶ conflicts within the population may arise due to a lack of available materials.

#### Key considerations

201. Key considerations to be addressed include:

- ▶ consider arrangements such as phased procurement schemes between responding organisations to avoid sudden price increases due to uncoordinated local purchase;
- ▶ assess market support possibilities to strengthen supply;
- ▶ consider carbon footprint caused by sourcing of materials;
- ▶ if a number of suppliers meet given requirements choose materials with less environmental impact; and
- ▶ develop policies to ensure equal access to natural resources.

1

definition of TS  
10 TS principles  
5 characteristics  
when not to use TS  
SWOT

definition

2

decision-making tool

tool

3

coordination  
programme plan  
assessment  
beneficiaries  
labour  
**materials**  
procurement  
support  
quality assurance

programme

4

community  
site selection  
site planning  
land tenure  
handover

site

5

socio-cultural  
minimise risk  
climatic design  
materials  
construction

design

resources



### **Tip: Consider using local procurement agents or importers**

The use of local procurement agents/importers can provide significant benefits since they know import and customs procedures. In addition they possess storage facilities and knowledge of distribution/transport methods. Using local import companies may also provide livelihood opportunities for beneficiaries.



### **Field experience: Aceh province tsunami, 2004—Sustainable material sourcing**

In 2004 an earthquake of magnitude 9 on the Richter scale triggered a tsunami that devastated the coastal areas of a number of countries of the Indian Ocean. In the Aceh province of Indonesia approximately 252,000 buildings were destroyed. In addition to the masonry needs of reconstruction, initial calculations estimated the required volume of timber at 300,000–400,000m<sup>3</sup>.

Harvesting and supply of timber in Indonesia is a critical issue, much of it being illegal. Inadequately managed logging and associated activities increase the risk of flooding, soil erosion, potential for landslides and loss of biodiversity. UN-HABITAT and IFRC, 20010. *Shelter Projects 2009*, p.58, UNEP and SKAT, 2007. *After The Tsunami*, p.10.

## **3.6.4 INTERNATIONAL SOURCING**

<b>Definition</b>	202. Certain items will have to be procured from international sources due to a lack of national availability. These are normally items which have long lead times. In some cases international sourcing may also be used for stockpiling. »Chapter 2, Decision-making tool, D2.3 Imported
<b>Benefits</b>	203. International sourcing may offer some of the following benefits in post-disaster environments: <ul style="list-style-type: none"> <li>▶ availability of needed materials;</li> <li>▶ better and more stable prices; and</li> <li>▶ materials comply with international quality standards.</li> </ul>
<b>Risks</b>	204. International sourcing should generally be a secondary option due to the following disadvantages: <ul style="list-style-type: none"> <li>▶ long distance transport negatively impacts the environment;</li> <li>▶ long lead and delivery times;</li> <li>▶ materials may get damaged during long distance transport;</li> </ul>

**Key considerations**

- ▶ necessity of large, appropriate and secure storage facilities;
  - ▶ no input to the local economy;
  - ▶ transport to the affected area may not be possible due to destruction of infrastructure; and
  - ▶ costs for transport and customs may be significant making international procurement costly.
205. These key considerations should be addressed:
- ▶ assess if materials can be procured through an existing international framework;
  - ▶ make sure environmental impacts of long distance transport have been considered;
  - ▶ assess if procured materials can actually be delivered to the affected area; and
  - ▶ calculate costs for transport and customs.

### 3.6.5 PREFABRICATED PARTS

**Definition**

206. Although the international import of completely prefabricated shelter units cannot be an option for a transitional shelter approach, the local prefabrication of components might be beneficial. Nonetheless, prefabrication has to be considered carefully, when implemented as part of a transitional shelter approach »Chapter 2, Decision-making tool, D2.2 Prefabricated parts



3.10 Locally sourced prefabricated timber frame panels, Haiti  
 Cordaid Haiti.

**Benefits**

207. Local prefabrication can offer following the following benefits:
- ▶ prefabricated components may be easier to disassemble and relocate;
  - ▶ prefabrication may speed up the construction process;

1

definition of TS  
10 TS principles  
5 characteristics  
when not to use TS  
SWOT

2

decision-making tool

3

coordination  
programme plan  
assessment  
beneficiaries  
labour  
**materials**  
procurement  
support  
quality assurance

4

community  
site selection  
site planning  
land tenure  
handover

5

socio-cultural  
minimise risk  
climatic design  
materials  
construction

definition

tool

programme

site

design

resources

- ▶ prefabrication can lower costs of shelters due to standardised work steps;
- ▶ prefabrication can be conducted in workshops ensuring technical standards and principles are adhered to; and
- ▶ beneficiaries may receive training in prefabrication workshops.

**Risks** 208. Depending on the specific situation, prefabrication may pose a variety of risks:

- ▶ the local building culture may not be used to prefabricated components and therefore be unable to repair damaged parts;
- ▶ transport of prefabricated parts to the site may be difficult;
- ▶ materials for future repairs and maintenance may not be available;
- ▶ culturally appropriate materials may not be suitable for prefabrication; and
- ▶ approach may lead to provision of completely prefabricated shelter units.

**Key considerations** 209. The following considerations should be addressed:

- ▶ assess if prefabrication is part of the local building tradition;
- ▶ try to involve beneficiaries in the prefabrication to disseminate technical training;
- ▶ ensure prefabricated components are constructed from materials beneficiaries are used to; and
- ▶ involve communities in assembling prefabricated parts to enable them to replace and repair components.



**Attention: Import of prefabricated shelter units**

The international procurement and import of complete, prefabricated shelter units cannot be an option for a transitional shelter approach, since it contradicts numerous principles of transitional shelter. » 1.2

210. This section has provided guidance on the sourcing of shelter construction items. The sourcing of materials plays a significant role in the transitional shelter process. The following chapter provides guidance on procurement bearing in mind that adequate material sourcing is fundamental to ensure an efficient procurement process.

## 3.7

# PROCUREMENT AND LOGISTICS

211. This section goes through procurement and logistics issues, with specific reference to their importance regarding a transitional shelter approach.

### 3.7.1

## INTRODUCTION TO PROCUREMENT AND LOGISTICS

212. The different stages of the procurement process are summarised in Diagram 3.7 below.

Diagram 3.7  
The procurement process

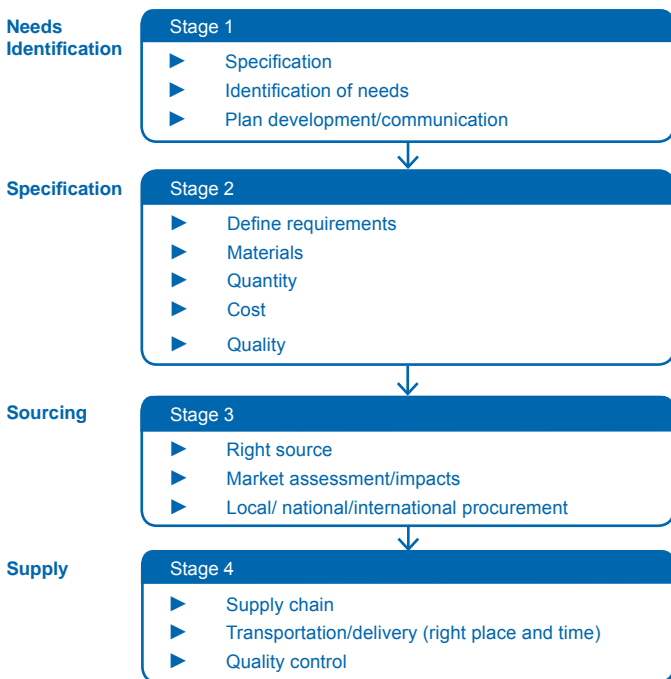

The procurement process

213. Appropriate materials are the basis of every transitional shelter. This makes procurement and logistics the most essential step within the transitional shelter approach. The process includes several stages from the identification and availability of NFIs to the distribution to beneficiaries.

1

definition of TS  
10 TS principles  
5 characteristics  
when not to use TS  
SWOT

definition

2

decision-making tool

tool

3

coordination  
programme plan  
assessment  
beneficiaries  
labour  
materials  
procurement  
support  
quality assurance

programme

4

community  
site selection  
site planning  
land tenure  
handover

site

5

socio-cultural  
minimise risk  
climatic design  
materials  
construction

design

resources

**Principles of humanitarian procurement**

214. Humanitarian responses are based on donor funding and should lead to the improvement of quality of life of beneficiaries. The objective of properly conducted procurement in the humanitarian context is to meet six basic goals generally referred to as the six “rights” of procurement:

- ▶ right quality;
- ▶ right source;
- ▶ right cost;
- ▶ right quantity;
- ▶ right place; and
- ▶ right time.

215. In order to meet these goals the following three basic principles have to be applied:

- ▶ transparency-fair and accurate documentation;
- ▶ accountability to donors; and
- ▶ efficiency and cost effectiveness.

216. Demand for materials increases markedly following disasters. Local sources take a significant time to recover and regain their original capacities. As a result they are rarely able to provide a sustainable supply for emergency needs.

217. The environmental impact of the procurement and logistics stage should be considered as part of the wider programme. It should consider, for example, the life cycle and sustainability of source materials and other social, environmental and economic factors at both local and global level.

218. Diagram 3.8 shows the evolution in post-disaster supply demands.

**Diagram 3.8**  
**Post-disaster supply demands**

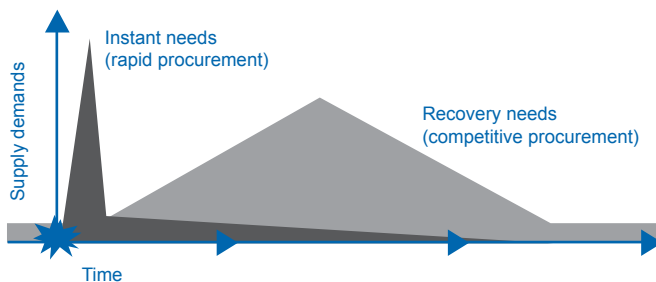

**Disruptions in production**

219. Decreases in supply can commonly be traced back to disruptions in production. These disruptions may include:

- ▶ workforce is no longer available;
- ▶ shortages of raw materials;
- ▶ damages to production plants or power supplies; and

- ▶ seasonality of specific materials.

📖 The World Bank, 2010. *Safer Homes, Stronger Communities*.

220. Additionally the following logistics breakdowns and transportation interruptions may influence the availability of necessary materials:

- ▶ damage to access routes;
- ▶ reduction of transport capacities e.g. damaged trains or high demand for trucks;
- ▶ security issues; and
- ▶ barriers such as border crossings.

📖 The World Bank, 2010. *Safer Homes, Stronger Communities*.



**Case study: Afghanistan conflict, 2009—Logistics disruption**

A temporary transit facility was developed in the Sozma Qala area of the Sar i Pul province of Afghanistan in order to house conflict returnees. Initially intended as a temporary solution, by October 2009 it became clear additional provision was needed to ensure tents were able to withstand the onset of winter. However, due to poor weather conditions, insecurity and border procedures bamboo and plastic sheeting procured internationally to winterise the transit camp tents were subject to delays. Over a six week construction process, 12 days were lost awaiting delivery of these materials. 📖 UN-HABITAT and IFRC, 2010. *Shelter Projects 2009*, p.3–5.



3.11 Transitional shelter stockpiles, Leogane/Haiti 📷 Cordaid Haiti.

221. Transitional shelter should be implemented in the first phase of the humanitarian response so it is vital to rapidly procure certain NFIs. Plastic sheeting, with some basic structural elements and tools, which can later be integrated

1

definition

definition of TS  
10 TS principles  
5 characteristics  
when not to use TS  
SWOT

2

tool

decision-making tool

3

programme

coordination  
programme plan  
assessment  
beneficiaries  
labour  
materials  
procurement  
support  
quality assurance

4

site

community  
site selection  
site planning  
land tenure  
handover

5

design

socio-cultural  
minimise risk  
climatic design  
materials  
construction

resources

into a locally produced transitional shelter, or stockpiled into transitional shelter kits, would commonly be the first material procured for a transitional shelter project. There are three major ways in which rapid procurement can be conducted to cope with supply shortages in the early stages of the response. These are frame agreements, stockpiles or immediate purchase.

**Rules and regulations** 222. In the beginning it is important to check the procurement policies operated by the implementing agency, donors, or local authorities, as these will need to be addressed.

**Stockpiles** 223. The use of national or international government or agency stockpiles is one possible solution during the early stages of transitional shelter programmes to accelerate the distribution of basic items such as plastic sheeting. Furthermore it should be explored if stockpiled transitional shelter kits are available.

**Framework agreements** 224. If it is necessary to procure urgently needed items from international sources it should be made clear whether the implementing agency is holding framework agreements with international suppliers. Framework agreements are formal standing contracts with manufacturers to deliver items at a fixed price. This option can significantly reduce lead times while guaranteeing desired qualities and prices. Sometimes the terms “open contract” or “pre-qualified supplier” are also used in this context.

**Immediate purchase** 225. NFIs can be purchased directly from a selected supplier with sufficient capacity, which can be of local, national or international origin. Though this option may be quicker and less complicated than competitive procedures it also introduces the risk of purchasing at an exaggerated price and therefore exceeding budget limits and distorting local market structures.

**Competitive procurement** 226. When immediate needs have been covered by the above mentioned options, further procurement should be conducted in a competitive way in order to ensure reasonable prices and transparent purchasing. Competitive procurement is generally conducted through one of the following two options:

- ▶ requesting and receiving quotations where a limited number of vendors are invited to submit bids; or
- ▶ requesting and receiving tenders where a request for bids for NFIs is advertised openly on the local and/or international market. All interested suppliers can submit bids until the end of the set deadline.

## 3.7.2 MARKET ASSESSMENT

**Market assessment** 227. It is important to understand the role of local market systems before deciding where to source materials since the procurement of large quantities of goods and services can have a variety of effects on local markets, both positive and negative.



The emergency market mapping and analysis assessment tool can be used to assess the suitability of procuring materials locally and to identify opportunities and actions needed to restore and support critical market systems.

**The EMMA tool**

228. The EMMA tool can be used to assess the three vital strands of local market systems: people, market and response. By assessing these three aspects of a market system it is possible to determine the most affected groups, capabilities and constraints of the market and feasible response options. It is designed to be used by generalists as well as shelter specialists. 📖 Oxfam, 2010. *EMMA Toolkit*.

**Market support**

229. For information on support possibilities of local markets through a market intervention, please refer to »3.8.4.

### 3.7.3 SUPPLY CHAIN

**Definition**

230. Supply chain management is defined as: “The ability to deliver the right supplies to the right place at the right time and in the right quantities.” 📖 UNHCR, 2007. *Handbook for Emergencies*.

**Transport**

231. Transportation is a key factor in the supply chain. The aim of supply chain management is to conduct the delivery of purchased items in the most time and cost efficient manner, while ensuring that losses due to damage caused by transport are kept to a minimum.



3.12 Distribution by boat, Sindh/Pakistan 📷 Chris Lom/IOM Pakistan.

**International transport**

232. When NFIs are procured internationally, a wide variety of means of transportation will be involved. These may include air, sea, rail and/or road shipment. A variety of transport modes can negatively impact the environment and should be avoided whenever possible.

**Local transport**

233. Locally procured goods are mainly shipped by road and less often by rail, since affected countries often lack an

1

definition of TS  
10 TS principles  
5 characteristics  
when not to use TS  
SWOT

definition

2

decision-making tool

tool

3

coordination  
programme plan  
assessment  
beneficiaries  
labour  
materials  
procurement  
support  
quality assurance

programme

4

community  
site selection  
site planning  
land tenure  
handover

site

5

socio-cultural  
minimise risk  
climatic design  
materials  
construction

design

resources

established railway system. Therefore a number of factors should be considered:

- ▶ losses in transit of materials damaged during transportation should be factored into project planning, as this can commonly be over 10%, and additional materials should be ordered to compensate;
- ▶ losses in transit may be reduced by minimising double handling and by improving packing; and
- ▶ for final distribution, bicycles, hand carts or animals may be necessary, and it is important to assess how supplies are normally transported locally.

234. The number of stages in the distribution chain should be kept to a minimum to reduce the amount of double handling and loss in transit as shown in Diagram 3.9.

**Diagram 3.9**  
**Planning**  
**an efficient**  
**distribution**  
**chain**

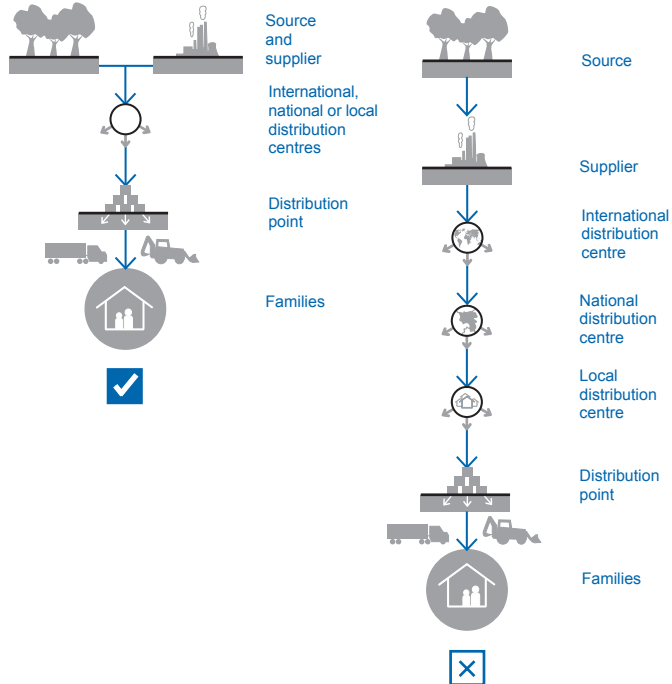

**Tracking**  
**system**

235. Ensure that a proper tracking system is established. At each distribution point waybills must be signed in order to track distributions from start to finish. Also, ensure that the finance department is informed as goods are moving through the supply chain in order to correctly reflect the physical inventory in the financial balance sheets. It is vital that all involved employees can be held accountable at every stage of the distribution process.

## Stockpiling

236. Procured materials can also be stockpiled in order to be able to respond to future major emergencies. Stockpiles must be:

- ▶ protected from bad handling, improper stacking and climatic effects;
- ▶ accessible in all weathers;
- ▶ organised so that handling and distribution are kept to a minimum; and
- ▶ protected from theft and pests.

## Selecting the distribution site

237. Sites selected for distribution of NFIs to beneficiaries must meet certain standards. When choosing a site, consider the following factors:

- ▶ provision of shade, water and latrines for beneficiaries while queuing;
- ▶ the long-distance beneficiaries have to travel to reach the distribution site;
- ▶ local transport and road systems-whether access for vehicles carrying goods is likely to be blocked by beneficiaries;
- ▶ secure location for the beneficiaries;
- ▶ evacuation route for staff, in case of security problems; and
- ▶ proximity to military or security establishments or other sensitive areas.

 Logistics Cluster, *Homepage* [online].



3.13 **Shade provision at distribution site, Pakistan**  IOM Pakistan.

## Managing the distribution site

238. When planning the layout of the distribution site attention should be paid to the following factors, with special care given to security and the protection of vulnerable individuals:

- ▶ consider how vulnerable groups within the population will be able to receive distributed shelter construction items, possibly including more localised deliveries and delivery

1

definition of TS  
10 TS principles  
5 characteristics  
when not to use TS  
SWOT

definition

2

decision-making tool

tool

3

coordination  
programme plan  
assessment  
beneficiaries  
labour  
materials  
**procurement**  
support  
quality assurance

programme

4

community  
site selection  
site planning  
land tenure  
handover

site

5

socio-cultural  
minimise risk  
climatic design  
materials  
construction

design

resources

to certain groups through community leaders or through “door to door” distribution;

- ▶ consider how beneficiaries will transport materials to their homes, as they will not be able to take many trips after leaving the distribution area, so the overall weight of materials and distance of travel are important;
- ▶ consider security and whether police involvement would be helpful and, where possible, have the labour force that unloaded the trucks to double as security, to prevent unauthorised access and possible looting of goods;
- ▶ ensure that the quantity of goods available on the day is enough to supply the needs of all those eligible, as shortages of goods could cause tension or disturbance;
- ▶ try to minimise the amount of time spent queuing and provide water and shade if it is hot, possibly using the opportunity for consultation;
- ▶ a distribution site should be divided into a registration area, where beneficiaries report and are checked against names on a list;
- ▶ the actual distribution area should be adjacent to the registration site but with controlled access, so that only registered people queue for distribution, ideally enabling the storage area to be resupplied via a truck while distributions are on-going;
- ▶ spend time organising the site, for example to optimise the flow of people and ensure there is sufficient space for waiting, dividing groups so that crowds do not exert pressure on those at the front; and
- ▶ spend time in advance to streamline and verify the beneficiary list.



3.14 Distribution site considerations, Pakistan  IOM Pakistan.

239. Further information on distribution systems and planning of distribution sites is available in  University of Cambridge, 2005. *TSDP*, p.300.

## 3.8 SUPPORT METHODS

### 3.8.1 CASH

#### Definition

241. This support method consists of the direct distribution of cash to the affected population.

#### When appropriate

242. Cash payment stands as the most flexible and immediate resource for supporting beneficiaries. This option is advisable when the cash distribution can be ensured by reliable banking facilities for the entire duration of the project. One should prevent the exposure to security risks of both the beneficiaries and distribution staff.

#### Risk of inflation of prices

243. If the availability of construction materials and tools is not enough to satisfy needs, the direct distribution of cash may generate inflation of prices.

#### Cash distribution

244. The distribution of cash should be done in sections, according to the different phases of construction, preferably after specific work stages are completed in order to ensure that the cash is used for the intended purposes. This distribution should be combined with a monitoring and supervision process of the construction work, done by building inspectors, making sure that all safety standards and quality of construction are met.



#### **Case study: Ingushetia conflict displaced, 1999—cash for shelter**

Following the second conflict in Chechnya up to 150,000 people were accommodated by host families in neighbouring Ingushetia. Cash grants provided by an international donor and the leading international agency for shelter assistance were given to every host family to ensure displaced people were not evicted during winter. The success of these one-off grants in 2000/01, equivalent to one month's income, led to a second phase implementation.  UN-HABITAT and IFRC, 2010. *Shelter Projects 2009*, p.19.

1

definition of TS

10 TS principles

5 characteristics

when not to use TS

SWOT

2

decision-making tool

3

coordination

programme plan

assessment

beneficiaries

labour

materials

procurement

support

quality assurance

4

community

site selection

site planning

land tenure

handover

5

socio-cultural

minimise risk

climatic design

materials

construction

definition

tool

programme

site

design

resources



### Tip: Mobile phone pin transfers

Pin transfer by mobile phone may be used to avoid carrying huge amounts of cash and to reduce security risks.

## 3.8.2



## VOUCHERS

### Definition

245. Vouchers can be an alternative method to cash distribution. These are given in exchange of materials and services provided by selected local suppliers.

### When appropriate

246. Vouchers are often used if there are security concerns surrounding cash distribution. These are also used as a way to control inflation.

247. This method may be an opportunity for encouraging sourcing of materials locally, rather than using imported materials.

248. Vouchers may also help tracking which items are most popular or needed in a specific situation.

### Selection of local suppliers for voucher scheme

249. In order to avoid generating corruption and/or unfair competition which may undermine local businesses, the process of selecting the suppliers should be completely transparent.

## 3.8.3



## INSURANCES, LOANS AND GUARANTEES

250. During a time of lack of direct access to credit, insurance, loans and guarantees may be provided by the government, aid agencies, national banks and donors. This solution is appropriate when later repayment and collection of materials and services are feasible.

### When appropriate

251. Insurance, loans and guarantees may be considered when:

- ▶ financial and hazard risks are well understood;
- ▶ risk management and quality assurance can be achieved;
- ▶ later repayment and collection are feasible; and
- ▶ access exists to relatively stable supplies of materials and services.

### Loan access

252. Use of soft loans may ensure more financial independence for the recipients and even avoid beneficiaries being concerned with the social stigma of receiving charity.

### Potential rise of social insecurity

253. However, repayment of a loan may represent an unaffordable financial burden for the beneficiaries, for example due to the inability to cover the initial down payment or due to unclear government regulations for lenders, and may contribute to increasing social insecurity and vulnerability, where the

land or property of affected households may be required as a guarantee.

### 3.8.4



## MARKET INTERVENTIONS

#### Definition

254. Market intervention is the continuous and comprehensive assessment and involvement of the construction industry, from material resources to contractors and professional bodies. It identifies and responds to capacities, opportunities, linkages, and interruptions, and ensures that the private sector better serves the affected population, for example in supporting existing suppliers by providing thatch for roofing.

#### When appropriate

255. Market mapping and analysis should be undertaken as early as possible. This is done in order to provide a better understanding of capacities, bottlenecks and gaps in the market and discrepancies between supply and demand. Interventions should only be based on the result of mapping and analysis.



#### Attention: Mandate and expertise

Though it is generally important for staff of NGOs to understand the implications of market interventions, NGOs may not have the mandate or the necessary expertise to engage in such interventions.

#### Interruptions and disruptions in local supplies

256. Local markets and suppliers may require additional support to ensure that sufficient materials and tools are provided throughout the duration of the shelter programme. Some sectors may have been seriously impacted by the conflict or disaster, for example locally manufactured building components and materials may be scarce, or essential services may need to be restored or improved to better respond to the emergency.

#### Use of the EMMA tool

257. Emergency market mapping and analysis » 3.7.2, should be undertaken to understand where the main interruptions and disruptions have occurred in the market system due to the emergency.

#### Involvement of the private construction industry

258. Market interventions should be implemented as a result of assessment of needs and availability of materials, technical specialists and contract labour. Identified gaps may be filled through community or humanitarian capacities. If specialist skills, equipment or capacity is required, the construction industry should be involved. There is no reason why the construction industry may not contribute productively to humanitarian objectives, as long as they are managed by experienced and technically competent humanitarian stakeholders.

1

definition of TS

10 TS principles

5 characteristics

when not to use TS

SWOT

2

decision-making tool

3

coordination

programme plan

assessment

beneficiaries

labour

materials

procurement

support

quality assurance

4

community

site selection

site planning

land tenure

handover

5

socio-cultural

minimise risk

climatic design

materials

construction

definition

tool

programme

site

design

resources



### 3.8.5



## LOCAL INFORMATION CENTRES

#### Definition

259. A network of information centres at local and regional levels can help to provide necessary information to the affected population on what assistance is available and how it can be accessed. Information centres may be located in or near existing communal facilities, such as schools or clinics, or may be mobile, arriving in each community at certain times during the week.

#### When appropriate

260. Local information centres offer opportunities for consultation and assistance to the affected population. These should be established as early as possible during the emergency phase.

261. Their activity should be integrated within the monitoring and evaluation process. It provides feedback both to the agency information manager, assessment teams and the beneficiaries.

#### What information may be offered to the affected population?

262. Information centres should be used to make community groups aware of what assistance is available and how it can be accessed. Relevant information may include:

- ▶ explanation of what the shelter strategy means and details of the transitional shelter programme;
- ▶ how to get access to the shelter assistance offered, including special support programmes for the most vulnerable groups;
- ▶ access to complementary services offered by the government and implementers, such as counselling and legal assistance over land right issues and land allocation issues;
- ▶ livelihood opportunities, such as cash for work programmes and contracting labour;
- ▶ indication of safe areas for return and relocation, through simplified hazard risk mapping;
- ▶ early warning systems and preparedness measures;
- ▶ technical advice about how to incorporate disaster risk reduction measures into self-help building techniques; and
- ▶ complaint systems, including legal aid.

### 3.8.6



## ADVOCACY, LEGAL AND ADMINISTRATIVE

#### Definition

263. To offer complementary support to beneficiaries of transitional shelter programmes, providing free or low cost legal and administrative assistance especially concerning property rights and tenure issues.

#### When appropriate

264. Structures for advocacy, legal and administrative assistance should be established for counselling and advice at reduced costs or free of charge. A solid legal framework is needed to ensure that



the affected population, especially the most vulnerable groups, and host communities are aware of their rights.

**Assistance in tenure**

265. The appropriate assistance should be given to the affected population in a range of issues related to land and property rights, land and housing agreements, land allocation issues, rental laws, property restitutions, state requisition and land registers.

266. National legislation should be taken as the official legal framework. Eventual gaps and inconsistencies within the existing legal framework should be identified and agencies should advocate/encourage public authorities to solve those issues, using international principles and standards as reference.

**3.8.7**



**RETURN AND TRANSIT ITEMS**

**Definition**

267. For those within the affected populations who have lost their land, properties and important means of livelihood as a consequence of disaster, and wish to return to their land or relocate to new and safer areas, support should be provided, in the form of return and transit packages.

**When appropriate**

268. Transit package items may include a wide range of services such as transport, transport fares or vouchers and tools for dismantling transitional shelters. Beneficiaries of a transitional shelter programme willing to return or relocate may be unable to carry with them the most valuable parts and materials of their transitional shelters (e.g. timber beams and CGI roof sheeting) due to a lack of appropriate means of transportation or because they may not be able to afford transportation costs.

**3.8.8**



**INFRASTRUCTURE AND SETTLEMENT PLANNING SUPPORT**

**Definition**

269. Infrastructure and settlement planning support should be provided to improve the services offered to the community, in terms of safety of the transitional settlement and accessibility to essential communal facilities (such as health clinics/hospitals, schools, religious buildings, markets etc.). » 4.2

**When appropriate**

270. To speed up the recovery process, support for infrastructure and settlement planning will be required during the response and should be integrated into the shelter programme plan/strategy.

271. Repair and construction of major infrastructure such as roads, bridges, transportation systems, water supply, treatment and distribution systems, telecommunications etc. will require inter-sectoral coordination (e.g. with the WASH, telecommunications, logistics sectors) and integrated programming.

1

definition of TS  
10 TS principles  
5 characteristics  
when not to use TS

definition

2

decision-making tool

tool

3

coordination  
programme plan  
assessment  
beneficiaries  
labour  
materials  
procurement  
support  
quality assurance

programme

4

community  
site selection  
site planning  
land tenure  
handover

site

5

socio-cultural  
minimise risk  
climatic design  
materials  
construction

design

resources

**Definition**

272. Environmental damage resulting from disasters, whether caused by natural hazards or conflicts, may have serious impacts on human health and the local availability of natural resources. Disasters can lead to significant environmental risks and damages. In addition, demand for materials after disasters may cause severe environmental degradation. Acknowledgement of these issues should be made within the transitional shelter programme.

**When  
appropriate**

273. In order to reverse damages to the environment following the disaster and minimise the environmental impact of transitional shelter interventions, rapid environmental assessments should be conducted as soon as possible to identify and evaluate the main environmental impacts generated by the disaster and provide guidance on the major environmental concerns to be included in the programme plan.

274. This section presented the nine support methods that may be used according to the needs of the affected population. These options have to be continuously evaluated and monitored as described in the next section.

## 3.9

# QUALITY ASSURANCE

275. A transitional shelter approach supports displaced populations over the period of securing land tenure and reconstruction. This process may take a number of years and therefore it is essential that transitional shelters are both fit for purpose and compliant with government policy. The design solution should:

- ▶ be structurally sound;
- ▶ provide adequate protection from the environment;
- ▶ offer a level of safety and security;
- ▶ provide access to water and sanitation needs;
- ▶ support livelihoods; and
- ▶ achieve agreed standards.

📖 UNHCR, 2005. *Transitional Shelter Quality, Standards And Upgrading Guidelines*, p.1.

276. The following section offers guidance on quality assurance through quality control processes, supervision and technical expertise, capacity building, monitoring and evaluation, community considerations and technical evaluation.

### 3.9.1

## QUALITY CONTROL

**Quality control in the humanitarian context**

277. In the humanitarian context quality control is primarily necessary to ensure the durability of the support to beneficiaries. Secondly, but no less importantly, it is vital to demonstrate to donors the ability to maintain high quality standards in order to ensure funding.

**Standard quality control processes**

278. Many organisations have specific quality control procedures. Transitional shelter programmes and projects managers should be fully aware of such procedures and implement them systematically.

**Identification of crucial factors**

279. It is important to identify crucial factors influencing quality in order to avoid quality control becoming a burden for the transitional shelter project.

**Quality control of material specifications**

280. One of the main issues concerning quality control in the context of transitional shelter is to ensure the accuracy of material specifications used to source NFIs. It is necessary to verify all specifications before the procurement process starts in order to ensure that appropriate NFIs are distributed.

1

definition of TS

10 TS principles

5 characteristics

when not to use TS

SWOT

2

decision-making tool

3

coordination

programme plan

assessment

beneficiaries

labour

materials

procurement

support

quality assurance

4

site

community

site selection

site planning

land tenure

handover

5

design

socio-cultural

minimise risk

climatic design

materials

construction

resources



### *Tip: Obtain material samples*

Obtain material samples from possible suppliers during the tender process which can later be compared with the delivered materials to ensure the quality

#### **Quality control of delivered goods**

281. Deliveries should be closely inspected, with damages and defects to goods documented before the shipment is formally accepted. Photos of the goods should be taken for documentation purposes and delivered goods should only be accepted when specifications are assured.



### *Tip: Assess value*

Assessment of the monetary value of damages and/or losses should be undertaken alongside documentation of associated transport costs.

#### **Quality control of contractors**

282. Before issuing a contract to a supplier, capacities and skill levels should be matched to the specifications indicated. It may be appropriate to ask for references in tendering documents which can be checked later. It is also common to include the material specifications in the annex of the purchase contract.

## **3.9.2**



## **SUPERVISION AND TECHNICAL EXPERTISE**

#### **Technical support**

283. The success of a transitional shelter programme is influenced by the level and timeliness of technical support and quality assurance provided during the implementation process. Especially in large responses and where self-help and community labour are selected; the implementing agency should have enough technical surge capacity to ensure that shelters are constructed in compliance with minimum standards including hazard-proof measures.

#### **Range of expertise**

284. Technical experts, provided by national and/or international humanitarian agencies or the private sector, may be required to:

- ▶ supervise construction works;
- ▶ conduct technical inspections, building damage and risk assessments, monitoring and evaluation of transitional shelter programmes; and
- ▶ provide technical training of skilled and unskilled labour (beneficiaries, masons, master craftspeople, small/local contractors), small scale construction companies and local implementing partners.

### 3.9.3



## CAPACITY BUILDING

#### The aim of capacity building

285. Capacity building encourages long-term investment. It offers opportunities for stakeholders to increase their ability to respond individually and collectively, but also to interact and consider common challenges and tools, such as developing and implementing building standards and codes. An integrated capacity building programme should be included wherever possible and deemed necessary, involving workshops, training, skills development, secondments and resource and information services.

#### Capacity building target groups

286. Appropriate supervision and quality control should be promoted by capacity building activities with the support and contribution of construction industries and institutions. A capacity building programme should be planned on the basis of the outcomes of needs and capacity assessments conducted in collaboration with the affected population, local authorities, national aid agencies and grassroots organisations. » 3.4

#### When to use capacity building

287. Capacity building should be considered whenever assessments indicate that the affected population does not have the capacity to implement transitional settlement or reconstruction projects itself. For example, leaflets and posters can be distributed to teach good practice in risk management. Community awareness of “building back better” is essential to cope with and prepare for the effects of a future disaster.

#### Capacity building as a continuous process

288. Training and workshops should not be considered as isolated events to impart knowledge, but rather as continuous processes to identify and tackle common challenges and to enable collaboration among participating stakeholders. Clear objectives and indicators should be agreed that define and measure the impact of reconstruction, rather than the number of persons trained.

#### Capacity building activities

289. Capacity building activities may include one or more of the following:
- ▶ training regarding hazard-proof construction techniques, project management, site supervision and quality control;
  - ▶ consultation and information-sharing workshops, which use participatory techniques and involve representatives of different community groups within the affected population and public authorities; and
  - ▶ volunteer teams, secondments, resource and information services to support with additional capacity.

1

definition of TS  
10 TS principles  
5 characteristics  
when not to use TS  
SWOT

definition

2

decision-making tool

tool

3

coordination  
programme plan  
assessment  
beneficiaries  
labour  
materials  
procurement  
support  
quality assurance

programme

4

community  
site selection  
site planning  
land tenure  
handover

site

5

socio-cultural  
minimise risk  
climatic design  
materials  
construction

design

resources



### Case study: Earthquake Aceh, 2004—Safe housing programme (DEC member agency)

Following the earthquake in 2004 and the resulting tsunami a training programme was implemented to raise awareness of the risk of earthquakes in order to offer insight to the community. Twelve key principles of safe building practices were presented using posters, each supported by additional information provided in further training modules. A pilot project using local materials was implemented in each village to demonstrate safe building construction techniques, processes and offer skills training to local labourers and craftsmen and women. Along with this workshops were set up to involve and engage the entire community. 📖 DEC, 2010. *Lessons from Aceh*, p.64.

## 3.9.4 MONITORING AND EVALUATION

### Introduction

290. Maintaining an accurate understanding of the progress and impacts of a transitional shelter programme is required to support beneficiary and donor accountability, correcting possible deficiencies and drawing conclusions with regard to how future responses may be informed by good practice. Developing a successful monitoring and evaluation process supports these objectives. The following information presents an overview of monitoring and evaluation and explains how they correlate with other aspects of programme design.

### Monitoring and evaluation as part of the assessment cycle

291. Monitoring and evaluation are closely connected to the programme assessment which should be a continuous process. » 3.4 This is particularly relevant when situations are unstable or rapidly changing such as in conflict-affected areas subject to a natural disaster. After detailed information has been gathered through in-depth assessments it can be used to monitor selected indicators. Plans can then be revised in order to make sure project objectives are achieved. At the end of the programme, information gathered can be used to evaluate the overall programme performance and improve future transitional shelter responses.



### Case study: Kenya conflict displaced, 2008—The need for a continual process

Following the Kenyan election crisis, between 125,000–250,000 people were accommodated in camps and associated settlements. By the end of 2008 the Kenyan Government stated this number had reduced to 10,000, despite media and civil society sources claiming 80,000–100,000 to be more accurate. As a result, an alleged \$2.5million has been diverted away from “Operation Return Home”. This has had

a number of consequences, for example in order to meet reduced operations targets for monthly returns water supplies in a number of camps were cut off. The need for a continual monitoring and assessment process alongside the importance of independent evaluation is clear. The programme has thus been criticised for violating the “Guiding Principles on Internal Displacement”.

UN-HABITAT and IFRC, 2010. *Shelter Projects 2009*, p.20.

**Goals of monitoring and evaluation**

292. The process of humanitarian monitoring and evaluation should combine a series of indicators and methods, in order to verify through comparison, or triangulate, the results and conclusions. Seven considerations and criteria set out by the Development Assistance Committee (DAC) are included as an example in the Table 3.6.

**Table 3.6**  
DAC criteria for monitoring and evaluation

**Table 3.6 DAC criteria for monitoring and evaluation**

Criterion	Questions for a transitional shelter programme or project manager
<b>Relevance/ appropriateness</b>	Does the project address the needs and priorities of the affected population?  Are the activities tailored to increased ownership, cost-effectiveness and accountability?
<b>Connectedness</b>	Are the short-term activities undertaken in a context that ensures long-term issues are taken into account?
<b>Coherence</b>	Are the monitoring and evaluation strategies in line with the larger scale evaluation?  Are security, development, trade and military policies considered alongside humanitarian policies?
<b>Coverage</b>	Does the programme address major groups within the affected population?
<b>Efficiency</b>	Are appropriate capacities and relevant resources being utilised?  Has the most efficient programme approach been designed to achieve both quantitative and qualitative outputs?
<b>Effectiveness</b>	Are the projected outputs being met?
<b>Impact</b>	Are the common goals being achieved?  What are the wider effects of the programme with regard to social, economic, technical and environmental concerns?  Will the impact last?

ALNAP, 2006. *Evaluating Humanitarian Action Using The OECD—DAC Criteria*, p.21–22.

1

definition of TS  
10 TS principles  
5 characteristics  
when not to use TS  
SWOT

definition

2

decision-making tool

tool

3

coordination  
programme plan  
assessment  
beneficiaries  
labour  
materials  
procurement  
support  
quality assurance

programme

4

community  
site selection  
site planning  
land tenure  
handover

site

5

socio-cultural  
minimise risk  
climatic design  
materials  
construction

design

resources



**Tip: Highly relevant indicator**

One of the most relevant indicators regarding transitional shelter programmes is the percentage of selected beneficiaries who still inhabit their shelters after two to three months. These figures provide information on a number of facts, i.e. extreme poverty leading to material resell or sub-letting; movement due to security reasons; economic or land tenure issues; absence of essential service such as water and sanitation.

**Purpose of monitoring**

293. By monitoring benchmarked indicators it is possible to assess if activities are producing desired results, if these results are meeting the projected purpose and if projected risks affect the programme. The purpose of monitoring is to track:

- ▶ physical and financial progress;
- ▶ ongoing priorities and allocation of resources;
- ▶ support of project management through monitoring of staff and internal procedures;
- ▶ equitable distribution of benefits among affected groups;
- ▶ acceptance of the project and relevance to the affected population; and
- ▶ implementation problems and constraints.

**How monitoring is carried out**

294. Monitoring plans should be linked to the logical framework approach in which crucial indicators for project success are identified. »3.2.3 Monitoring plans should set benchmarks for these indicators and record whether or not they occur according to the given timeframe.

295. In a transitional shelter response, monitoring should be carried out by all individuals working on the project. Information on all activities should be processed and compiled in reports. Minor changes by project staff should be documented for monitoring purposes. Since it is important to keep the process transparent, information should be shared and discussed with all implementing agencies, donors and beneficiaries.

**Purpose of evaluation**

296. The purpose of evaluation is to:

- ▶ create ongoing hazard mitigation risk management procedures;
- ▶ assess an on-going or completed programme, project or policy;
- ▶ determine the relevance and fulfilment of objectives by evaluating monitored indicators;
- ▶ establish efficiency, effectiveness, impact and sustainability;
- ▶ improve the design of future transitional shelter programmes; and



- ▶ be accountable to beneficiaries of the programme as well as donors.

📖 UN, 2010. *SAD*, p.76–77.

**How evaluation is carried out**

297. Evaluations should be conducted at the end of the project and at intervals along an agreed timescale. Evaluations should assess the information gathered through the monitoring process. When monitoring shows that certain indicators have not been met as intended, the evaluation should indicate possible revisions to the programme plans.

### 3.9.5

## COMMUNITY CONSIDERATIONS

**Qualitative and quantitative approach**

298. All too often monitoring and evaluation strategies deal with base facts and figures. Successful strategies select methods suited to a specific context combining both quantitative and qualitative data as appropriate. The affected population are the most suitable group to give an in-depth commentary on how the humanitarian response has affected their lives. Monitoring and evaluation strategies should therefore include such qualitative approaches as open-ended listening and individual feedback opportunities. 📖 The Sphere Project, 2011. *The Sphere Handbook*, p.69–70.

**Level of community participation in the process**

299. The entire monitoring and evaluation process should be as inclusive as possible, particularly with regard to community participation. Monitoring and evaluation strategies undertaken by the affected population contribute to effective communication, increased accountability, enhanced transparency and ownership of information. 📖 The Sphere Project, 2011. *The Sphere Handbook*, p.70.

**Local cultural practices**

300. It is important to consider local cultural practices at an early stage in monitoring and evaluation. For example, minority groups or women may need to be consulted separately and it is therefore useful to involve both men and women in the process of collecting information from the affected population. Appropriate individuals can do so in a culturally acceptable manner and can use local language and dialect to gather accurate feedback. 📖 UN, 2010. *SAD*, p.69.

**Culturally appropriate materials**

301. Consideration should be made to prioritise culturally sensitive materials and technologies. Materials should be chosen to allow for local tools and skills, whilst achieving a level of sustainability and longevity. The monitoring and evaluation process should assess whether this has been achieved and whether this issue should be re-addressed in light of changing situations.

1

definition

definition of TS  
10 TS principles  
5 characteristics  
when not to use TS  
SWOT

2

tool

decision-making tool

3

programme

coordination  
programme plan  
assessment  
beneficiaries  
labour  
materials  
procurement  
support  
quality assurance

4

site

community  
site selection  
site planning  
land tenure  
handover

5

design

socio-cultural  
minimise risk  
climatic design  
materials  
construction

resources

## 3.9.6 TECHNICAL EVALUATION

### Independent evaluation

302. Typically evaluations should be undertaken by independent, external bodies to avoid bias. In some circumstances it may be permissible for internal, associated professionals to evaluate a programme if objectivity can be preserved. Such individuals or groups should not be directly related to the programme.

### Relevant expertise

303. Early attention must be given to engage relevant professionals in order to address the specific nature of transitional shelters. A multi-disciplinary team should be formed to undertake the monitoring and evaluation process. This should involve people of different genders and ethnicities as well as local expertise and capacities from different disciplines. Those with previous experience of disasters within the region and with local knowledge will be invaluable to the process. Safety, health, livelihoods and recovery expertise is as important as planning, design, engineering and construction.

### Disaster risk reduction

304. Disaster risk reduction is a continuous process which assesses the vulnerability of people, buildings and infrastructure and aims to ensure risks are not restored.

305. In terms of the built environment for example, disaster risk reduction measures include:

- ▶ managing and maintaining assets;
- ▶ strengthening vulnerable structures;
- ▶ preventing or re-examining building activity in high-risk areas; and
- ▶ ensuring building regulations are enforced.

 Max Lock Centre, 2009. *The Built Environment Professions in Disaster Risk Reduction and Response*, p.18.

306. Changes to building codes or standards as a result of the disaster should be applied in consultation with the affected population and all relevant authorities.

307. It is not always possible to eliminate all risks and the progress of various activities such as assessment of needs, capacities and vulnerability may not happen at the same pace. It is important therefore to achieve a high level of coordination among all stakeholders to ensure an effective disaster risk reduction strategy.



### **Case study: Haiti earthquake displaced, 2010—Disaster risk reduction**

Following the earthquake in January 2010 the Shelter Sector Response Plan was implemented to support the Haitian Government in meeting the transitional shelter and emergency

needs of the affected population. Disaster risk reduction in particular was well integrated into the strategy. Anticipation of the hurricane season included such measures as early warning systems, improvements to latrines and adaptation of drainage, evacuation routes and basic first aid training for the community. UN, 2010. *SAD*, p.61–62.

308. This section offers guidance on quality assurance through quality control processes, supervision and technical expertise, capacity building, monitoring and evaluation, community considerations and technical evaluation, in order to support beneficiaries and achieve donor expectations. These quality control processes should be considered regarding site selection and planning, to ensure an appropriate response. These two issues are addressed in the next chapter, along with supporting a community, land tenure and handover issues.

309. To summarise Chapter 3, Table 3.7 offers an overview of common problems and issues for consideration for transitional shelter project managers.

**Table 3.7 Key considerations for transitional shelter**

**Donors and funding**

**Table 3.7 Key considerations for transitional shelter**

Potential problem	Solutions/mitigating activities
<b>PLANNING STAGE</b>	
Risk of donor-driven rather than demand-driven responses.	Communicate with donors regularly and in detail to provide technical evidence as to why a particular project type would be appropriate.
Some donors may be used to supplying funds in three "phases": emergency, early recovery and reconstruction. This may not be applicable for a transitional shelter programme.	Consider targeting different donors for different stages of the project—"emergency relief" donors for the initial stages and "reconstruction" donors for the later stages.  Ensure that the transitional shelter concept is fully explained to donors so that the reasons behind funding requests are understood.
Donor requirements may not appear feasible as more detailed information becomes available. For example, a funding plan may specify that money be spent by certain dates, which are later revealed to be unreasonable due to harvest times or adverse climatic conditions.	Communicate with donors regularly and in detail to provide up-to-date information on progress and constraints.
Very limited funding.	Decide between providing an equal, low level assistance to the entire affected population or identifying only the most vulnerable households for direct assistance and indirectly assisting the wider population through the dissemination of DRR, best practice, site selection and preparation, and design and construction.

- 1 definition
- 10 TS principles
- 5 characteristics
- when not to use TS
- SWOT
- 2 tool
- decision-making tool
- 3 programme
- coordination
- programme plan
- assessment
- beneficiaries
- labour
- materials
- procurement
- support
- quality assurance
- 4 site
- community
- site selection
- site planning
- land tenure
- handover
- 5 design
- socio-cultural
- minimise risk
- climatic design
- materials
- construction
- resources

	Potential problem	Solutions/mitigating activities
	<b>PLANNING STAGE</b> (continued)	
<b>Setting up</b>	Agency registration in-country can be time consuming.	Meet with the relevant authorities as soon as possible on arrival in-country, and follow up progress as necessary.  The UN is registered in all countries. Consider engaging them to help if necessary.
	Setting up national bank accounts to enable the transfer of money into the country can take time, create cash flow issues and delay project start up.	If possible, take sufficient initial funds.  Initial rapid assessment should include a logistics investigation of local banking procedures.  Set up a bank account as early as possible and investigate e-banking, transferring funds via SMS etc.
	The process of locating, securing and finalising contracts for a new office can cause delays in project start up.	Consider transferring staff from other agency offices who are already familiar with agency operation (e.g. the regional office/central hub).
<b>Personnel</b>	Accurate estimation of personnel requirements can be difficult in the early stages when information is limited or incomplete.	Use planning tools such as a logical framework approach and scope of works to make initial assumptions of personnel requirements and modify estimates as more information becomes available.
	High competition for local staff with appropriate skills and experience, for example, those with skills in: construction management, financial management or community mobilisation.	A fair and transparent recruitment process is important for attracting good staff.  International recruitment may be appropriate, especially in the early stages. A selection of national/local staff may increase and replace international staff over time.  Ensure that particular skills are genuinely required. For example, it may be appropriate to hire site managers and builders to carry out quality control checks in the place of engineers, if appropriately supervised.
<b>Local partners</b>	Rapid identification of credible local implementing partners can be difficult.	Check potential implementing partners thoroughly. Checks may include: review of financial records; validation of stated number of staff members and their qualifications, and site visits to other projects undertaken by the agency.  Be aware of the capacity of local partners, and the MoUs that they hold with other organisations.  It should be ensured that implementing partners are selected on the basis of a transparent bidding procedure.
<b>Strategic planning</b>	Circumstances of the beneficiaries change before construction has been completed. For example, beneficiaries may want or need to relocate earlier than anticipated.	Contingency planning should be built into programme and project plans so that a pre-defined strategy can be put into action in the case of a change of circumstances. For the example where beneficiaries may wish to relocate sooner than anticipated, it should be possible for them to take shelter materials with them to their new location.

Potential problem	Solutions/mitigating activities
<b>PLANNING STAGE</b> <i>(continued)</i>	
The identification of critical path activities can be difficult in projects which are new in type or scale to the implementing agency.	A pilot programme may help to identify key activities.
Natural hazards or problematic weather conditions delay construction.	Predictable weather patterns should be factored into the schedule of operations. Contingency planning should consider the effects of adverse climate and weather conditions on project progress. Risk assessments should be undertaken to identify potential natural hazards and adverse weather conditions, and contingency plans should be defined during the planning stage.
Mitigating risks requires highly engineered structures with associated higher costs.	It may be appropriate to design shelters to be hazard resilient, rather than completely hazard proof. As a minimum, transitional shelters should remain structurally sound for long enough for the inhabitants to evacuate the shelter without risk of injury or death due to elements of the shelter falling or collapsing.
Appropriate standards should be formed rapidly so that they can be used to inform shelter design.	Consider using the transitional shelter decision-making tool as an aide-mémoire to cover all points. Identify any existing local or national building standards which may need to be included.
Water and sanitation, social, health and education facilities are not included in programme plans due to lack of budget or expertise.	Coordinate with other agencies and sectors whose mandates cover these issues directly.
<b>IMPLEMENTATION</b>	
Inflation, changing exchange rates and fluctuating materials costs can make accurate cost estimates difficult.	Contingency planning should be built into donor proposals, to ensure that programmes can be adapted to actual inflation and exchange rates. Plans may include additional or fewer beneficiaries, or alterations to shelter designs.
Financial tracking in a large scale project over a wide geographical area can be difficult.	Use standard templates for recording transactions. Consider splitting financial tracking responsibilities into smaller areas to make accurate tracking more feasible.
Time consuming reporting and accountability frameworks cause delays in decision making.	Use simple standard templates for reporting.

**Site selection/  
preparation and  
shelter design/  
construction**

**Holistic  
response**

**Donors and  
funding**

1

definition

definition of TS  
10 TS principles  
5 characteristics  
when not to use TS

SWOT

2

tool

decision-making tool

3

programme

coordination  
programme plan  
assessment  
beneficiaries  
labour  
materials  
procurement  
support  
quality assurance

4

site

community  
site selection  
site planning  
land tenure  
handover

5

design

socio-cultural  
minimise risk  
climatic design  
materials  
construction

resources

Potential problem	Solutions/mitigating activities
<b>IMPLEMENTATION</b> <i>(continued)</i>	
<p><b>Personnel</b></p> <p>High turnover of staff makes accountability difficult and can put stress on longer term staff.</p>	<p>ToRs for positions with high turnover rates should be well defined, including details of all roles and responsibilities, to ensure that the position is well understood by incoming staff.</p> <p>Ensure that records are well kept, ideally on standard templates.</p> <p>Where possible, allow a handover period between incoming and outgoing staff.</p> <p>Ensure that new team members are given full orientation and induction to the job.</p>
<p><b>Local partners</b></p> <p>Local partners are new to working with humanitarian agencies or on this type of shelter project.</p> <hr/> <p>Monitoring local partners and ensuring the work of local partners is of sufficient quality can take time and resources.</p>	<p>Communicate regularly and clearly with implementing partners to ensure that they fully understand what is required of them and the consequences of not completing work on time or to quality are known. Monitoring and reporting systems should also be clearly communicated.</p> <p>Capacity building and training sessions for local partners may be appropriate.</p> <p>Ensure that budget is allocated for capacity building, monitoring and quality control of implementing partners.</p> <hr/> <p>Use a clearly defined system to monitor the work of the implementing partners, for example, organise field teams to regularly report back to the hub. Consider undertaking random spot checks.</p> <p>Identify the most crucial site selection/preparation and building design/construction indicators to reduce time required for quality control checks.</p> <p>Ensure that local partners have appropriate tools, materials, knowledge and skills prior to commencing work.</p>
<p><b>Procurement</b></p> <p>Damaged infrastructure makes transport of materials and personnel to site difficult.</p> <hr/> <p>Materials arrive on site damaged or not as advertised/requested.</p>	<p>Procure materials locally where possible to reduce transportation requirements.</p> <p>Where materials need to be transported to site, materials should be selected and packs designed such that they can be transported by hand or by other suitable transport means.</p> <p>Coordinate with the government and with other sectors where major repair work is required.</p> <hr/> <p>Check materials as early as possible, ideally at ports or airports where they have been sourced internationally, to avoid unnecessary transport costs if they are damaged or not as requested.</p> <p>Take care when specifying materials.</p>

	Potential problem	Solutions/mitigating activities	
	<b>IMPLEMENTATION</b> <i>(continued)</i>		<b>1</b>
<b>Beneficiaries</b>	Beneficiaries unwilling to accept advice on new designs or building techniques.	Prioritise the use of local and traditional building techniques where possible. Implement a strong social mobilisation programme, ideally hiring staff from within the affected communities.	definition of TS 10 TS principles 5 characteristics when not to use TS SWOT
	<b>HANDOVER</b>		<b>2</b>
<b>Handover</b>	Beneficiaries have unrealistic expectations about the shelters or project timescale of are unhappy with the design or build quality.	Implement a coordinated strategy for communication with the affected community. Establish a grievance redress system and humanitarian helpline to assist beneficiaries in dealing with land/human rights issues and ensure that realistic expectations are met. Implement a strong social mobilisation programme, ideally hiring staff from within the affected communities.	decision-making tool
			<b>3</b>
			coordination programme plan assessment beneficiaries labour materials procurement support quality assurance
			<b>4</b>
			community site selection site planning land tenure handover
			<b>5</b>
			socio-cultural minimise risk climatic design materials construction

definition

tool

programme

site

design

resources



# 4 COMMUNITY SITE SELECTION AND PLANNING

## Chapter contents

---

<b>4.1</b>	<b>SUPPORTING A COMMUNITY</b>	
4.1.1	Identifying community priorities, capacities and challenges	111
<b>4.2</b>	<b>SITE SELECTION</b>	
4.2.1	Site appropriateness	114
4.2.2	Site safety	117
<b>4.3</b>	<b>SITE PLANNING AND COMMUNAL INFRASTRUCTURE</b>	
4.3.1	Community involvement in planning sites and infrastructure	123
4.3.2	Site multi-hazard risk mapping and mitigation	123
4.3.3	Transitional shelter settlement layouts and contour planning	124
4.3.4	Site access	125
4.3.5	Communal infrastructure and services	126
<b>4.4</b>	<b>LAND TENURE</b>	
4.4.1	The importance of land and land tenure	129
4.4.2	Tenure security	129
4.4.3	The impact of a disaster on land	130
4.4.4	Land and the transitional shelter approach	130
4.4.5	Limits of transitional shelter	131
4.4.6	Legal frameworks and informal processes	132
4.4.7	Using an incremental approach to increase security	132
4.4.8	Land ownership identification methods	133
4.4.9	Multi-party agreements	133
<b>4.5</b>	<b>HANDOVER</b>	
4.5.1	Handover considerations	135



## Introduction

1. Transitional shelter programmes influence the way in which communities rebuild and recover. Programmes must avoid only supporting individual shelters and instead should work with each community in the affected population, as well as groups within each community, in order to uphold their collective priorities. The selection, planning and development of sites, communal infrastructure and services, as well as the shelters themselves each impact upon livelihoods, reconstruction and early recovery. Such support empowers communities and builds capacities and self-sufficiency.

2. In Chapter 4, guidance is offered on supporting the community and community groups in site selection, site planning and communal infrastructure, such as schools and roads.

3. In Chapter 5, guidance is offered on supporting the community and community groups in designing and implementing the transitional shelter process, including selecting materials.

## Engaging the participation of the community

4. Many of the methods of engaging the participation of the community and community groups are the same for site selection, planning and infrastructure as they are for the transitional shelter process. For example, a committee may be formed to undertake hazard mapping and plan the site and then later go on to consider the positioning of surface water drainage around the shelters.

## The importance of community consultation

5. Throughout these guidelines, it is recognised that a balance must be achieved between action and consultation, especially in the life-saving period immediately following a conflict or disaster. Consultation based upon samples or profiles should be undertaken even in a pressingly urgent situation, for example when an agreement is reached at sector coordination level to undertake a common course of action. As with transitional shelter, consultation is an incremental process, and initial community events and structures should be invested in and built upon throughout the response.

1

definition of TS  
10 TS principles  
5 characteristics  
when not to use TS  
SWOT

definition

2

decision-making tool

tool

3

coordination  
programme plan  
assessment  
beneficiaries  
labour  
materials  
procurement  
support  
quality assurance

programme

4

community  
site selection  
site planning  
land tenure  
handover

site

5

socio-cultural  
minimise risk  
climatic design  
materials  
construction

design

resources



## 4.1 SUPPORTING A COMMUNITY

### Community recovery through engagement and support

6. In order to offer support, governments and humanitarian stakeholders must develop and maintain an understanding of the priorities, capacities and challenges of each community. This involves undertaking projects for communal infrastructure and services such as for the WASH sector and schools; and select, plan and develop sites for transitional shelters. Livelihoods and reconstruction must also be taken into consideration, within the context of early recovery.

### 4.1.1

## IDENTIFYING COMMUNITY PRIORITIES, CAPACITIES AND CHALLENGES

### Engaging community leaders and committees

7. From the first assistance offered in the transitional shelter process, whether it is cash or material distribution, community leaders and representative members of groups within each community should be engaged in agreeing the type of assistance and its delivery.

### Representation structures

8. This relationship is built upon throughout the duration of the transitional shelter programme, also supporting parallel reconstruction and other sector and cross-cutting interventions. The traditional representation structures for each community should be respected; however, communities should be encouraged to review these structures in their current context, to see if they should be adapted. For example, new community committees and consultation groups may be formed to consider new opportunities and challenges in moving rubble or siting a school.

### Community participation through workshops

9. Holding workshops with community groups may offer a valuable way of engaging different viewpoints. They may be helpful to support community leaders and committees in making decisions about detailed activities that require broad debate or consensus. Participatory approaches such as the participatory approach for safe shelter awareness (PASSA) may develop local capacity to reduce shelter related risk by raising awareness and developing skills in joint analysis, learning and decision-making at community level. More information can be found in IFRC PASSA »4.3.2.

### The aim of workshops

10. Workshops may be single events for individual groups, but comparing results from a collection of workshops can be useful. Workshops can be valuable in building consensus and understanding of common opportunities and challenges, as well as offering monitoring and accountability. For example,

workshops may be used to plan and implement community risk mapping.



4.1 Safe building workshop, Pakistan  Usman Ghani/IOM Pakistan.

**Livelihoods support**

11. Effort should be made to support the livelihoods of the affected population, again to increase the self-sufficiency and capacity necessary for early recovery. Consultations and workshops may be used to identify the range of livelihood activities traditionally undertaken by the affected population, as well as appropriate assistance methods. » 3.8 The transitional shelter approach should support and create opportunities for livelihoods, based on assessments: for example, if the displaced population comprises predominantly farmers, the site-selection process should concentrate on identifying appropriate low-density, dispersed, small sites, in areas close to their agricultural land. A community project may also be initiated to repair a road connecting the community to local markets.

**The influence of seasons**

12. The season influences the ability of both the displaced and local populations to provide for their own needs, but also their availability to participate in self-help transitional shelter activities. » 3.5.1 The climate may also affect the capacity, decisions and actions taken, with an impact on protection, security and health. For example, displaced farmers may not want to move too far from their land before the harvest. This would affect their protection, as well as the choice of transitional shelter options supported by local governments and aid organisations.  University of Cambridge, 2005. *TSDP*.

**Cultural sensitivity**

13. The culture of the community must be reflected throughout transitional shelter programmes, such as when planning a transitional shelter site. Cultural beliefs and activities are not homogenous and cultures are not static; they are continually being renewed and reshaped. Cultural change is shaped by many factors, particularly by conflict, disasters and displacement

1

definition of TS  
10 TS principles  
5 characteristics  
when not to use TS  
SWOT

definition

2

decision-making tool

tool

3

coordination  
programme plan  
assessment  
beneficiaries  
labour  
materials  
procurement  
support  
quality assurance

programme

4

community  
site selection  
site planning  
land tenure  
handover

site

5

socio-cultural  
minimise risk  
climatic design  
materials  
construction

design

resources

📖 UNHCR, 2007. *Handbook for Emergencies*. Change also results from deliberate efforts to influence values through revisions of law or government policy, for example in attitudes towards hazards and introducing safer construction practices.

**Cultural sensitivity in site planning**

14. Cultural sensitivity should be central to site planning, integrating local habits and traditions, for example maintaining pre-existing planning and building patterns, in order to help preserve the cultural identity and sense of ownership of the affected community.

**Protection and gender considerations**

15. Following a conflict or disaster, normal community structures may be disrupted and the changes in demographic proportions may alter daily routines of the affected population. This could also have a negative effect on traditional mechanisms for the protection and assistance of persons with specific needs.

**Changes in social composition**

16. Change in social composition of an affected population requires attention when planning and implementing a transitional shelter programme and may include:

- ▶ increased numbers of male or female-headed households;
- ▶ large numbers of unaccompanied children;
- ▶ reduced number of able-bodied men and women; and
- ▶ disruption of the extended family, with its role as social carer.

**Considering specific needs**

17. The specific needs of people must be taken into account in site planning. It may be difficult to reach these people if they do not form part of the traditional leadership structure of the community. In such cases, the needs and resource assessment should obtain a complete overview of all concerned through age, gender and diversity mainstreaming.

**Vulnerable individuals within a community**

18. Similarly, vulnerable individuals and those with special needs may be difficult to reach and are likely to require more attention. Conflicts and disasters result in injury and disability, however, the community will already have members who are disabled and elderly who require different support, both in programme design and implementation. For example, someone using a wheelchair may require paving to their door and a wider doorway; and they will also require labour assistance to build their shelter. Adapted from 📖 UNHCR, 2007. *Handbook for Emergencies*.

## 4.2 SITE SELECTION

### The importance of site selection in all responses

19. Site selection is relevant to both displaced and non-displaced populations in both urban and rural settings. Even when a single transitional shelter is sited on the land of an affected family, it can still be vulnerable to further hazards and can impact reconstruction and recovery.

20. Transitional shelters for community groups are often found near original homes but not on the land itself, due to considerations such as rubble clearance and reconstructing multi-family dwellings such as apartments. Site selection in this context must be understood as a process and not a single event, as families may relocate their transitional shelter to their land, once they are able to do so.

21. Site selection is an important activity that can result in the success or failure of a transitional shelter programme. Poor site selection can threaten the safety of the beneficiaries, the sustainability of livelihoods and essential environmental resources. In contrast, good site selection may encourage social integration and enhance sustainability.

### Including all relevant stakeholders

22. Site selection requires broad consultations with all stakeholders concerned with the selection, planning, development and use of the site. It should include representatives from the displaced and host populations, government and humanitarian stakeholders, as well as the advice of local and international sector specialists, such as civil and water engineers, seismologists, geologists, hydrologists and cadastral surveyors. In terms of coordination, site selection is an inter-sector or inter-cluster activity, also requiring cross-cutting input.

### 4.2.1 SITE APPROPRIATENESS

#### Selection criteria

23. Sites should be assessed using criteria specific to the response, but ensuring that they are:

- ▶ safe, considering multiple probable hazards such as flooding;
- ▶ appropriate to the displaced community with respect to local culture and livelihoods;
- ▶ capable of providing key sustainable resources, such as a water supply; and
- ▶ legal, in terms of zoning and planning as well as regarding land owners and customary users.

1

definition of TS  
10 TS principles  
5 characteristics  
when not to use TS  
SWOT

definition

2

decision-making tool

tool

3

coordination  
programme plan  
assessment  
beneficiaries  
labour  
materials  
procurement  
support  
quality assurance

programme

4

community  
site selection  
site planning  
land tenure  
handover

site

5

socio-cultural  
minimise risk  
climatic design  
materials  
construction

design

resources

#### Site safety

24. Site safety is the primary concern and is considered in detail in the next section. »4.2.2 When developing the criteria for the selection of an appropriate site, the following additional factors should be considered.



#### **Attention: Assess changed hazards and risks**

Following a natural disaster, there may have been changes to terrain and water courses. As such, vulnerability of certain locations (for example to flooding or landslides) may not be the same as before the disaster occurred. There may be a need for a community based re-mapping, as pre-disaster hazard zoning knowledge may no longer be entirely reliable.

#### Early recovery objective

25. When selecting a site, the final objective of the transitional shelter programme should be considered. If a resettlement site turns into permanent settlements, social, physical, political and legal appropriateness will need to be taken into account. The possibility of resettlement should be carefully assessed. Beneficiaries may not want to be relocated if they are not involved in the consultation and site selection process. This may force them to occupy informal and illegal sites, or to move back to their previous location where they may be further exposed to risks and hazards.

#### Social and cultural appropriateness

26. The location should be agreed upon in consultation with the beneficiaries through a participatory process. A bottom-up approach, considering the characteristics and needs of the individuals from the beginning, will ensure that the selected sites are appropriate in terms of cultural and social acceptability. Consideration should also be given as to whether ethnic tensions between neighbouring settlements may arise.

#### Local livelihood support

27. Transitional shelters should be constructed as close as it is safely possible to the beneficiaries' place of origin or, where beneficiaries are to be permanently relocated. Minimising the duration of their displacement and the physical distance from their place of origin enables people to recover social connections and livelihoods as quickly as possible. If sited too far from local markets and their livelihoods, the displaced community may reject the transitional shelter support and the sites may be abandoned.

#### Accessibility

28. The proximity to main roads and accessibility of essential communal services, facilities and natural resources for daily use should be considered when selecting the site. There should be appropriate access to and from the site for emergency services to get sufficiently close to shelters, as well as for the supply of building materials for incremental upgrading and any distributions.



## Topography

29. When assessing sites, several topographical features should be considered:

- ▶ the site gradient must be sufficiently steep to allow good drainage and prevent standing water, whilst at the same time not compromising the safety or ease of erecting structures;
- ▶ the ground should be stable enough to build safe foundations, roads and infrastructure;
- ▶ the type of ground will determine appropriate foundation, drainage and sanitation options; and
- ▶ the topography may increase the effects of strong winds by funnelling them, or can alternatively provide shelter from the prevailing winds.

📖 The Sphere Project, 2011. *The Sphere Handbook*.

## Water resources and sanitation facilities

30. The site should have access to a clean water supply in order to ensure good health, sanitation and cooking needs, in both the short and long term. Trucking should not be assumed as a sustainable solution, unless it was in use previously and the service remains functional. Water, sanitation and hygiene activities are interdependent and should therefore be assessed simultaneously.



4.2 Access to clean water, Pakistan 📷 Asim Hafeez/IOM Pakistan.

## Space for reconstruction

31. The area of land available should be sufficient for transitional shelter, as well as any planned infrastructure and reconstruction which may take place on the same site. Be aware that in the case of non-displaced populations, properties may not be large enough for both a transitional shelter programme and reconstruction activities on the same site. In addition, the population on the site may vary, due to further returnees to the area, or families moving back from the site to their own land.

1

definition of TS  
10 TS principles  
5 characteristics  
when not to use TS  
SWOT

definition

2

decision-making tool

tool

3

coordination  
programme plan  
assessment  
beneficiaries  
labour  
materials  
procurement  
support  
quality assurance

programme

4

community  
site selection  
site planning  
land tenure  
handover

site

5

socio-cultural  
minimise risk  
climatic design  
materials  
construction

design

resources



### Tip: Non-displaced population

If safe and possible, non-displaced beneficiaries of transitional shelter programmes should stay on the site where reconstruction/major repairs are taking place or as close as possible to their original plot of land.

## 4.2.2 SITE SAFETY

**Limited access** 32. Safety and security issues can place lives, health and early recovery at risk, as well as potentially limiting access to beneficiaries and construction sites.

**Risk assessment** 33. The objective of assessing security and hazards is to determine whether a site is safe or whether its vulnerability to hazards can be reduced through mitigation measures. A careful risk assessment of the site should be undertaken to determine the risks associated with hazards such as:

- ▶ natural and man-made hazards (earthquakes, flooding, volcanic activity, high winds) and their secondary effects (fires, tsunamis, epidemics, landslides);
- ▶ environmental and health issues (industrial pollution, water contamination, vectors and diseases);
- ▶ extreme climatic conditions;
- ▶ proximity to potentially sensitive areas such as current or former conflict areas, international borders and military camps; and
- ▶ the existence of an evacuation route, in case of emergency.

34. Once a site is selected, an assessment can be used to inform hazard mitigation and security measures required to protect the affected population, for example increasing surface water drainage.

### Natural hazards

**Flood-prone areas** 35. Unsafe flood-prone areas are often selected by affected populations because they are the only available sites where land owners do not object to transitional shelters being sited. Alternative sites must be found or engineering works undertaken to mitigate the hazard. The risk of flooding should be identified during sited selection, as well as surface water drainage capacity and the likelihood of ponding, which leads to hygiene problems and the spread of vectors. River banks should be avoided as building sites. The choice of sites with appropriate ground conditions and gradients reduces the risk of exposure to flooding and landslides. The ground type should be suitable to support digging for light foundations and drainage systems, as well as for water infiltration.  The Sphere Project, 2011. *The Sphere Handbook*.



**Flood-prone areas key considerations**

36. Key points to consider in flood-prone areas include:
- ▶ fine clay soils should be avoided as they do not allow water infiltration and can become waterlogged;
  - ▶ sandy soils are good for infiltration but may become unstable; and
  - ▶ site gradient should not be less than 1 per cent as this increases the risk of flash flooding and may require extensive drainage of storm waters.

**Landslide-prone areas**

37. Key indicators can determine whether a site is prone to landslides. These include local knowledge, slip patterns in soil or bands of young vegetation. Vegetation-free areas on slopes, fallen rocks and debris may also be regarded as signs of previous landslides.

**Landslide-prone areas key considerations**

38. Key points for consideration in landslide-prone sites include:
- ▶ at any site gradient, sufficient surface water drainage and erosion measures should be taken;
  - ▶ slopes with little vegetation or a high degree of deforestation should be avoided as vegetation stabilises the soil and reduces the risk of mud slides; and
  - ▶ areas recently affected by wildfire are particularly prone to landslides.

39. Diagram 4.1 shows key considerations for landslide-prone sites.

**Diagram 4.1  
Landslide-prone areas site considerations**

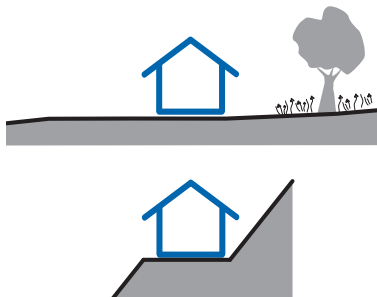

- Appropriate site gradient
- Ground stabilised by vegetation
- Appropriate soil type
- Steep sloping site
- High level of deforestation resulting in little vegetation

**Earthquake-prone areas**

40. Earthquakes pose a severe risk to shelters. Generally earthquake zones are well mapped but the position of actual fault lines may be unknown locally.

**Earthquake-prone areas key considerations**

41. Key guidelines to follow when designing in earthquake-prone sites include:
- ▶ building shelters more than 10m away from steep slopes to reduce danger during rock falls;
  - ▶ observing a minimum safety distance from rock faces and/or retaining walls as rocks may break off during an earthquake;

1

definition of TS  
10 TS principles  
5 characteristics  
when not to use TS  
SWOT

definition

2

decision-making tool

tool

3

coordination  
programme plan  
assessment  
beneficiaries  
labour  
materials  
procurement  
support  
quality assurance

programme

4

community  
site selection  
site planning  
land tenure  
handover

site

5

socio-cultural  
minimise risk  
climatic design  
materials  
construction

design

resources

- ▶ constructing buildings next to visible fault lines, or areas damaged by previous earthquakes, should be avoided;
- ▶ constructing buildings with adequate spacing between them to avoid danger from other collapsing buildings; and
- ▶ avoiding construction on alluvial plains, unstable slopes, unstable soils or reclaimed areas where the ground has not been properly engineered.

42. Diagram 4.2 shows key considerations for earthquake-prone sites.

**Diagram 4.2**  
Earthquake-prone areas site considerations

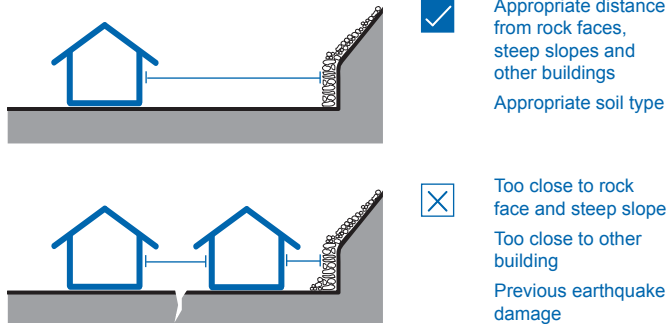

**Hurricane/ cyclone-prone areas**

43. The impact of wind on settlements significantly correlates with their orientation, sitting and layout. When choosing a site, local topography has to be considered in order to prevent settlements from being damaged by storms or heavy winds, and possible floods resulting from these events.

**Hurricane/ cyclone-prone areas key considerations**

44. Key points for consideration in storm-prone sites include:
- ▶ the complexity of wind patterns correlate with the complexity of the topography;
  - ▶ gaps in mountain ranges and valleys can funnel wind;
  - ▶ mountain peaks may be areas of high rainfall;
  - ▶ surrounding vegetation can provide a natural wind barrier;
  - ▶ a minimum distance should be considered from trees or vegetation with thick branches or trunks to prevent damage from falling trees or branches during windy periods; and
  - ▶ considering the direction of prevailing winds in hilly sites and locating buildings either on the far side of the hill or below the peak.

45. Diagram 4.3 shows key considerations for hurricane/ cyclone-prone sites.

**Diagram 4.3**  
Hurricane/  
cyclone-prone  
areas site  
considerations

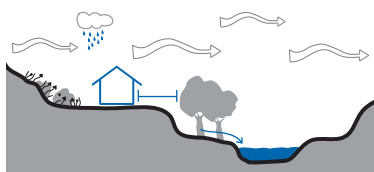

✓ Vegetation used as natural barrier whilst maintaining an appropriate distance  
Prevailing wind direction considered and topography benefits utilised

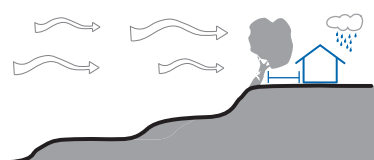

✗ High rainfall on mountain peak  
Too close to vegetation  
Exposed to prevailing wind

**Tsunami-prone areas**

46. If there is a risk of tsunami, a danger zone, exclusion zone, or setback should be determined by specialists, in order to set a minimum distance from the shore when implementing a transitional shelter programme. The establishment and implementation of the danger zone has to be addressed by the national authorities. The enforcement of this zone without an accompanying building policy may lead to livelihood disruptions.

47. Early warning mechanisms may be set in place, as alternative methods to the danger zone, allowing people to build closer to the shore and helping to secure livelihoods. Early warning is only valuable if the population can receive and understand the warning, there are adequate routes available for evacuation and provision is made for vulnerable persons and institutions such as hospitals and schools.

**Volcano-prone areas**

48. In volcano-prone areas, a danger zone has to be determined by specialists in order to set a minimum distance from the danger. This zone has to be agreed in collaboration with national authorities and the communities involved. If construction within this risk area cannot be avoided, continuous monitoring and evaluation of the volcanic activity should be implemented in order to predict possible dangerous levels of activity. Along with this, a volcano emergency plan has to be set up, establishing the identification of major hazard areas, clear identification of population, refuge zones, evacuation routes and public warning procedures.

### Environmental and health issues

**Vector control**

49. Site selection plays a fundamental role in reducing or increasing the impact of vector-borne diseases on a population. Whenever possible, transitional shelters shouldn't be located close to stagnant water, as this is a prime breeding location for mosquitoes and other insects that spread diseases such as

1

definition

definition of TS  
10 TS principles  
5 characteristics  
when not to use TS  
SWOT

2

tool

decision-making tool

3

programme

coordination  
programme plan  
assessment  
beneficiaries  
labour  
materials  
procurement  
support  
quality assurance

4

site

community  
site selection  
site planning  
land tenure  
handover

5

design

socio-cultural  
minimise risk  
climatic design  
materials  
construction

resources

malaria, dengue fever, yellow fever and encephalitis. Consider whether there may be seasonal sources of stagnant water, for example wadis and whether engineering works can achieve drainage or diversions.



4.3 Site prone to vector-borne diseases, Pakistan  IOM Pakistan.

#### Toxic threats

50. Local knowledge is critical for understanding toxic threats and sources of dangerous pollution. Toxic threats may represent sources of illness for beneficiaries and livestock. Surface or groundwater contamination may include saltwater, debris left by floods, sewage, fertilisers and pesticides. Specialist input is required in considering industrial air pollution. Abandoned toxic waste is also a source of toxic contamination, including radioactivity from events involving nuclear power plants.



#### Case study: Groundwater contamination, Bangladesh

“Bangladesh is grappling with the largest mass poisoning of a population in history because groundwater used for drinking has been contaminated with naturally occurring arsenic. It is estimated that 35 to 77 million inhabitants are at risk of drinking contaminated water.”  Smith, A.H et al., 2000. *Contamination of Drinking-Water by Arsenic in Bangladesh*, p.1093.

#### Disease and illness

51. Endemic diseases, pests and risk of disease require special attention when selecting and planning a site. To decide whether measures to prevent and control communicable diseases have to be implemented, assessments of such threats must be conducted. Special care should be given to the evaluation of water resources to ensure that provision of water and sanitation is sufficient to sustain good health. Reliance on a single water source should be avoided and water collecting areas should be located upstream of the camp and fenced.

**Conflict affected areas**

**Sensitive areas**

52. Conflict affected areas may present direct threats from armed incursion, or from targeted or stray impacts from weaponry such as small arms. Displacing civilian populations is a routine military tactic in some regions. Information should be gathered about former conflict areas or military camps from locals, government sources, mine clearing organisations and especially the mandated coordinating body. Mines and unexploded ordnance (UXO) can also be present. Sites should be considered in terms of their military value and their use in any recent conflict, for example an artillery position may contain UXO and may be surrounded by a mine field. Abandoned or overgrown areas may be dangerous. Mines may move during heavy rain or landslides.

**Social and ethnic factors**

53. When selecting a site, social and ethnic factors should be considered. The following indicators should be assessed:

- ▶ proximity to border and/or conflict zone;
- ▶ demographic compatibility, as cultural and ethnic differences can lead to conflict between displaced and host populations;
- ▶ the demographic composition of the beneficiary group, as the beneficiary population may be composed of sub-groups with different religious or ethnic backgrounds;
- ▶ the availability of social networks, as host populations can offer help to aid organisations and beneficiaries through established networks; and
- ▶ whether the beneficiary population is urban or rural, as urban populations displaced to rural locations may encounter unfamiliar challenges, and vice versa.



4.4 Sensitive site, Pakistan  Usman Ghani/IOM Pakistan.

1

definition of TS  
10 TS principles  
5 characteristics  
when not to use TS  
SWOT

definition

2

decision-making tool

tool

3

coordination  
programme plan  
assessment  
beneficiaries  
labour  
materials  
procurement  
support  
quality assurance

programme

4

community  
site selection  
site planning  
land tenure  
handover

site

5

socio-cultural  
minimise risk  
climatic design  
materials  
construction

design

resources

## 4.3

# SITE PLANNING AND COMMUNAL INFRASTRUCTURE

### Physical organisation of a settlement

54. The physical organisation of a settlement will significantly affect the protection, health and well-being of a community, as well as their livelihoods and early recovery. Good site planning will facilitate access to the site, as well as an equitable and efficient provision of communal services, such as a water supply, schools and clinics.

### 4.3.1

## COMMUNITY INVOLVEMENT IN PLANNING SITES AND INFRASTRUCTURE

### Importance of community participation in site planning

55. The affected community and any host population must participate fully in the planning of sites and infrastructure to avoid undermining community efforts, which inevitably are greater than any external support. Community planning may involve workshops »4.1, but should be a continual process, led by a representative committee or directly by the community leaders.

### Influence of hazards on site planning

56. Planning should begin with an understanding of any hazards present and continue to consider topography, access and the location of key communal services and infrastructure. The location of individual transitional shelters therefore becomes the final planning consideration, however, it may then prompt the review of earlier considerations.

### 4.3.2

## SITE MULTI-HAZARD RISK MAPPING AND MITIGATION

### Importance of risk mapping and mitigation

57. During the process of selecting a site, an understanding of potential hazards should be formed »4.2. The site should only be selected if these hazards can be mitigated to ensure safety. However, this may involve engineering works, such as development of surface water drainage, as well as planning to avoid certain areas of the site. These may include areas prone to landslip, erosion, flash flooding, high winds and the potential collapse of damaged buildings.

58. Multi-hazard risk mapping should be undertaken over the whole site, with the affected community, in order to identify existing and potential, natural and man-made hazards that may increase vulnerability and impact safety and livelihoods. For more guidance, consult  University of Cambridge, 2005. *TSDP*, p.205.

**Information for a mitigation plan**

59. Localised hazard mapping for the site may be used to inform the mitigation plan by identifying:

- ▶ areas of the site at risk from hazards;
- ▶ the effect a hazard may have on the lives and livelihoods of the population, for example restrictions on access to services and land use due to temporary flooding;
- ▶ areas with requirements relating to infrastructure and shelter, for example the requirement for additional reinforcement in shelters to protect them from large wind loads; and
- ▶ specific responses, such as restrictions on the use of timber in areas at risk of landslides.

**Relevant information on hazards**

60. A hazard mapping should include information on:

- ▶ the types of hazards;
- ▶ the specific locations of the hazards;
- ▶ the severity of the hazards;
- ▶ when the hazard is likely to occur; and
- ▶ the likely duration of the hazard.

**Extending the area of hazard mapping**

61. Care should be taken to consider not only the area of the site, but also the area immediately around it, as well as probable local factors such as flood plains and areas prone to seismic activity.



**Tip: Participatory Approach for Safe Shelter Awareness**

Participatory tools and methods of disaster risk reduction can be used to raise awareness among the affected population, develop local capacity and appropriate skills in order to reduce shelter related risk.

A key example is PASSA, facilitated by IFRC. This tool is a variation of Participatory Hygiene and Sanitation Transformation (PHAST). It uses eight activities which enable participants to analyse, plan and monitor the shelter approach whilst engaging in the decision-making process at community level.  IFRC, 2011. *PASSA: Participatory Approach for Safe Shelter Awareness*, p.13.

**4.3.3**

**TRANSITIONAL SHELTER SETTLEMENT LAYOUTS AND CONTOUR PLANNING**

**Fitting in to the existing local settlement**

62. The site is unlikely to be isolated, but to be within a broader pre-existing settlement and community. There are likely to be existing zoning and planning codes provided by local authorities. In addition, the site will have routes through it, connections to other routes and a pattern or context for settlement, in terms of density and the type of buildings locally.

1

definition of TS  
10 TS principles  
5 characteristics  
when not to use TS  
SWOT

definition

2

decision-making tool

tool

3

coordination  
programme plan  
assessment  
beneficiaries  
labour  
materials  
procurement  
support  
quality assurance

programme

4

community  
site selection  
site planning  
land tenure  
handover

site

5

socio-cultural  
minimise risk  
climatic design  
materials  
construction

design

resources



**Self-settled site upgrading**

63. Humanitarian organizations planning to implement transitional shelter projects often arrive at a site which has already been self-settled with self-built shelters. At a project's starting point, organisations have to consider working with the community, in order to achieve a phased plan for upgrading the site.

**Leaving space for reconstruction**

64. The transitional shelter programme is intended to offer shelter over the period of transitional reconstruction. In doing this, the planning of the final settlement must be assisted and not compromised by the transitional shelter programme. Consideration should be given to the final probable location of communal services and infrastructure, as well as houses and apartments. Space should be left for construction sites and access by vehicles and plant, including storage for materials, concrete mixers, trucks and cranes.

**Understanding topography and settlement layouts**

65. Topography is often the key factor in the physical layout of a site. Local traditional settlement layouts should be studied to understand why they have evolved in that manner. Further consultation, workshops may be used to identify reasons relating to culture, livelihoods and climate, which should all be reflected as much as possible in the community planning process.

**Contour planning and surface water drainage**

66. In most cultures, shelters are traditionally orientated along the slope, following the contour of the land. This is so that there is minimal drop across each site, and so that roads and paths do not run directly down a slope, to reduce the velocity of surface water in drainage. This contour planning approach should be noted as a method of considering the planning of the overall site, as well as the infrastructure, services and sections for transitional shelter within it.

---

## **4.3.4 SITE ACCESS**

**Opening and maintaining access roads**

67. It is likely that access routes to resources, nearby towns, villages and land on which livelihoods are supported will already have been established. Upgrading and relocating these access routes may be required to:

- ▶ minimise erosion and environmental degradation;
- ▶ respond to land ownership and use;
- ▶ control access to the site;
- ▶ control access to protected natural resources and areas of high risk; and
- ▶ allow access of both the emergency services and large vehicles for distributions.

**Priorities for upgrading and relocating access roads**

68. When upgrading and relocating access roads, the following should be addressed:

- ▶ identify areas regularly visited by the affected population;



- ▶ avoid taking main access routes through existing settlements;
- ▶ avoid steep inclines;
- ▶ ensure separate vehicle and pedestrian access; and
- ▶ maximise the visibility of vehicles by keeping roadsides clear.

69. Seek specialist advice for the construction and maintenance of roads, particularly if the area is to be used by heavy goods vehicles.

### 4.3.5

## COMMUNAL INFRASTRUCTURE AND SERVICES

#### Re-establishing and developing infrastructure and services

70. Before a conflict or disaster, a community will have had established communal services and infrastructure, such as a water supply, schools, clinics, roads, bridges and market places. Community planning to re-establish these, should consider their previous locations and agree the assistance required for each. A post-disaster environment may offer the opportunity to improve upon previous provisions.

#### Permanent and transitional infrastructure and services

71. The transitional shelter programme may require different communal infrastructure and services than final reconstruction. In addition, the priorities of the community may be to accept different provisions while focusing capacity and resources upon final reconstruction. In undertaking work, priority is often given to repairing or reconstructing existing infrastructure and services, so that they can be used sustainably following final reconstruction. In some circumstances, however, transitional measures may be needed, for example a transitional school or learning space might be constructed so that lessons might continue while the school was being rebuilt.

#### Coordination with WASH

72. It is important to ensure that the site plan supports the activities of WASH. The transitional shelter programme should ensure that WASH priorities are integrated fully into the programme and that WASH specialists participate in community planning activities.

#### Water supply considerations

73. Water supply and sanitation facilities should ensure that:
- ▶ internationally agreed standards are met where appropriate;
  - ▶ maximum sustainable use is being made of local natural resources, water supply and sanitation facilities;
  - ▶ needs are being met in relation to livelihood support and requirements for construction as well as survival needs, including drinking, washing and cooking;
  - ▶ the health of the population is not at risk;

1

definition of TS  
10 TS principles  
5 characteristics  
when not to use TS

definition

SWOT

2

decision-making tool

tool

3

coordination  
programme plan  
assessment  
beneficiaries  
labour  
materials  
procurement  
support  
quality assurance

programme

4

community  
site selection  
site planning  
land tenure  
handover

site

5

socio-cultural  
minimise risk  
climatic design  
materials  
construction

design

resources

- ▶ all members of the affected population, including vulnerable groups, have equitable access to water;
- ▶ security issues are taken into account when planning sanitation facilities; and
- ▶ water supply and sanitation are located appropriately.

**Leaving space for upgrading and extending sanitation facilities**

74. When planning any upgrades or extensions of sanitation facilities and infrastructure it is important to leave space for subsequent upgrading of sanitation. For example, some transitional settlement programmes start with communal defecation fields which are then upgraded to family or communal latrines. Agreement must be reached with the community and the sanitation specialist to identify the end state and transitional stages, and set aside areas of land to accommodate these stages.

75. The following points should be considered:

- ▶ the standard of existing facilities;
- ▶ possible locations of additional latrines;
- ▶ direction of the prevailing wind; and
- ▶ risk of gender-based violence and the need for privacy.

**Upgrading and extending sanitation facilities**

76. When planning the upgrade and extension of water sources and infrastructure, the following points should be considered:

- ▶ the size of the population and the possibility of future population growth and influxes;
- ▶ site topography;
- ▶ the quantity of water required for construction and livelihood support;
- ▶ internationally agreed standards; and
- ▶ the quality of water available locally.

**Supporting education networks**

77. Education is every child's right and has benefits far beyond academic achievement. It is life sustaining and life saving through its effect on physical, psychosocial and cognitive welfare. Education can build and strengthen social cohesion within a community that has experienced upheaval or shock from conflict or disaster. Infrastructure support must be made with the full participation of the relevant ministry of education, sector specialists and all stakeholders, based on an understanding of the educational systems and traditions of the affected population. If active in the affected region, the IASC Education Cluster should be consulted as a source of support and advice. Such support mechanisms should be implemented taking into account existing capacities. The use of existing school infrastructure may be possible, in which case support should be provided to local schools through the supply of staff and teaching materials, such as desks, chairs and blackboards.

**Key considerations for school buildings**

If constructing a school building, choose a structure that could be used for a variety of purposes, and collaborate with the local authorities to make it possible to convert it to a different use when the camp closes.

78. Specific considerations when planning school buildings include the following:

- ▶ community members, including young people, participate in the construction and maintenance of the learning environment;
- ▶ make sure the space is sufficiently ventilated and heated in cold climates;
- ▶ provide safe water and appropriate sanitation facilities;
- ▶ safety and accessibility of learning structures, incorporating disaster-resilient design and construction;
- ▶ access and facilities for all users, including those with disabilities; and
- ▶ adequate space and seating to allow for participatory teaching methodologies.

Adapted from  INEE, 2010. Minimum Standards for Education; Preparedness, Response, Recovery, p.68.

**Supporting health networks or structures**

79. Health services will be required in order to support the affected population. These also should be set in place whilst considering previous assessment of the existing facilities. Health infrastructures should be planned in order to respond to:

- ▶ survival needs;
- ▶ long-term health needs; and
- ▶ risk of disease.

**Supporting existing local facilities**

80. When local facilities are available, the local authorities may allow the displaced population to use them. If the infrastructure is inadequate, support should be provided, in the form of medical staff, clinical materials and pharmaceuticals.

**Requirements for a transitional shelter programme**

81. If there are suitable hospitals within easy reach, only minor infrastructure will be required as part of the transitional shelter programme, such as:

- ▶ screening facilities within reception centres;
- ▶ outreach clinics within blocks or sectors of the camp, with or without small surgery facilities; and
- ▶ dispensaries.

Adapted from  University of Cambridge, 2010. *TSDP*, p.395.

82. The following section discusses land tenure, which is a major issue regarding site planning and communal support.

1

definition of TS  
10 TS principles  
5 characteristics  
when not to use TS  
SWOT

definition

2

decision-making tool

tool

3

coordination  
programme plan  
assessment  
beneficiaries  
labour  
materials  
procurement  
support  
quality assurance

programme

4

community  
site selection  
site planning  
land tenure  
handover

site

5

socio-cultural  
minimise risk  
climatic design  
materials  
construction

design

resources



## 4.4 LAND TENURE

83. This section introduces key concepts in regard to land issues in a humanitarian context and the benefits and limits of a transitional shelter approach. It then addresses legal frameworks and incremental approaches to increasing tenure security, before presenting methods of land identification, key stakeholders and key considerations in forming multi-party contracts.

### 4.4.1 THE IMPORTANCE OF LAND AND LAND TENURE

**What is land tenure?**

84. Land tenure refers to the set of rules or the relationship between people as regards ownership and access to land. Rules of tenure define how rights to land are allocated, i.e. how access is granted, to which land, for how long, for what purposes and under what conditions.

**The dynamic nature of land tenure**

85. Land tenure systems are dynamic and vary from place to place, both between and within countries, according to the socio-economic, political, cultural and institutional context. Tenure systems can be well-defined and enforced, whether formal (recognised in law) or informal, or full of ambiguities and open to exploitation.

**The vital role of land access**

86. Issues of access to land are recognised as a central concern in post-disaster response. Access to land is necessary to provide a basis for shelter and is often the primary means for restoring social and economic activities.

**Impacts of tenure type**

87. Tenure type can directly affect the likelihood of displacement after a disaster and the chances of a rapid return. Security of tenure is vital to facilitate shelter reconstruction, social and economic recovery and restoration of livelihoods, particularly home-based enterprises.

### 4.4.2 TENURE SECURITY

**The importance of tenure security**

88. Security of tenure refers to the certainty a person has that their rights to land will be recognised by others and protected in the case of a specific challenge. Tenure security is not simply about legality, but also about rights and perceptions. Without tenure security, households are hindered from starting to rebuild their lives.

**Formal and informal tenure**

89. Security of tenure does not mean having formally registered, legally recognised ownership. Many informal

systems are well accepted and understood, and short- and medium-term ways of securing tenure can provide protection from eviction and a basis for rebuilding livelihoods.

### 4.4.3 THE IMPACT OF A DISASTER ON LAND

#### Impact of a disaster

90. Land tenure issues that are apparent after a disaster are often not new, but the disaster may have exacerbated weaknesses in land tenure systems. Disaster can increase land related insecurity and conflicts due to the breakdown of traditional tenure arrangements and the social relations on which society is based.

#### Land issues affect the response

91. Land tenure arrangements will affect the possibility of being displaced, the likelihood of a rapid return, the chance of accessing and installing a transitional shelter kit, and the possibility of reconstruction. Often efforts to provide shelter assistance or basic services are hindered by insecure tenure, disputes over land or lack of ability to identify land on which to accommodate the displaced.

#### Land assessments

92. Early identification of land issues and tenure systems can provide the key to early and sustainable recovery, facilitate post-disaster reconstruction and reduce unanticipated consequences. A land assessment can provide vital information on tenure regimes and institutional arrangements to determine or enforce rights. A comprehensive land assessment should be carried out as soon as possible by a team of specialists. Information should be shared and responses coordinated with other agencies. For more information on land assessments see  UN-HABITAT, 2010. *Land and Natural Disasters*, Chapter 3.

### 4.4.4 LAND AND THE TRANSITIONAL SHELTER APPROACH

#### The role of transitional shelter

93. Transitional shelter as an approach includes an inherent flexibility that can overcome some of the common problems associated with the provision of shelter after a disaster. The possibility to relocate, recycle, reuse, resell or upgrade the transitional shelter provides households with dignity and improved security across a range of tenure situations.

#### Common problems

94. The disaster may result in:
- ▶ land being irretrievably lost to landslides or flooding;
  - ▶ boundaries which are no longer identifiable;
  - ▶ lost or destroyed title documents;
  - ▶ termination of the conditions under which the tenure existed;
  - ▶ ownership of the land being difficult to prove if it was inherited or no documents existed; and

1

definition of TS  
10 TS principles  
5 characteristics  
when not to use TS  
SWOT

definition

2

decision-making tool

tool

3

coordination  
programme plan  
assessment  
beneficiaries  
labour  
materials  
procurement  
support  
quality assurance

programme

4

community  
site selection  
site planning  
land tenure  
handover

site

5

socio-cultural  
minimise risk  
climatic design  
materials  
construction

design

resources

- ▶ tenants being unable to return to their original plot of land or engage in reconstruction.

**Flexibility over time** 95. Land conflicts often take a considerable amount of time to be resolved. Transitional shelter allows a household facing such problems to be accommodated before issues of land reach a legal resolution.

**Flexibility in relocation** 96. Where tenure is insecure or can only be established for a limited period of time, the transitional shelter approach allows the household to relocate the shelter when necessary. Where it has been ascertained, the shelter can be upgraded or recycled.



**Attention: Real estate speculation**

Real estate speculation might happen after a disaster, putting pressure on the relocation characteristic of a transitional shelter approach. Humanitarian organisations need to make sure that they are not complicit with such events.

## 4.4.5 LIMITS OF TRANSITIONAL SHELTER

**What transitional shelter cannot do** 97. Shelter as an approach will never be able to solve land tenure issues itself, as these are rooted in legal and social relations. It also cannot address inherent inequality in tenure systems, such as gender bias, although measures should be taken within the programme to address these issues. 📖 FAO, 2002. *Gender and Access to Land*.

**Risk of unresolved land issues** 98. Short-term solutions can become long-term settlement if displaced persons face barriers to return or relocation. Particular measures must be taken to ensure that sites which are regarded as temporary do not become long term.

**Risk of government complacency** 99. As many land issues arise because of weaknesses in the pre-disaster system, there must be recognition that certain issues will require long-term reform to resolve. There is a danger that governments use the provision of transitional shelter as a justification for a lack of action in the long term.

**Risk of land-owner bias** 100. As households require access to land in order to construct a transitional shelter, there is a tendency to favour owners over tenants and squatters. Steps must be taken to ensure that the most vulnerable, such as the landless, tenants or female-headed households, are supported. This additional support may require alternative assistance methods such as cash to rent land or legal advice.

## 4.4.6

# LEGAL FRAMEWORKS AND INFORMAL PROCESSES

### Legal frameworks

101. Transitional shelter programmes must always take place in recognition and respect of the laws, land use plans and building codes governing the country of operation. Responsibility for land tends to be fragmented between various ministries, agencies and authorities at different levels of government. This can result in weak land administration and high levels of informality.

1  
definition of TS  
10 TS principles  
5 characteristics  
when not to use TS  
SWOT

### Need for specialist teams

102. Specialist teams should be employed to analyse policy, institutional frameworks, overlaps and gaps, and provide recommendations for response 📖 The World Bank, 2010. *Safer Homes, Stronger Communities*, Chapter 7, Annex 2. Specialists will be able to advise on where international human rights laws or humanitarian principles fit if national laws are insufficient. 📖 COHRE, 2005. *The Pinheiro Principles*.

2  
decision-making tool

### Situations with high levels of informality

103. In situations where there is a high level of informality, widely acknowledged extra-legal systems (e.g. those neither, explicitly in or against the law) may provide adequate tenure security. Shelter interventions should aim to understand and build on the tenure system that was in place prior to the disaster. Addressing the complex issue of tenure informality and incremental tenure security will enable quicker recovery. 📖 Crawford, K. et al., 2010. *Coordination and the Tenure Puzzle In Haiti*.

3  
coordination  
programme plan  
assessment  
beneficiaries  
labour  
materials  
procurement  
support  
quality assurance

## 4.4.7

# USING AN INCREMENTAL APPROACH TO INCREASE SECURITY

### Using a flexible tenure approach to obtain security

104. Promoting a range of tenure options, such as short-term use rights or statements of permission can reduce the risk of eviction and promote recovery 📖 Payne, G., 1997. *Urban Land Tenure and Property Rights in Developing Countries*. Flexible hierarchies of evidence and state-issued permits (i.e. certificates of use, written authorisation to occupy, sworn statements, community verification) can ensure that people without legal documentation can participate in shelter programmes.

4  
community  
site selection  
site planning  
land tenure  
handover

### Establishing transitional shelter as the property of the beneficiary

105. Informal mechanisms can never fully eliminate the risk of eviction. Whatever the tenure situation, in all cases, the shelter should remain the property of the beneficiary. This may not be consistent with local practices (e.g. where buildings on leased land revert to the owner of the land) and special reference should be made in agreements so that households retain physical possession if relocated.

5  
socio-cultural  
minimise risk  
climatic design  
materials  
construction

definition

tool

programme

site

design

resources

#### 4.4.8

## LAND OWNERSHIP IDENTIFICATION METHODS

### Issues in land identification

106. Identifying land ownership can often be a difficult task. In many countries significant amounts of land are not covered by official records. Information may be contradictory or scattered across departments, while databases may be incomplete or out of date. A disaster often results in added confusion through the loss of both records and key personnel. There is a need to be wary of parties that may seek personal gain in the resultant chaos and uncertainty.

### Formal methods of land identification

107. Formal means of identifying land are based on searching official land registers. Where these are incomplete it may be possible to use tax records to trace ownership, or utility bills to confirm occupancy. Notaries or surveyors may also be able to provide insight on land boundaries and ownership.

### Informal methods of land identification

108. Where such formal methods are unattainable, a community or locality may hold the greatest knowledge of land use and ownership. Compile information from local leaders, individual households and the public to generate community maps. Consultation with local community members and officials can also provide important information on land which appears vacant. This may for example be used seasonally or be under dispute.

### Urban areas and enumeration

109. In urban areas, due to increased complexity of tenure arrangements, community mapping or enumeration procedures combined with action planning can be employed to identify and negotiate access to land for shelter and priorities for reconstruction. 📖 UN-HABITAT, 2010. *Count Me In*.

### Important stakeholders

110. Key stakeholders as regards transitional shelter programmes include:

- ▶ national government;
- ▶ local municipality;
- ▶ affected household;
- ▶ local community;
- ▶ private landowners; and
- ▶ implementing agencies.

111. For a more detailed list of other potential stakeholders see 📖 UN-HABITAT, 2010. *Land and Natural Disasters*, p.11.

#### 4.4.9

## MULTI-PARTY AGREEMENTS

### Tripartite contracts

112. Contracts between the affected household, local government and implementing agency can be used to obtain permission and establish tenure security for transitional shelter.



**Quadripartite contracts**

Contracts should define the roles and responsibilities of each party and the timeframe of occupation, while longer term rights of access are resolved or upgraded.

113. NGOs may also advocate on the behalf of a community with a private landowner, or with the support of the local municipality to form a quadripartite agreement. Land owners may be more likely to agree to allow the use of their land for a specified time period if such use has political backing from the local government.

**Key considerations**

114. As a summary, all transitional shelter programmes should aim to:

- ▶ recognise and support a range of tenure options;
- ▶ use and build on local knowledge and systems;
- ▶ seek to increase security;
- ▶ advocate long-term recognition of rights;
- ▶ consider budgeting to include legal fees or land costs;
- ▶ promote coordination between agencies; and
- ▶ ascertain steps for transition to long-term security.

**Additional information**

115. This section addresses some key considerations but is by no means an attempt to fully cover the issues raised. Further reading is highly recommended for those engaged in transitional shelter programmes, in particular  UN-HABITAT, 2010. *Land and Natural Disasters*.

1

definition of TS  
10 TS principles  
5 characteristics  
when not to use TS  
SWOT

definition

2

decision-making tool

tool

3

coordination  
programme plan  
assessment  
beneficiaries  
labour  
materials  
procurement  
support  
quality assurance

programme

4

community  
site selection  
site planning  
land tenure  
handover

site

5

socio-cultural  
minimise risk  
climatic design  
materials  
construction

design

resources



## 4.5 HANDOVER

116. A transitional shelter approach is a process, not a product. Many stakeholders and agencies are therefore involved in a transitional programme over a long period of time at different stages of the response. To ensure that support for beneficiaries is continuous, proper handover procedures should be implemented. The following section gives a brief overview of the key considerations with regard to handover.

### 4.5.1 HANDOVER CONSIDERATIONS

#### Handover as a process

117. Handover should be regarded as a process on its own. Communities or individuals within a programme may have their shelters handed over at different times. The same applies for the inter-organisational level. Therefore handover should be regarded as a continuous process throughout the programme.

#### Transition to what?

118. Transitional shelter programmes are often open to the question of “Transition to what?” This question should be responded to within the programme strategy in order to clarify who takes over support for beneficiaries at the point when the implementing organisation ends its contribution.

119. In addition, it is vital to agree who will continue the support of different sector components such as WASH. »3.1.3

#### Continuous responsibilities

120. If the implementing organisation continues to have a presence in the country, but does not continue to have a shelter department, then it may still have some legal responsibility for the state of the shelters, post-occupancy. This question needs to be clarified for each specific situation. If this is the case, a partner organisation should be ensured in order to continue support to the programme beneficiaries.

#### Preparation of handover

121. Handover strategies should ideally be prepared during the first meetings between the communities and local authorities before the implementation of the project in order to manage expectations. Planned handover dates, the residually retained responsibilities of the organisation after the end of the project, and the beneficiary and government expectations regarding the maintenance, upgrading or replacement of the shelters should be agreed on. In addition it has to be clearly stated which components, i.e. tools or machines, will not be handed over.

**Recording of agreements**

122. The above mentioned expectations should be recorded in writing in the initial memorandum of understanding and the tripartite agreement with the community and the local authorities. »4.4.9

**Setting up a certificate of handover**

123. For the actual handover of a single shelter to an individual beneficiary household, it is recommended to use prepared certificates of handover. The wording of the certificate should be agreed upon by the “Shelter Cluster”, the government authorities and beneficiary communities. It should clearly state the following points:

- ▶ name of organisation;
- ▶ name of beneficiary;
- ▶ date of handover of the transitional shelter;
- ▶ number of shelters, in case of extended families;
- ▶ that the shelter and its components are property of the beneficiary; and
- ▶ references to any multipartite agreements concerning land rights. »4.4.9

**Handing over the certificate**

124. Where possible, the certificate should be handed over and signed by all parties by a representative of the humanitarian organisation, in public at the location of the shelter itself.

125. Through this chapter shelter practitioners should have been enabled to support beneficiaries with site selection and planning as well as communal infrastructures. In addition an understanding has been established of how to deal with land tenure issues and handover procedures in the course of a transitional shelter programme. In the following chapter further information will be given on how to design the actual shelters bearing the main socio-cultural considerations in mind. Elaborations on climatic and risk minimising design as well as materials and construction principles will be presented.

1

definition of TS  
10 TS principles  
5 characteristics  
when not to use TS  
SWOT

definition

2

decision-making tool

tool

3

coordination  
programme plan  
assessment  
beneficiaries  
labour  
materials  
procurement  
support  
quality assurance

programme

4

community  
site selection  
site planning  
land tenure  
handover

site

5

socio-cultural  
minimise risk  
climatic design  
materials  
construction

design

resources



# 5 COMMUNITY SHELTER DESIGN

## Chapter contents

---

<b>5.1</b>	<b>DESIGNING WITH THE COMMUNITY</b>	
5.1.1	Designing for daily life	138
5.1.2	Accessibility	145
<b>5.2</b>	<b>DESIGNING TO MINIMISE RISK</b>	
5.2.1	Natural hazards	147
5.2.2	Health considerations	155
5.2.3	Fire prevention	157
5.2.4	Security	158
<b>5.3</b>	<b>CLIMATIC DESIGN</b>	
5.3.1	Internal conditions	159
5.3.2	Design considerations for warm-humid climates	161
5.3.3	Design considerations for hot-dry climates	164
5.3.4	Design considerations for cold climates	166
<b>5.4</b>	<b>BUILDING MATERIALS</b>	
5.4.1	Local construction techniques and materials	169
5.4.2	Common construction materials	170
<b>5.5</b>	<b>CONSTRUCTION PRINCIPLES</b>	
5.5.1	Foundations	181
5.5.2	Floors	186
5.5.3	Walls	188
5.5.4	Roofs	191
5.5.5	Maintenance	193



# 5.1

# DESIGNING WITH THE COMMUNITY

## Introduction

1. Designing a transitional shelter requires many culturally-specific considerations to be identified and reflected, so that the shelter can support daily activities such as religious observances, sleeping, cooking and eating, washing and cleaning, child care, and home based enterprises linked to livelihoods. Appropriate design for these activities is possible only with the full participation of the affected community. Additional and specific support must be given to vulnerable people within the community, such as the aged, as well as those with special needs, such as the disabled.

## 5.1.1

## DESIGNING FOR DAILY LIFE

### Customs and traditions

## Customs and traditions

2. Customs and traditions, cultural habits and other activities of daily life should be reflected when designing a transitional shelter and also inform the design of the entire programme »Chapter 4. Daily life changes with seasons and so does the role of shelter, for example for use for storing crops after a harvest or for performing craft-based activities during a long monsoon or winter. Daily life is also dependent on the composition of the household such as the presence of the elderly or young children. Appropriate shelter design should take this, and the fact that there may be changes over the period of use, into account.

3. The community itself may not have considered how these customs and activities impact upon the design of their transitional shelter. Committees, meetings and workshops can all be used to reflect customs and activities in the design, contributing also national legal requirements such as building codes and humanitarian standards agreed for the response.

# 1

definition of TS  
10 TS principles  
5 characteristics  
when not to use TS

definition

# 2

SWOT

tool

# 3

decision-making tool  
coordination  
programme plan  
assessment  
beneficiaries  
labour  
materials  
procurement  
support  
quality assurance

programme

# 4

community  
site selection  
site planning  
land tenure  
handover

site

# 5

socio-cultural  
minimise risk  
climatic design  
materials  
construction

design

resources



#### 5.1 Community meeting, Pakistan 📷 IOM Pakistan.

### Important questions

4. Consultations with the community over customs and activities may include the following questions:

- ▶ What role does religion play within the community and daily life?
- ▶ What property rights and/or land tenure issues were in place prior to the disaster?
- ▶ What is the nature of internal spaces within traditional dwelling types, such as divisions between activities, ambience, lighting, ventilation, heating and cooling?
- ▶ What are the everyday household activities, such as sleeping, washing, cooking and cleaning, even economic activities, and where in their previous homes were they undertaken?

5. Together with physical safety from hazards, the protection of family members must be central to the humanitarian contribution of transitional shelter. With careful consideration of cultural norms and the involvement of protection specialists where appropriate, both direct and indirect consultation methods may be used to form an understanding of:

- ▶ the typical division of labour in household and community activities;
- ▶ any discriminatory practices existing within the community that may impact men, women or children; and
- ▶ actions to be undertaken to prevent exploitation.

Questions adapted from 📖 IASC, 2006. *Women, Girls, Boys and Men*, p.99–100.

### Status

### Status

6. Cultural status and the different livelihoods of community members, including different levels of financial income, must be considered when designing and implementing a transitional

shelter programme. In many societies, different cultural groups coexist. Contention over politics, economic power and inequality within the community may already be present  CRISE, 2007. *Cultural Status Inequalities*, p.2. The cultural status of any group present must not be undermined. Care must be taken when planning a site, designing a shelter, choosing materials and allocating resources to support the livelihood activities of each group equitably.

7. Status differences will exist within a specific group or household. Therefore, engaging the participation of representatives within the affected population of different ages, ethnicities, religions and languages is necessary for successful transitional shelter design.

8. With careful consideration of cultural norms and involving protection specialists where appropriate, questions regarding the cultural status within the community may focus on:

- ▶ if the affected population includes groups with differing religions or ethnicities and if this might contribute to conflict;
- ▶ outlining the specific roles and influences of men, women and children with regard to decision making and construction; and
- ▶ establishing who typically works in the home and who works outside the home.

Questions adapted from  IASC, 2006. *Women, Girls, Boys and Men*, p.99–100.



### **Field experience: The importance of understanding social structure**

“Many in Sri Lanka perceive ideas about participation to be counter-cultural. Relations between people in different social groups and categories tend to be both prescriptive and hierarchical. Very few civilians are accustomed to exercising choice, or to being involved in decision making. Even the notion of consultation is foreign.

The situation is very different in Eastern DRC, where civil society is extremely active, as evidenced by the strong network of local NGOs that play a key role in humanitarian and development initiatives. International organisations, however, often fail to recognise the value of local NGOs and appear to work directly with civil society, which is a source of frustration for local NGOs”.  ODI, 2003. *Participation by Crisis—Affected Populations in Humanitarian Action*, p.50.

**Questions concerning status**

1

definition

definition of TS  
10 TS principles  
5 characteristics  
when not to use TS  
SWOT

2

tool

decision-making tool

3

programme

coordination  
programme plan  
assessment  
beneficiaries  
labour  
materials  
procurement  
support  
quality assurance

4

site

community  
site selection  
site planning  
land tenure  
handover

5

design

socio-cultural  
minimise risk  
climatic design  
materials  
construction

resources

## Family composition

### Family composition

9. An understanding of family compositions within a community is integral to achieving a successful transitional shelter programme. The shelter response should not only aim to preserve family structure but identify families, children or unaccompanied women with non-typical family structures.

10. Analysis should be undertaken with regard to how the community currently offers support to such vulnerable groups, in order to inform the transitional shelter design strategy accordingly.

### Questions concerning family structure

11. Questions regarding typical family structures within the community may include:

- ▶ what are the total number of households and average number of family members categorised by age and gender? and
- ▶ is it a patriarchal or matriarchal social system?

Questions adapted from  IASC, 2006. *Women, Girls, Boys and Men*, p.99–100.

## Gender issues

### Gender issues

12. Gender issues are important to consider throughout a transitional shelter approach. These do not only include the specific needs of women, their roles within the community and identified vulnerabilities, but also those of men. It should not be assumed that women and children are at greatest risk. Men and women have different capacities and coping strategies and therefore should be assessed with equal importance.

13. Traditional gender roles are important not only in the daily life of a transitional shelter, but also in its incremental construction. In most cultures women and men undertake different activities, which need to be reflected in the transitional shelter process.

14. The transitional shelters and programmes should be designed not to pose any additional risks to individuals or groups within the affected population. Successful gender analysis can ensure no further marginalisation occurs and may also highlight the potential for positive change in gender relations.  Institute of Development Studies, 1995. *Gender, Emergencies and Humanitarian Assistance*, p.i.

### Questions concerning gender

15. Questions regarding gender issues within the community may include:

- ▶ what vulnerabilities can be identified, that are associated specifically with men or women?
- ▶ how can women meaningfully participate in the decision-making process?



- ▶ what actions will be undertaken to prevent exploitation of women? and
- ▶ is it culturally acceptable to accommodate single women in separate shelters or should they be accompanied by a male relative?

Questions adapted from IASC 2006. *Women, Girls, Boys and Men* p.99–100.



5.2 Participation of women in the decision-making process, Pakistan IOM Pakistan.



### Field experience: El Salvador earthquake, 2001—Gender related issues

In early 2001, El Salvador experienced two earthquakes resulting in 1,260 people killed and extensive damage to buildings, including 113 healthcare facilities. In terms of the emergency shelter response, single women within the community insisted that the sheeting provided for temporary shelters be strong and opaque. Previous translucent materials made it easy to identify isolated women and could be cut, resulting in possible abuse. The World Bank, *El Salvador* [online], ODI, 2003. *Participation by Crisis—Affected Populations in Humanitarian Action*, p.299.

### Privacy and security

16. Privacy and security within a home and throughout a community vary from place to place and from culture to culture. An analysis of traditional measures in place will provide an insight and possible solutions to the specific nature of each response.

17. Privacy is particularly challenging in communal shelter programmes. The risk of abuse to individuals and vulnerable groups due to lack of privacy and security is typically higher at night. IASC, 2006. *Women, Girls, Boys and Men*, p.2.

### Privacy and security

1

definition of TS  
10 TS principles  
5 characteristics  
when not to use TS  
SWOT

definition

2

decision-making tool

tool

3

coordination  
programme plan  
assessment  
beneficiaries  
labour  
materials  
procurement  
support  
quality assurance

programme

4

community  
site selection  
site planning  
land tenure  
handover

site

5

socio-cultural  
minimise risk  
climatic design  
materials  
construction

design

resources

**Questions concerning privacy**

18. Questions regarding privacy issues within the community may include:

- ▶ traditionally what privacy and security measures are in place between dwellings?
- ▶ are rooms partitioned to achieve a level of privacy between ages or genders? and
- ▶ are room types such as sleeping facilities secured with locks (doors and windows)?

Questions adapted from  IASC, 2006. *Women, Girls, Boys and Men*, p.99–100.

**Material selection**

**Material selection**

19. Material choice » 5.4 may be related with cultural status within the community. Consideration should be given to possible social impacts such as dissatisfaction, rejection of the support, or even to possible social conflict.  UNEP and SKAT, 2007. *After the Tsunami*, p.3.

20. Culturally appropriate material choice is also likely to reflect local best practice gained over a considerable period of natural resource management. Selecting materials can aid protection of natural resources » 5.4 both in the affected region and further afield as well as reduce energy consumption, pollution and therefore the carbon footprint of the response. Alongside environmental benefits, sustainable construction management can offer financial benefits and may provide a number of safety advantages.

21. Cultural norms will be based upon the maintenance of traditional homes, rather than the immediate sheltering of a considerable proportion of a community within a context where the environment may also have been impacted by the conflict or disaster.

**Questions concerning culture and materials selection**

22. Questions regarding appropriate material choices may include:

- ▶ what types of transitional shelter materials will be appropriate to the specific culture and context?
- ▶ have agreements been made with regard to the use of local materials and the subsequent affect on biodiversity and available natural resources?
- ▶ have sustainability and longevity of materials been considered? and
- ▶ how are the materials to be allocated and how will this affect minority groups and women?

Questions adapted from  IASC, 2006. *Women, Girls, Boys and Men*, p.99–100.



5.3 Culturally appropriate material choice, Pakistan 📷 *Usman Ghani/IOM Pakistan.*



### Case study: Haiti earthquake, 2010—Shelter design with the community

Since the earthquake that struck Haiti in January 2010, Cordaid has been implementing the construction of transitional to permanent shelters in the communes of Grand Goave and Leogane. 151 T-shelters were completed in the first prototype phase, and have since been upgraded to incorporate the material and design changes compliant with vernacular characteristics, as suggested by the local community. Some technical modifications have also proven necessary for the structure to better withstand earthquakes, hurricanes and termite attacks.

The timber-frame prefabricated structure and panel-system, built by a Haitian factory, has a lifespan of approximately 15 years. The construction is carried out by the beneficiaries, with assistance from trainees from local vocational training centres. In order to ensure the shelters' transition to permanent constructions, Cordaid has provided both training and resources to the beneficiaries. As of September 2011, 1610 permanent T-shelters have been completed alongside 4,268 shelter frame kits. 📖 Caritas/Cordaid, 2010. *Shelter design with the community.* 📖 Cordaid Haiti, *Result Update* [online].

1

definition of TS  
10 TS principles  
5 characteristics  
when not to use TS  
SWOT

definition

2

decision-making tool

tool

3

coordination  
programme plan  
assessment  
beneficiaries  
labour  
materials  
procurement  
support  
quality assurance

programme

4

community  
site selection  
site planning  
land tenure  
handover

site

5

socio-cultural  
minimise risk  
climatic design  
materials  
construction

design

resources



5.4 Transitional shelter materials prototype, Haiti 📷 Cordaid Haiti.

## 5.1.2 ACCESSIBILITY

### Accessibility in shelter design

23. Following a disaster it is important to provide additional support to the most vulnerable people including pregnant women, children, the elderly, sick and those with disabilities. Such groups may become increasingly marginalised without adequate assistance. Consideration of accessibility issues in both site and shelter design is key to ensuring basic needs are met and accessibility is achieved for all.

### Questions concerning accessibility

24. Questions regarding accessibility within the community may include:

- ▶ what systems are in place to assist the elderly or those with disabilities?
- ▶ are there any individuals or groups who may need additional shelter support? and
- ▶ how can the specific design of the transitional shelter offer ease of access?

Questions adapted from 📖 IASC, 2006. *Women, Girls, Boys and Men*, p.99–100.



### **Field experience: Haiti earthquake displaced, 2010—Accessibility for all**

Following the earthquake which struck Haiti in January 2010, Handicap International rolled out a humanitarian response, the largest in its history. Among other things the association aims to ensure the most vulnerable people including amputees, quadriplegics and paraplegics are given access to a complete range of services. In terms of transitional shelter support, a database of “particularly vulnerable persons” has been set up in Port-au-Prince in order to meet the specific needs of families with disabled members. By August, in addition to the distribution of tents,

45 temporary shelters featuring ramped access were constructed, each designed to cater for people with reduced mobility.

Handicap International, *Haiti Situation Update*, 2010 [online].



5.5 Transitional shelter with ramped access, Haiti  Sylvia Sommella/Handicap International.

25. This section provided an overview of the importance of socio-cultural awareness when implementing a transitional shelter approach, offering possible questions for consideration to ensure a culturally appropriate response. The following section continues with key considerations for shelter design in order to minimise risk to the affected population.

1

definition

definition of TS  
10 TS principles  
5 characteristics  
when not to use TS  
SWOT

2

tool

decision-making tool

3

programme

coordination  
programme plan  
assessment  
beneficiaries  
labour  
materials  
procurement  
support  
quality assurance

4

site

community  
site selection  
site planning  
land tenure  
handover

5

design

socio-cultural  
minimise risk  
climatic design  
materials  
construction

resources



## 5.2

# DESIGNING TO MINIMISE RISK

### Introduction

26. This section offers basic guidance on risk reduction techniques which may be integrated when designing transitional shelters with communities. Information is divided according to natural hazards, health considerations, safety and security. Details on minimising risk through site planning and preparation are included in »4.2.

### Learning from local construction techniques

27. Local construction techniques and typologies will provide further insights into safe and appropriate shelter design for the specific nature of the affected area. Local builders may have many valuable insights into designing to minimise risk.

## 5.2.1

### NATURAL HAZARDS

#### Hazard resistance versus hazard resilience

28. Ideally, shelters would resist all hazards, however, this is both impractical and costly. As with all construction worldwide, resistance to hazards must be based upon an assessment of the probable level of risk. The hazards to be designed for, and the level of risk shelters should withstand, are agreed by government and the mandated humanitarian coordinating body. Meeting these locally agreed standards must involve specialist input, especially from structural engineers.

#### Disseminating DRR techniques

29. Whenever possible, transitional shelter design should be used as a platform for communicating disaster risk reduction techniques. Hazard resilient transitional shelters may have an impact beyond the direct beneficiaries if they are accepted as examples of good building practice in the community. As an example, in an area prone to high winds a transitional shelter design will include fixing roofing securely to trusses and trusses securely to walls. If such fixings are not part of traditional construction and if the value of this is observed by occupants during storms, it may inform parallel reconstruction »1.2, Principle 2, Involve community. Transitional shelter programmes should reduce the vulnerability of the affected population.

#### Multi-hazard assessment

30. Risks often occur as a consequence of a combination of hazards, such as earthquakes causing tsunamis, landslides or fires. Multi-hazard resilient techniques should be considered when designing transitional shelters.

#### Location and mitigation

31. The primary way to reduce risk from any hazard is to locate all transitional shelters away from the hazard. The following mitigation measures should only be considered if the risk is of a level that can be adequately managed using them.



**Alarms, evacuation and access**

32. For all hazards, site planning should take into account the location of alarms, such as a bell or siren, as well as muster points, routes for evacuation and evacuation areas. Access should be possible for emergency services and critical infrastructure, such as bridges, should be strengthened.

**Further information**

33. The guidance provided in this section is not comprehensive, nor are the examples provided suitable for every situation. They are intended as a basic introduction to principles and must be designed by a qualified professional.

**Flood resilience measures**

**Introduction**

34. Transitional shelters are light structures and are therefore particularly susceptible to damage from floods. Flash floods, storm surges and/or rise in groundwater can cause severe damage to buildings and infrastructure particularly with the addition of debris, increased risk of drowning and promote a breeding ground for insects such as mosquitoes. Contact with flood water should be avoided due to contaminants such as sewage. University of Cambridge, 2005. *TSDP*, p.237.

**Foundations and plinths**

35. Elevated foundations, or plinths, may be used to raise the living area above the level of potential flood water. Basic plinths may consist of simple platforms created with of a mix of compacted sand, clay and cement. Cement or other available hard materials should be used to stabilise the plinth sides to help prevent scouring undermining the plinth and foundations. The plinth level should exceed the maximum flood level, as shown in Diagram 5.1. >>5.5.1

**Diagram 5.1**  
**Elevated plinth**

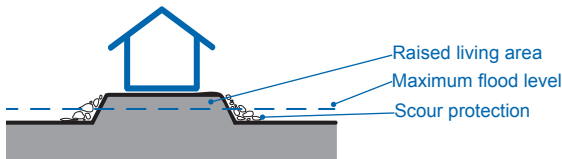

Adapted from Practical Action, *Document Library* [online].

**Designing the shelter to flood**

36. As an alternative to raising the entire structure, in slow-onset floods the shelter may be designed to allow flood water to run through. This approach ensures that expensive parts of the shelter, the foundations, structure and roof, are saved. This approach is not appropriate if the flood is likely to be fast moving, or if it is likely to carry with it a significant amount of water-borne debris, as the shelter is more likely to be destroyed. Careful consideration will be needed when water pressure against the roof can result in the failure of the structure. Foundations should be designed to withstand the water pressure and impacts from debris, understanding that the pressure exerts greater leverage the deeper the flood water is. Sacrificial wall panels may be designed to wash away, which requires them to be fixed in panels between columns, rather

1

definition of TS  
10 TS principles  
5 characteristics  
when not to use TS  
SWOT

definition

2

decision-making tool

tool

3

coordination  
programme plan  
assessment  
beneficiaries  
labour  
materials  
procurement  
support  
quality assurance

programme

4

community  
site selection  
site planning  
land tenure  
handover

site

5

socio-cultural  
minimise risk  
climatic design  
materials  
construction

design

resources

than spanning columns. Storage areas may be created in the roof space between the truss ties and rafters so that, as the flooding starts, occupants may save possessions that they are unable to carry with them.

**Designing masonry shelters to flood**

37. If masonry construction is used during the transitional shelter process, walls may be waterproofed to the height of predicted flood levels. Basic construction materials may include stone or fired brick with cement mortar, ideally plastered from ground level to the predicted maximum flood level. Above the predicted water level other, non flood resistant materials may be used. To prevent moisture rising through the structure, the structure may need to incorporate a damp-proof membrane (DPM) under the floor and a damp-proof course (DPC) within the wall at the upper limit of flood resistant material use.



5.6 Plastering to protect external walls from flood risk, Pakistan IOM Pakistan.

38. Diagram 5.2 shows the use of a fired brick foundation wall to protect the lower part of a wall from flood water and rising damp.

**Diagram 5.2 Improving foundation waterproofing**

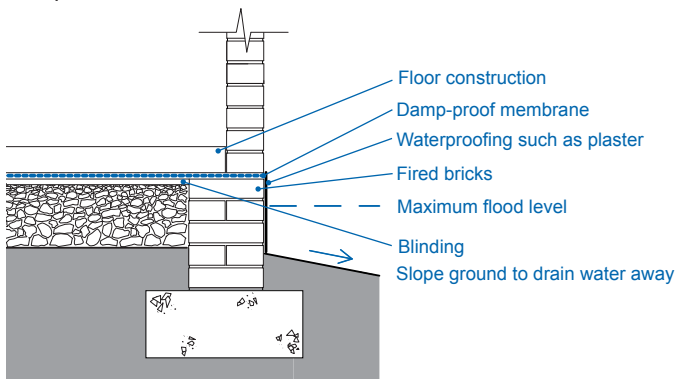



## Designing raised shelters on stilts

39. If flooding is regular and the waters are high but slow and are unlikely to carry debris that may cause major damage, consideration should be given to developing shelters raised up onto columns or stilts. Challenges with this approach may include:

- ▶ major implications for the use of the shelter culturally and in daily life;
- ▶ affected population may not be familiar with the required method of construction;
- ▶ increased complexity and cost of construction, also requiring careful structural engineering and quality assurance; and
- ▶ difficulties in upgrading and extending the structure, as an incremental process.

40. One opportunity would be the introduction of a new approach to reducing risk which may be adopted more widely in reconstruction.

### Landslide resilience measures

#### Introduction

41. Landslides, including rock falls, tree slides, mud slides and avalanches, are often the result of deforestation or overgrazing or in areas prone to wildfire. Heavy rainfall may trigger these events on steep slopes. Mining and excavation works can also affect the stability of slopes. Such “mass movements” can cause extensive building damage and/or loss of life. 📖 University of Cambridge, 2005. *TSDP*, p.230–231.

#### Retaining walls and engineering

42. If relocation is not feasible, it may be possible to mitigate the risk through building walls and other engineering works. This is usually at high cost and specialist engineering input is required, as not all landslide risks can be managed sufficiently.

#### Adequate drainage

43. Saturated ground can increase the possibility of landslides. Adequate drainage measures surrounding the shelter can help to mitigate this. »4.2

#### Foundations and plinths

44. Foundations which extend below the region of ground movement may assist building stability. However, these may not be appropriate or possible within a transitional shelter approach. »5.5.1

#### Openings

45. Openings within walls should always be reinforced. Where only small landslides are likely, openings that are orientated towards the potential source should be minimised. However, openings away from the potential source may be larger to allow for safe evacuation. »5.5.3

#### Multi-hazard resistance

46. Landslides can occur as a consequence of other major hazards such as earthquakes, storms and flooding, therefore multi-hazard resistance techniques should be considered when designing transitional shelters.

1

definition of TS  
10 TS principles  
5 characteristics  
when not to use TS  
SWOT

definition

2

decision-making tool

tool

3

coordination  
programme plan  
assessment  
beneficiaries  
labour  
materials  
procurement  
support  
quality assurance

programme

4

community  
site selection  
site planning  
land tenure  
handover

site

5

socio-cultural  
minimise risk  
climatic design  
materials  
construction

design

resources

## Earthquake resilience measures

### Introduction

47. Earthquakes can cause acute ground shaking resulting in liquefaction (where a soil's strength is reduced and it behaves as a liquid), formation of cracks and/or significant rise and fall of land. Significant damage to buildings and infrastructure may occur which, at worst, may be irreparable and result in fatalities.  University of Cambridge, 2005. *TSDP*, p.226.

### Simple building layout plans

48. Simple building layout plans are recommended for future upgrades and extensions. Asymmetrical, L-shaped, H-shaped or T-shaped designs are more vulnerable and should be avoided.

49. Diagram 5.3 shows the use of simple building plans to improve earthquake resilience.

### Diagram 5.3 Earthquake resilient building plan layouts

#### Earthquake resilient building layout

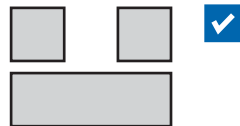
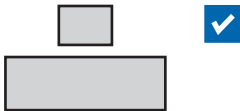
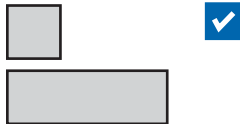

#### Earthquake prone building layout

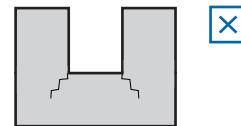
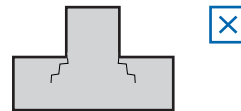
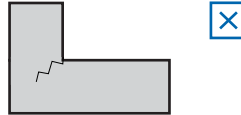

Adapted from  University of Cambridge, 2005. *TSDP*, p.228.

50. If more complex building plans are required, the elements should be structurally independent to reduce the risk of earthquake damage.

### Foundations

51. If possible, foundations should be deep, carefully constructed and well connected to the rest of the structure.   
»5.5.1

### Reinforced walls

52. Construction of thin, high or long masonry walls should be avoided or reinforced with buttresses at regular intervals. Construction techniques, such as reinforced concrete frames, or confined masonry can improve earthquake resilience.   
»5.5.3

<b>Diagonal bracing</b>	53. Diagonal bracing in non load-bearing walls will help to resist lateral earthquake loads. However the bracing should be well connected to the main structure in order to be effective. »5.5.3
<b>Ring beams</b>	54. If possible, ring beams should be placed above the floor level, at lintel level, and below the eaves to increase structural integrity.
<b>Position openings away from corners</b>	55. Doors and windows should be positioned away from corners, and large openings (over approximately 100cm) should be avoided.
<b>Avoid heavy roofs</b>	56. Heavy roofs should be avoided as they can cause injury on collapse. Heavy loads on rooftops should also be avoided, for example multiple layers of mud or soil for insulation over a flat roof, and equipment such as water tanks. »5.5.4
<b>Light roofs</b>	57. Light roofs such as corrugated galvanised iron (CGI) sheeting over a timber frame, are less likely to cause injury on collapse. This type of roof construction lacks thermal insulation however, and so additional materials may be required depending on the climate. »5.3, »5.5.4
<b>Connections</b>	58. All connections should be reinforced. This can be done by using straps, braces or gussets. More in-depth construction principles including using local materials, NFIs and building techniques can be found in »5.4, »5.5 59. Beam connections should be well secured, for example with a long lap or scarf joint in the case of timber. »5.4.2
	<b>Storm resilience measures</b>
<b>Introduction</b>	60. Wind storms, tropical cyclones, tornadoes, lightning, precipitation, dust clouds and extreme temperatures can cause extensive building damage particularly if there are no early warning systems. 📖 University of Cambridge, 2005. <i>TSDP</i> , p.232.
<b>Site layout and vegetation</b>	61. Shelters arranged in clusters may dissipate wind forces more effectively than when arranged in rows, which can amplify the wind's strength. Vegetation may be used to provide a buffer against high winds, however, the danger of falling trees should be considered. 📖 UNEP and SKAT, 2007. <i>After the Tsunami</i> , p.22.
<b>Foundations to withstand uplift</b>	62. Foundations should be sufficient to ensure that shelters are able to withstand uplift forces in strong winds. Shelters which are not properly attached to their foundations may be lifted off the ground. Shelters should be designed with windows which can be closed tightly, to prevent wind entering and adding to uplift. »5.5.1

1

definition of TS

10 TS principles

5 characteristics

when not to use TS

SWOT

2

decision-making tool

3

coordination

programme plan

assessment

beneficiaries

labour

materials

procurement

support

quality assurance

4

community

site selection

site planning

land tenure

handover

5

socio-cultural

minimise risk

climatic design

materials

construction

definition

tool

programme

site

design

resources

63. Diagram 5.4 shows the purpose of anchoring to withstand possible uplift.

**Diagram 5.4**  
Anchoring to foundations to prevent uplift

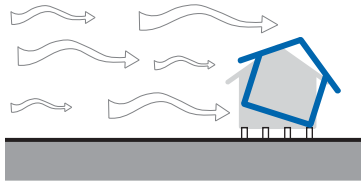

Foundations should be designed and constructed so that the shelter is adequately anchored to the foundation and ground.

Adapted from University of Cambridge, 2005. *TSDP*, p.236.

**Pitch and orientation of roofs**

64. Roofs should be appropriately pitched, oriented and fastened in order to reduce the opportunity for detachment during strong winds. Roof pitches in cyclone prone areas should be at least 30 degrees, ideally 30 degrees–45 degrees. In areas at severe risk of storms, hipped roofs may be considered, however in most cases, hipped roofs are likely to be too expensive and/or complicated for use in transitional shelters. » 5.5.4, University of Cambridge, 2005. *TSDP*, p.234–235.

65. Diagram 5.5 shows considerations for the orientation of pitched and hipped roofs.

**Diagram 5.5**  
Roof shape and orientation

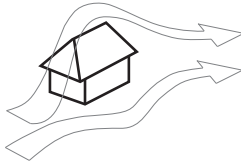

Well connected hipped roofs are more resistant to high winds than gable roofs; a hip-roofed shelter with squared plan is an ideal design in hurricane prone areas. A vented roof will be less prone to uplift.



If gable roofs are used they should be strongly fixed and oriented so that the ends are not facing into the dominant wind directions. They also provide a useful wind shadow.

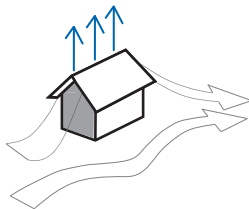

Gable end walls facing the prevailing wind are more prone to damage or collapse, especially if not properly braced and anchored. This can result in damage to the roof, especially from uplift.

Adapted from University of Cambridge, 2005. *TSDP*, p.233.

<b>Reduce overhangs to limit uplift</b>	<p>66. Excessive roof overhangs should be avoided in areas of high winds, as a large overhang can increase the risk of roof detachment. Short or detachable overhangs may be used to reduce the risk of damaging the shelter's primary structure. &gt;5.5.4</p>	<p>1 definition of TS 10 TS principles 5 characteristics when not to use TS SWOT</p>
<b>Hurricane fixings, strapping and cross bracing</b>	<p>67. Roof covering materials must be fixed to trusses, and trusses to walls with fixings such as bolts, screws and straps. Metal strapping and extra bracing is important in high winds, and is particularly important at the roof-wall connections and roof edges to resist uplift forces. &gt;5.5.4</p> <p>68. The edges of the roof are subject to much higher wind forces, therefore the connections of roofing material need to be able to withstand stress, such as by increasing the number of screws and straps used. Failure at any of these locations may lead to complete roof failure.</p>	<p>2 decision-making tool</p> <p>3 coordination programme plan assessment beneficiaries labour materials procurement support quality assurance</p>
<b>Vents</b>	<p>69. Wind vents positioned close to the ridge of a roof will help to balance the internal and external pressures and facilitate natural ventilation.</p>	
<b>Glazing</b>	<p>70. Shutters should be considered to provide protection for glazed windows.</p>	
	<b>Tsunami resilience measures</b>	
<b>Introduction</b>	<p>71. Tsunamis are waves caused by the displacement of large bodies of water and are often as a result of other natural events such as earthquakes. They and the debris they carry can cause extensive damage to buildings and infrastructure particularly in coastal areas or low lying ground.</p>	<p>4 community site selection site planning land tenure handover</p>
<b>Relocation</b>	<p>72. A transitional shelter design is unlikely to offer complete protection against a tsunami. Wherever possible, the community should be relocated away from the hazard.</p>	
<b>Vegetation</b>	<p>73. Trees and bushes can reduce the effect of tsunamis. Mangroves, swamps and other vegetation, which may provide a natural barrier to coastal areas, should be protected.</p>	
<b>Raised shelters and suspended floors</b>	<p>74. In the absence of naturally high ground shelters may be elevated and/or utilise suspended floors to ensure structures are more able to resist the water pressures of a tsunami. Shelters raised on stilts are, however, still vulnerable to being damaged by floating debris. &gt;5.5.2</p>	<p>5 socio-cultural minimise risk climatic design materials construction</p>
<b>Orientation of openings</b>	<p>75. Major openings should be incorporated in elevations facing the sea/ocean to allow water to flow through the shelter reducing high pressure on walls.</p>	
<b>Design for multiple hazards</b>	<p>76. Locations which are at risk of tsunamis are also likely to be prone to earthquakes and floods. Multi-hazard design is therefore advisable when designing transitional shelters.</p>	<p>resources</p>

## Volcano resilience measures

- Technical expertise** 77. Authorities and professionals such as geologists and volcanologists may need to be consulted when building in volcanic areas. »4.3
- Relocation** 78. A transitional shelter design is unlikely to offer sufficient protection from a volcanic eruption. Wherever possible, the community should be relocated away from the hazard.
- Openings and escape routes** 79. Openings, especially doors, should be placed on elevations orientated away from the volcano so that they can be used as escape routes. Large openings on the elevations facing the volcano should be avoided and walls and roofs strengthened, in order to offer a level of protection from blasts and ballistics such as rocks and fragments of petrified lava.
- Roofs and volcanic ash** 80. Roofs may need to be designed to withstand the load of heavy layers of ash. Ash becomes considerably heavier after rainfall, due to saturation.
- Design for multiple hazards** 81. Volcanic eruptions can cause other hazards such as earthquakes, landslides, fire, floods and tsunamis. Multi-hazard resilience should therefore be considered when designing transitional shelters.

## 5.2.2 HEALTH CONSIDERATIONS

- Vector control** 82. The term “vector” is used to describe any organism which can carry disease from one place to another. Two main categories of vector need to be considered when designing transitional shelters:
- ▶ insects such as mosquitoes, fleas, ticks and sand flies; and
  - ▶ small animals such as rats, birds and monkeys.
- Appropriate design measures** 83. Shelters should aim to be resistant to vectors, particularly to mosquitoes in malarial regions. Ideally the whole structure will be resistant, however, if this isn’t possible, the sleeping area should be prioritised. This may be achieved through the provision of treated mosquito nets or the use of netting or fine wire mesh to reduce the entry of insects through window openings and/or doors. Surrounding vegetation, standing water and walls or roof spaces may be sprayed with insecticide. Care should be taken and specialist guidance employed when selecting and using insecticides to ensure appropriate use. 📖 University of Cambridge, 2005. *TSDP*, p.222.
84. The design of transitional shelters should prevent the entry of crawling insects, for example with the use of baseboards at floor to wall connections 📖 Shelter Centre, 2010. *Transitional Shelter Standards (TSS)*, p.17. Holes within shelter materials and at poor connections points can be filled with mortar or other such materials.

**Rodent-resistant “screens”**

**Diagram 5.6**  
**Rodent-proofing measures**

85. Where raised floors are to be used, particularly in flood-prone areas, “screens” can be used to further prevent the entry of rodents and large insects. This is illustrated in Diagram 5.6.

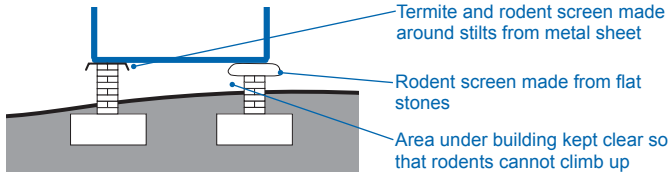

Adapted from University of Cambridge, 2005. *TSDP*, p.223.

**Air quality for cooking and heating**

86. Basic stoves and three-stone fires are used by approximately half of the population of the world, resulting in increased indoor air pollution through the burning of biomass fuel. An estimated 1.5 million deaths a year are attributed to such cooking practices and therefore it is an extremely important consideration when designing transitional shelters. Practical Action, 2007. *Chimney Stoves and Smoke Hoods*, p.1.

87. Shelter design can reduce the risk of smoke inhalation by:
- ▶ improving rudimentary systems through the introduction of flues and chimneys, smoke hoods, or chimney stoves;
  - ▶ improving shelter ventilation;
  - ▶ encouraging improved maintenance of cooking facilities and appropriate practices such as ensuring fuel wood is dry;
  - ▶ using “cleaner” fuel in order to reduce carbon emissions;
  - ▶ reducing the need for fire through various techniques such as “hay boxes”; and
  - ▶ removing or reducing the need for such stoves by better utilisation of natural sources of heat such as solar water heaters and cookers, in combination with improved insulation and efficient use of thermal mass.

Adapted from Warwick, H. and Doig, A, 2004. *Smoke—The Killer in the Kitchen*, p.13–20.

**Toxic environments and substances**

88. Toxic materials such as asbestos, some paints and formaldehyde should be avoided. Any asbestos already on site should be contained or removed. Asbestos poses the greatest risk to health when it is brittle and breaks into small pieces due to extended wear or degradation. University of Cambridge, 2005. *TSDP*, p.221, ProAct network and Shelter Centre, 2009. *Asbestos In Emergencies*.

1

definition of TS  
10 TS principles  
5 characteristics  
when not to use TS  
SWOT

2

decision-making tool

3

coordination  
programme plan  
assessment  
beneficiaries  
labour  
materials  
procurement  
support  
quality assurance

4

community  
site selection  
site planning  
land tenure  
handover

5

socio-cultural  
minimise risk  
climatic design  
materials  
construction

definition

tool

programme

site

design

resources



## 5.2.3 FIRE PREVENTION

### Fire prevention in site planning

89. In areas prone to forest fires or in particularly hot climates, prevention methods should be considered during site planning, for example with the use of firebreaks and the integration of escape routes.



### Field experience: Somalia conflict, 2008—The potential risk of fire

Somalia has remained without a central government since 1991. Civil war and factional fighting alongside weather events such as periods of drought have led to approximately 560,000 refugees and an estimated 1.5 million IDPs. Different shelter programmes have been implemented across Somalia. A range of potential risks can be identified with regard to the specific nature of the region. For example, settlements in Bosaso have seen outbreaks of fire due to an exceptionally hot climate, low levels of rainfall and overcrowding. Design to minimise risk of fire has included site layout considerations, improvements to sanitation, the use of firebreaks, shelter material selection and specific construction techniques. 📖 UN-HABITAT and IFRC, 2010. *Shelter Projects 2009*, p.20.

### Fire safety distance

90. If possible, distance between shelters should be at least twice the height of the structure, in order to reduce the risk of fire spreading. This is shown below in Diagram 5.7. This distance should be increased to three or four times the height if buildings are highly flammable. In locations where there is limited space, emphasis should be placed on the selection of non-flammable materials. The impact of wind and prevailing wind direction may also affect fire safety distances. 📖 UNHCR, 2007. *Handbook for Emergencies*, p.219.

Diagram 5.7  
Fire safety distance

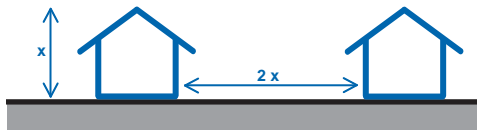

Suggested safe fire distance. This distance should be increased if buildings are highly flammable.

Adapted from 📖 University of Cambridge, 2005. *TSDP*, p.224.

### Material considerations

91. If shelters are built with potentially flammable materials such as straw thatch and timber, the distance between shelters should be three to four times the height of the structure, if possible. 📖 UNHCR, 2007. *Handbook for Emergencies*, p.219.

92. Special attention must be paid to fire- and heat-proofing the floor and walls under and around stoves and heaters.

### Alarms, evacuation and fire fighting

93. Site planning should take into account the location of alarms, such as a bell or siren, as well as evacuation routes and provision for the accommodation and access of fire fighting equipment and teams.

## 5.2.4 SECURITY

- Household security** 94. The design of a transitional shelter affects the security of the occupants, as well as their dignity and privacy.
- Locks** 95. It may be necessary to provide locks for doors and windows, or to design shelters such that locks can be added. However, the entire design should be considered with regard to security for example, locks on windows and doors may be ineffective on shelters with plastic sheeting or fabric walls, as these can be easily cut.
- Exits** 96. Shelter design should include more than one exit route in order to provide an escape route in case one exit becomes blocked. Where locks are installed, care should be taken to ensure that the doors are easy to unlock from the inside.
- Visual privacy** 97. Shelter walls should prevent people outside from being able to observe whether or not the shelter is occupied. It must therefore be possible to cover doors and windows, as well as light the shelter at night without creating silhouettes. >>5.1.1
- Conflict** 98. If a transitional shelter programme must be located in an area at risk of further conflict, care should be taken with regard to adjacent conflict-damaged buildings or abandoned posts which may include unexploded munitions.
- Dialogue with community** 99. Dialogue with the local community regarding the possible risks and hazards of the particular site is advisable. All sources of information should be investigated. 📖 University of Cambridge, 2005. *TSDP*, p.217–219.
100. This section offered basic principles to consider when designing a transitional shelter programme, giving specific attention to issues related to minimising risk. The following section offers guidance of climatic design.

1

definition of TS  
10 TS principles  
5 characteristics  
when not to use TS  
SWOT

definition

2

decision-making tool

tool

3

coordination  
programme plan  
assessment  
beneficiaries  
labour  
materials  
procurement  
support  
quality assurance

programme

4

community  
site selection  
site planning  
land tenure  
handover

site

5

socio-cultural  
minimise risk  
climatic design  
materials  
construction

design

resources

101. Designing transitional shelters in response to the local climate increases the performance of the building in keeping the occupants comfortable and minimises environmental impacts over the lifespan of the shelter, by reducing the need for cooling or heating. Passive and bioclimatic design techniques are integrated into the transitional shelter programme in order to respond to the specific nature of the climate without increasing energy demand.

102. The outdoor climate over the year is generally regarded as the “given condition”, however, the effect of climate change should be considered if significant. 📖 Rosenlund, H., 2000. *Climatic Design of Buildings Using Passive Techniques*, p.5.

103. As with other technical chapters in this guideline, the following section does not give comprehensive advice and is intended to promote the involvement of specialists through an awareness of the importance of the topic, rather than enabling non-specialists to undertake the tasks involved.

104. The section presents an overview of key considerations for temperature, humidity and ventilation within three typical climate types: warm-humid, hot-dry and cold.

### 5.3.1 INTERNAL CONDITIONS

#### Temperature

##### Introduction

105. The effect of both daily and annual temperature variation on the internal conditions of a transitional shelter should be considered. Diurnal temperature variations are typically greatest in hot-dry areas such as deserts at high altitude in comparison to low-lying humid areas. Extreme temperature differences can also be experienced from season to season. As the period of securing land tenure and reconstruction may take a number of years it is therefore essential to assess available meteorological data to ensure shelter design is suitably appropriate.

##### Comfort factor

106. Comfort is subjective and it is therefore difficult to specify “optimal comfort”. Instead, “comfort zones” can be defined for specific climates using a range of indices such as the corrected effective temperature (CET) and operative temperature (OT). Factors affecting personal thermal comfort include environment, for example air temperature, and other contributing factors, such as clothing, age, health and diet. 📖 Auliciems, A and Szokolay, S.V, 2007. *Thermal Comfort*, p.8.

**Factors affecting temperature**

107. It is worth noting that local populations are typically acclimatised to the specific nature of the climate, resulting in “comfort zone” parameters that may vary from those for non-local populations. 📖 Auliciems, A and Szokolay, S.V, 2007. *Thermal Comfort*, p.8.

108. The temperature within a transitional shelter will be affected by the:

- ▶ outside temperature;
- ▶ level of insulation;
- ▶ thermal mass of shelter materials;
- ▶ ventilation strategies;
- ▶ number of building occupants; and
- ▶ use of heat emitting sources such as stoves and heaters within the shelter.

**Humidity**

**Introduction**

109. Relative humidity is the amount of water vapour in the air, with 100% saturation classified as “absolute”. Hotter air can contain more water than colder air. When the dew point is reached, excess water condenses on the surface of cooler materials.

110. In both hot and cold climates, moisture creates conditions for fungi, mould and mildew, which affect health, building materials, bedding and clothing. It is also necessary to control humidity in hot climates to improve comfort using ventilation; while in cold climates humidity causes condensation, which may additionally reduce the impact of insulation.

**Sources of humidity**

111. Sources of humidity inside a shelter include:

- ▶ ambient relative humidity;
- ▶ water brought into the shelter, for example as rain or snow on wet clothes;
- ▶ building occupants, moisture through breathing; and
- ▶ use of heaters and stoves in the shelter, producing water vapour as a product of combustion.

112. The humidity in a shelter will also be affected by the external climatic conditions, the ventilation strategies within the shelter and the “breathability” of construction materials.

**Ventilation**

**Introduction**

113. Ventilation, both active and passive, is the process of replacing air within a space through exchange with the external environment and circulation within the shelter itself. Successful ventilation strategies can improve air quality.

114. Ventilation directly affects the temperature and humidity within the shelter, as well as the level of comfort through noticeable air movement.

1

definition

definition of TS  
10 TS principles  
5 characteristics  
when not to use TS  
SWOT

2

tool

decision-making tool

3

programme

coordination  
programme plan  
assessment  
beneficiaries  
labour  
materials  
procurement  
support  
quality assurance

4

site

community  
site selection  
site planning  
land tenure  
handover

5

design

socio-cultural  
minimise risk  
climatic design  
materials  
construction

resources

#### Air movement

115. Air movement increases cooling through convective heat loss, where warm air next to the body is displaced by cool air from the environment. It follows that ventilation should generally be maximised in warm climates and minimised in cold climates. However, it is important to consider “comfort levels” to ensure high ventilation rates do not result in the perception of discomfort, for example for populations acclimatised to higher temperatures.

#### Air exchange rate

116. A minimum level of ventilation should be achieved at all times, to ensure sufficient air exchange in a shelter. If shelters are completely sealed, the inhabitants may be at risk of asphyxiation from the lack of oxygen or high levels of carbon monoxide, resulting from their own breath or from heaters or cookers. In addition conditions for mould growth will be created.



5.7 Ventilation techniques, Haiti  Cordaid Haiti.

### 5.3.2

## DESIGN CONSIDERATIONS FOR WARM-HUMID CLIMATES

### Temperature

#### Shading to minimise exposure

117. Direct solar gain should be minimised particularly during the hottest period of the day through the use of shading techniques such as overhangs, external shading devices, use of vegetation, and correct building orientation.

#### Thin walls

118. Lightweight walls are preferable, minimising the thermal mass of the shelter. »5.4, »5.5

### Humidity

#### Reducing water in the shelter

119. Rising damp through capillary action can be prevented from soaking through the floor and walls through the use of a damp-proof membrane, usually a sheet of plastic under the floor, and damp-proof courses a short distance from the base of walls, usually a strip of plastic sheeting. In flood-prone areas and areas subject to heavy rain, design measures should

be considered alongside design techniques to prevent water entering the shelter, for example by raising it on a plinth or on stilts. »5.2.1

**Transpiring materials**

120. Natural “breathable” material choices should be considered to facilitate heat and moisture removal from inside the shelter. For example, walls of lapped timber planks can prevent driving rain from entering the shelter, while the gaps between the laps enable ventilation.

**Measures to prevent condensation**

121. Shelters are at risk of condensation in warm-humid climates, when saturated air trapped inside the shelter during the day condenses at night, as it becomes colder. In cold climates condensation can occur when the hot humid air in a shelter meets the colder surrounding air. Possible methods of reducing condensation are listed below:

- ▶ increase ventilation in a way that does not cause a draught, but cannot be blocked; for example around a flue hole in the roof;
- ▶ provide a covered external area for wet items such as clothes and shoes;
- ▶ consider damp-proof membranes and courses, or raised floors to better protect from rising moisture and direct contact with damp ground;
- ▶ prevent rain water being driven by winds onto outside walls, which saturates wall materials, for example by increasing roof overhangs; and
- ▶ use pitched roofs with appropriate slope gradient to allow water runoff and drainage.

**Interstitial condensation**

122. Interstitial condensation occurs within the wall structure. This can occur when warm, moist air diffuses through a vapour-permeable material to cooler air on the opposite side. If the “dew point” is reached in the material, or if the air reaches a less permeable layer or colder surface, condensation may form.

123. Interstitial condensation is particularly dangerous as it can develop for some time before being detected. It can lead to mould growth which can cause serious structural damage as mould damage to timber and thatch or rust to metal reinforcement and sheeting.

**Methods to avoid interstitial condensation**

124. In warm-humid climates, the provision of adequate ventilation within the shelter should reduce or eliminate the effects of interstitial condensation. Vapour permeable materials can help with ventilation. Other methods, generally more appropriate for temperate or cold climates include using ‘warm roof’ construction (where insulation is located at the roof deck, directly below the waterproof layer) and use of damp-proof membranes and vapour-permeable barriers.

1

definition

definition of TS  
10 TS principles  
5 characteristics  
when not to use TS  
SWOT

2

tool

decision-making tool

3

programme

coordination  
programme plan  
assessment  
beneficiaries  
labour  
materials  
procurement  
support  
quality assurance

4

site

community  
site selection  
site planning  
land tenure  
handover

5

design

socio-cultural  
minimise risk  
climatic design  
materials  
construction

resources

125. Diagram 5.8 shows good and bad practice when ventilating wall cavities to prevent interstitial condensation.

**Diagram 5.8**  
Ventilating wall cavities

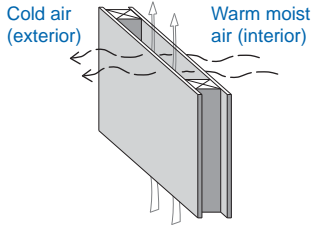

Well ventilated wall cavity prevents moist air condensing inside the wall and prevents interstitial condensation.

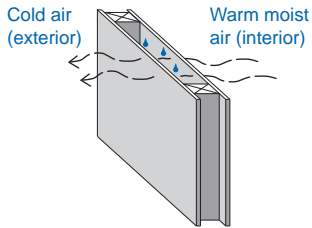

Lack of ventilation in wall cavity means that moist air can condense inside the wall and, as a result, can lead to structural damage.

## Ventilation

### Elevation of shelters

126. Elevating shelters may encourage air flow due to positive and negative pressures.

### Prevailing wind

127. Prevailing wind direction should be considered to maximise the potential for cross ventilation.

### Opening considerations

128. In order to maximise air flow, outlet openings can be positioned higher than inlets. Examples of ventilation openings are windows, grills, louvres, or air bricks. Natural convection currents result in warm air rising. Air will be warmed inside the shelter, causing it to rise, escaping the shelter at high level. Large openings are encouraged.

129. Diagram 5.9 shows some basic principles of cross-ventilation in warm-humid climate and the opportunity to elevate shelters to encourage air movement.

**Diagram 5.9**  
Ventilation principles for warm-humid climates

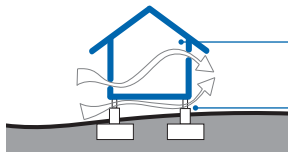

High and low level ventilation gaps on opposite walls encourage air flow.

Shelter on stilts allows air flow underneath thus cooling.

### High ceilings

130. High ceilings increase the volume of air within the shelter encouraging movement of air through convection and buoyancy effects.



Rainwater management

Roof overhangs

### Other considerations

131. Pitched roofs facilitate rainwater drainage. » 5.5.4,  University of Cambridge, 2005. *TSDP*, p.241.

132. Large roof overhangs may provide shading to walls and protection from heavy rains. Extensive roof overhangs should be avoided in areas at risk of high wind, due to the potential for uplift. » 5.2.1



5.8 Upgradable shelter solution for a warm-humid climate, Leogane/Haiti  Mike Meaney/Habitat for Humanity.

## 5.3.3

## DESIGN CONSIDERATIONS FOR HOT-DRY CLIMATES

Orientation

The use of vegetation to minimise exposure

Diagram 5.10 Shading opportunities

### Temperature

133. Successful orientation of shelters with regard to the sun's path across the course of the day and over the period of a year may reduce the impact of direct solar gain.

134. Vegetation may be used to minimise the heat gain of walls during the hottest part of the day. Vegetation also creates a more comfortable microclimate by lowering temperatures through the natural process of evaporative cooling.

135. Diagram 5.10 shows the opportunity to use existing vegetation for shading.

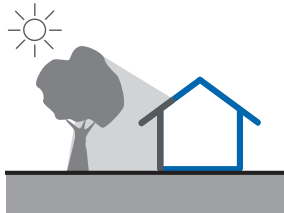

Situating a shelter in the shade of trees or other foliage will result in no direct sunlight hitting and being absorbed by the shelter's thermal mass. In colder conditions, it is beneficial to move the shelter out of shaded areas to maximise solar gain.

1

definition of TS  
10 TS principles  
5 characteristics  
when not to use TS  
SWOT

definition

2

decision-making tool

tool

3

coordination  
programme plan  
assessment  
beneficiaries  
labour  
materials  
procurement  
support  
quality assurance

programme

4

community  
site selection  
site planning  
land tenure  
handover

site

5

socio-cultural  
minimise risk  
climatic design  
materials  
construction

design

resources

**Double-skin roofs**

136. Radiant heat gain can be minimised through double-skin techniques, encouraging ventilation through the roof. 📖 The Sphere Project, 2011, *The Sphere Handbook*, p.261.

**Shade nets**

137. To achieve a similar impact to a double-skinned roof, plastic shade nets may be suspended over the shelter, which allow air to pass through, but greatly reduce the thermal gain by reducing the amount of sunlight that reaches the shelter. 📖 MSF and Shelter Centre, 2006. *Shade Nets*.

**Thermal mass**

138. Thermal mass acts to even out daily temperature variations within a shelter. Materials with high thermal mass can absorb heat from the sun or from internal heat sources such as heaters and stoves, and release it slowly over time. Materials with high thermal mass are often not easily transportable and should, therefore, only be used in transitional shelter designs where temperature variations are extreme, or where they are used traditionally and can be sourced locally.

**Insulation**

139. Insulation can be used to maintain differences in temperature between internal and external conditions. Care should be taken in design, as some hot dry climates become cold at night and when air of different humidity and temperature meet, interstitial condensation occurs. The use of local techniques and natural materials such as thatch, straw, mud, timber panels or fibre board may be suitable, as well as insulation such as glass wool and polystyrene. >>5.4

**Ventilation**

**Elevated site**

140. Elevated sites may facilitate air movement in and around shelters.

**Compact form**

141. Narrow streets and minimum affordable spacing between shelters maximises shading opportunities to offer protection from intense sun, as well as minimising dust blown by wind. Care should be taken to protect against the spread of fire. 📖 University of Cambridge, 2005. *TSDP*, p.242.

**Opening considerations**

142. Ventilation of eaves is recommended to encourage high level cross ventilation and facilitate the release of hot air. Low level inlets allow more effective air circulation however their size should be restricted and gaps between construction elements should be minimised to reduce dust and vector entry. 📖 University of Cambridge, 2005. *TSDP*, p.241.

143. Diagram 5.11 shows basic ventilation principles in hot-dry climates.

**Diagram 5.11**  
**Ventilation strategy for hot-dry climates**

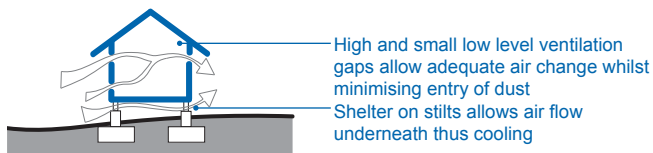

## High ceilings

144. High ceilings increase the volume of air within the shelter encouraging movement of air through convection and buoyancy effects.

## 5.3.4

# DESIGN CONSIDERATIONS FOR COLD CLIMATES

## Orientation

145. Successful orientation of shelters with regard to the sun's path across the course of the day and over the period of a year may provide an opportunity to maximise the use of solar gain to reduce energy demand.

## "Warm rooms"

146. The use of "warm rooms" where it is not necessary to heat the whole shelter can help to reduce fuel use. Provision of stoves and heaters should be considered and fire safety measures implemented accordingly. >>5.2.3

## Thermal mass and insulation

147. High thermal mass and/or substantial insulation are important for maintaining suitable temperatures, and to reduce the shelter's energy demand. Plastic sheeting is often used to limit the infiltration of cold air by stopping draughts. Insulation can also be used to sub-divide the indoor space and create thermal buffer zones, such as a vestibule in front of the door. The use of local techniques and natural materials such as thatch, straw, animal hides, wool, timber panels or fibre board may be suitable, as well as insulation such as glass wool and polystyrene. 📖 University of Cambridge, 2005. *TSDP*, p.240.



**Tip: Up to 50% of heat loss happens through the roof if the shelter is not properly insulated**

148. Diagram 5.12 shows insulation measures that may be adopted.

Diagram 5.12  
Cold climate building principles

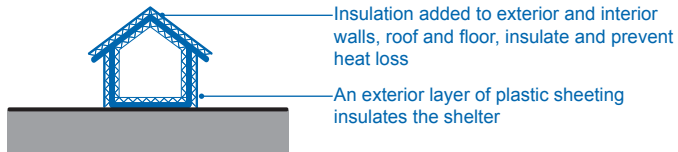

## Compact form

149. A compact form is functional to reduce heat loss in cold climates. Square plans are ideal, however, for transitional shelters appropriately insulated shapes with a maximum ratio of length to width of 3:1 may be more feasible.

## Humidity

## Reducing water in the shelter

150. In cold and temperate climates where insulation is used, vapour checks should be added in walls and roofs, usually made from tarred paper or a "breathable" but waterproof spun polymer. Plastic sheeting may also be used if appropriate.

1

definition of TS  
10 TS principles  
5 characteristics  
when not to use TS  
SWOT

2

decision-making tool

3

coordination  
programme plan  
assessment  
beneficiaries  
labour  
materials  
procurement  
support  
quality assurance

4

community  
site selection  
site planning  
land tenure  
handover

5

socio-cultural  
minimise risk  
climatic design  
materials  
construction

definition

tool

programme

site

design

resources

**Condensation due to occupant activity**

151. Occupants breathe almost a litre of water per person per day into a shelter. Cooking and washing create additional sources of humidity. Again, care should be taken in design, as when air of different humidity and temperature meet, interstitial condensation occurs. »5.3.2

**Ventilation**

**Minimise ventilation**

152. Ventilation should be minimised as air entering the shelter from outside will act to cool the internal space. A degree of ventilation should be ensured at all times to allow sufficient air exchange for the inhabitants. This is particularly important in cold climates where stoves and heaters are commonly used. Shelters which are completely sealed can put inhabitants at risk of asphyxiation, carbon monoxide poisoning and respiratory diseases. »5.2

**Other considerations**

**Snow loads**

153. Roof structures should be designed with adequate resistance to sustain potential snow loading. Overhanging eaves should be integrated to protect walls from moisture caused by falling snow and rain. Adequate drainage or raised floor construction may be required to reduce the risk of water from snow melt entering the shelter. »5.5.4,  The Sphere Project, 2011. *The Sphere Handbook*, p.261.

154. The content provided in this section presents basic principles of climatic design. The aim is to create an understanding of appropriate material choices and construction techniques, which are presented in greater detail in the following sections.

## 5.4

# BUILDING MATERIALS

**155.** This section provides basic information on common materials that may be suitable for use in transitional shelter construction, emphasising the importance of local traditional building techniques and materials.

**156.** Developing a transitional shelter programme around local traditional building techniques and materials will increase its appropriateness, efficiency in terms of cost and speed of construction, and durability. Changes introduced through a programme, such as increasing risk reduction, will be more likely to be adopted sustainably as local construction techniques.



### Case study: Peru earthquake, 1990—Improved quincha technology

In May 1990 the Alto Mayo region of northern Peru was struck by an earthquake resulting in extensive damage to approximately 3,000 houses. Taking precedent from traditional construction with inherently flexible structures, Practical Action worked with local communities to introduce an improved earthquake resistant building technology known as *quincha mejorada*.

The 70 houses constructed with this technique withstood a second tremor in April 1991 to such a degree that *quincha mejorada* has now been adopted by the mainstream building trade in the area, resulting in the construction of a further 4,000 houses to date. Practical Action, *Quincha Earthquake-resistant Housing* [online].



5.9 Quincha mejorada, Peru Practical Action Latin America.

1

definition of TS  
10 TS principles  
5 characteristics  
when not to use TS  
SWOT

definition

2

decision-making tool

tool

3

coordination  
programme plan  
assessment  
beneficiaries  
labour  
materials  
procurement  
support  
quality assurance

programme

4

community  
site selection  
site planning  
land tenure  
handover

site

5

socio-cultural  
minimise risk  
climatic design  
materials  
construction

design

resources

## 5.4.1

# LOCAL CONSTRUCTION TECHNIQUES AND MATERIALS

**The importance of understanding traditional techniques and materials**

157. Local construction techniques and use of materials are indicators to understand local cultures and their adaptation to their environment and available resources. These techniques evolved over a long period, establishing balanced relationships between how the community lives, the process of construction and the surrounding environment.

**Adaptation features**

158. Local construction techniques adapt to factors such as climatic features, topography, access to water, access to materials, constantly adjusting to changes in circumstances. Through assessing these local construction methods, it is possible also to form an understanding of how a community perceives hazards and vulnerability; its relationship with resources and the environment; but also cultural factors, such as ways of using public space and social interaction patterns.

159. In most parts of the world, local construction techniques and use of materials have changed significantly during the last century, with the introduction of materials such as corrugated galvanised steel sheeting.

**Poor construction techniques**

160. The rapidity of these changes often led, however, to poor construction techniques using the new materials. For example, often concrete blocks use poor materials and are cured badly; concrete is often used without engineering calculations and insufficient reinforcement; linkages and joints such as column heads may be built with little understanding of structural continuity with floor slabs; and roofing sheets may be used without sufficient fixing to secure them against high winds.

**Understanding local attitudes**

161. These recent changes are also very valuable to learn from, rather than trying to refer only to a particular tradition from another period. Recent changes also reflect the aspirations of some cultures to exhibit modernity and wealth. Equally, some cultures may use older techniques and materials to exhibit their traditional aspirations. In learning from both older and more recent construction and materials, the lessons from each will form a profile of a community that will range from their risk reduction techniques to their attitudes to vulnerable groups.

162. An understanding of local construction techniques and materials must therefore be formed in order to inform the transitional shelter and parallel reconstruction processes. Transitional shelter construction and material use should be as similar as possible to local construction techniques and materials. Differences should occur only either if sufficient local materials cannot be sourced locally or regionally, requiring the importation of materials such as plastic sheeting; or if risk reduction measures require new techniques, such as the introduction of cross-bracing and hurricane straps.



## Case study: Uganda, 2007—Shelter improvement

Houses were damaged and crops destroyed due to slow onset floods, following heavy rains in the east of Uganda. In order to rebuild more flood resistant shelters, communal and individual tool kits were distributed. A fundamental aspect of this approach was community mobilisation. Regarding construction techniques a simple solution was adopted, based on simple improvements to traditional construction. The main approach to construction was to refer to traditional techniques as a strong point, improving them over time in order to build more flood resistant shelters. 📖 UN-HABITAT and IFRC, 2010. *Shelter Projects 2009*, p.79.

1  
definition of TS  
10 TS principles  
5 characteristics  
when not to use TS  
SWOT

definition

2

decision-making tool

tool

3

coordination  
programme plan  
assessment  
beneficiaries  
labour  
materials  
procurement  
support  
quality assurance

programme

4

community  
site selection  
site planning  
land tenure  
handover

site

5

socio-cultural  
minimise risk  
climatic design  
materials  
construction

design

resources

### 5.4.2

## COMMON CONSTRUCTION MATERIALS

163. The following content gives an overview of some common building materials. It is important to clarify that some of these may be included as part of packages of shelter NFIs that are distributed in the early emergency stage, and may be used as part of the construction of a transitional shelter. 📖 IASC, 2008. *Selecting NFIs for Shelters*.

### Plastic sheeting

164. Plastic sheeting is usually distributed in the early stages of an emergency, mainly as part of a shelter NFI package. These packages include materials and tools that allow people to build and cover a structural frame for a shelter. 📖 IASC, 2008. *Selecting NFIs for Shelters*.

165. There are three basic types of plastic sheeting:

- ▶ plastic sheeting made to the UNHCR/MSF specification (white, or white with reinforced coloured stripes); 📖 UNHCR, 2007. *Handbook for Emergencies*, p.440.
- ▶ heavyweight sheeting, used for roofing and sometimes as a damp-proof course (sometimes orange and grey); and
- ▶ window sheeting (translucent usually reinforced with a net of polyester filaments).

166. Care should be taken not to procure and distribute sub-standard sheeting. Although such sheeting may be easier to procure and cheaper, its durability is considerably reduced, as is its flexibility of use: it will be difficult to fix without tearing and may need further materials to be effective, for example by sandwiching it between mats to reduce ultraviolet (UV) degradation and tearing.

Plastic sheeting as part of a NFI package

Basic types of plastic sheeting

Sub-standard plastic sheeting



167. Diagram 5.13 shows good and bad practice for fixing plastic sheeting.

**Diagram 5.13**  
**Plastic**  
**sheeting**  
**connection**  
**details**

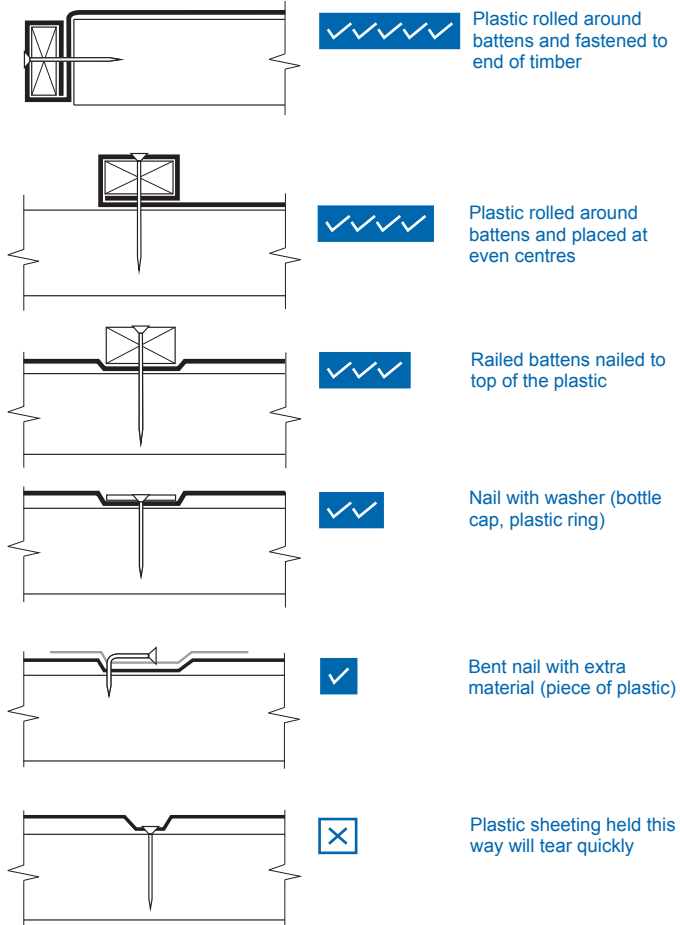

**The size and**  
**number of**  
**sheets**

168. The size and number of the plastic sheets distributed to each household should be agreed at local or response level through technical working groups of the coordination body, so that distributions are appropriate and equitable. Plastic sheeting is a common material in the first distribution supporting transitional shelter. Depending upon circumstances, distributing a 4m x 7m sheet may be more useful to the household for both their immediate shelter and later as part of the transitional shelter design agreed than distributing a 4m x 5m sheet. For this reason plastic sheeting should be imported, to the UNHCR/MSF specification, in rolls which are normally 4m x 50m. Sheets should then be cut from the roll in-country or on site.

## Cutting and fixing

169. When cutting and fixing plastic sheeting, special care has to be taken, in order to optimise its durability and minimise tearing. Cutting tools may be included in the distributed NFI pack.

170. When fixing plastic sheeting, the following should be considered:

- ▶ prevent tearing from the fixing points;
- ▶ stop the sheeting flapping about and degrading, by fixing it so that it is tight like a drum-skin;
- ▶ prevent tearing by ensuring a minimum number of wear points under the plastic; and
- ▶ prevent the accumulation of rainwater on roofs that could lead to pooling and an increase of weight over the roof structure.

Adapted from  University of Cambridge, 2005. *TSDP*, p.320.

## Corrugated galvanised iron (CGI)

171. The term “CGI sheets” describes corrugated galvanised steel sheets commonly used in construction. The main advantages of CGI sheets are that they are lightweight, cheap, fast to build with and easily transportable. They are made from galvanised steel that has been cold-rolled through a machine in order to give it a corrugated profile. This process increases their bending strength perpendicular to the corrugations. CGI sheets are specified by thickness (gauge). Thicker sheets are stronger and last longer. It is important to specify the correct gauge.

172. However this material also presents some disadvantages, mainly regarding the fact that it does not insulate from heat or cold. Regular replacement is also necessary due to its tendency to rust, however, this is in part determined by the quality of sheeting and its fixing. Adapted from  MSF Spain, 2011. *Small Constructions Manual*, p.44,

## Application of CGI

173. The application of the corrugated iron sheets is done by bolting, screwing or nailing them to a supporting structure. In areas with high winds, additional fixing as needed throughout the roof, and especially on edges.

174. CGI is used on pitched roofs and in order to achieve waterproofing it is necessary to place them overlapping by two corrugations in the lateral direction and a minimum of 15cm in the longitudinal direction for a pitch of 35 degrees, however this overlap will need to be increased for lower pitched roofs or in areas of driving rain. It is advisable to consider the use of extra insulation against heat and cold, such as a suspended ceiling fixed under the trusses with a ventilated roof space. Adapted from  MSF Spain, 2011. *Small Constructions Manual*, p.44.

1

definition of TS

10 TS principles

5 characteristics

when not to use TS

SWOT

2

decision-making tool

3

coordination

programme plan

assessment

beneficiaries

labour

materials

procurement

support

quality assurance

4

community

site selection

site planning

land tenure

handover

5

socio-cultural

minimise risk

climatic design

materials

construction

definition

tool

programme

site

design

resources



5.10 Roof fixing, Haiti 📷 David Sacca/Handicap International.

175. Diagram 5.14 shows good and bad practice of fixing CGI to roof timbers.

Diagram 5.14  
Fixing CGI  
sheeting

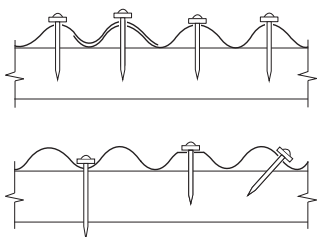

Fixed securely:  
At least one lap at the connection  
with appropriate nail at top  
corrugation to prevent leakages.



Inadequate fixing:  
Connection is not secure, CGI is  
damaged and prone to damage  
or leakages in winds.

176. Diagram 5.15 shows common roof construction details with CGI.

Diagram 5.15  
CGI sheeting  
details

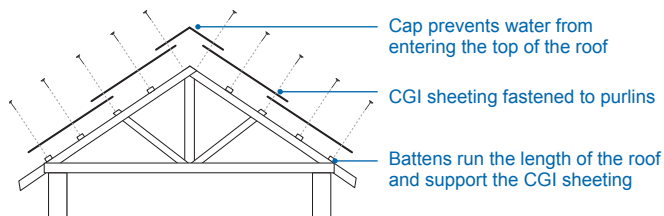

### Timber and bamboo

177. Sawn timber, round poles, bamboo and composite materials using wood or bamboo, such as panels, are used frequently in transitional shelter designs, given their common use in local construction techniques, availability, lightness to transport, ease of use in construction, suitability for use in frame structures, and suitability to be later reused, resold and recycled. Specialist guidelines exist on the sourcing, treatment, transport, storage and use of timber in humanitarian response.

📖 UN/OCHA, 2009. *Timber-a guide*.

**Environmental concerns**

178. Environmental concerns should be central to decisions over how timber and bamboo products are used, for example avoiding deforestation and creating landslide hazards and soil degradation. 📖 UN/OCHA, 2009. *Timber-a guide*

**Sawn timber**

179. Sawn timber can be used for frames, roof trusses and, in lapped planks, as a walling. Timber is sawn in saw mills or locally with hand saws or chainsaws into standard sizes and lengths. The timber should ideally be pressure treated with preservatives and dried to control moisture content, reducing cracks or shakes, as well as reducing twisting after it has been used, which reduces its structural value. Un-dried “green timber” can also be used, if it is detailed and fixed appropriately. Adapted from 📖 MSF Spain, 2011. *Small Constructions Manual*, p.41.



5.11 Timber frame construction, Leogane/Haiti 📷 Cordaid Haiti.

180. Diagram 5.16 shows common connections for timber.

**Diagram 5.16  
Cut timber connection types**

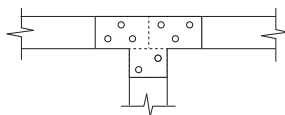

Horizontal timber connection with a nailed fish plate can be made at joint with upright timber member for greater strength.

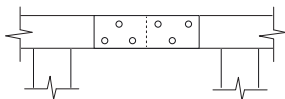

Horizontal timber connection made mid-span, which weakens the joint.

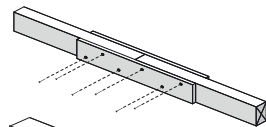
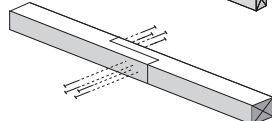

Plate and nails add strength to timber connection.



Lap joint fixed either side with adequate lap length.

1

definition

- definition of TS
- 10 TS principles
- 5 characteristics
- when not to use TS
- SWOT

2

tool

- decision-making tool

3

programme

- coordination
- programme plan
- assessment
- beneficiaries
- labour
- materials
- procurement
- support
- quality assurance

4

site

- community
- site selection
- site planning
- land tenure
- handover

5

design

- socio-cultural
- minimise risk
- climatic design
- materials
- construction

resources

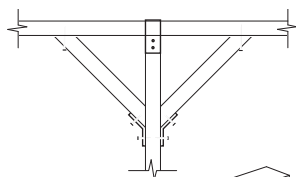

Bracing to increase rigidity, steel strapping fixed with galvanised flat nails to prevent uplift.

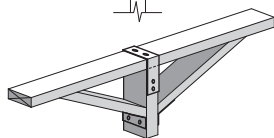

Timber roof joint reinforced with a gusset plate made from, for example, steel or wood.

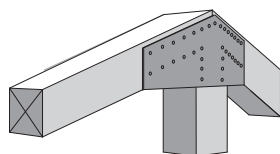

### Poles

181. Poles can be used for frames and roof structures. Poles can be harvested as young trees or from the trimming of larger trees. It is not necessary to reduce the bark, which can provide a useful protection. Poles can be cheaper than sawn wood and can, if used correctly, be stronger. Adapted from  MSF Spain, 2011. *Small Constructions Manual*, p.41.

### Timber composites

182. Timber and bamboo products are often used in panels for walls. They are manufactured in a different ways, composed of layers of fine timber that are glued together to form boards. Plywood, medium density fibre board (MDF) and oriented strand board (OSB), are some examples of this kind of timber product. Locally-made mats may also be made from bamboo, or timber frames in-filled with woven grasses, reeds or leaves. The main advantages of using these products are that they are lightweight, strong and low cost. Adapted from  MSF Spain 2011. *Small Constructions Manual*, p.41.



5.12 Traditional “clissade” technique of intertwined slats, Haiti  
 David Sacca/Handicap International.

**The different uses of bamboo**

183. Bamboo can be used for frames and roof structures, as well as when split for roof covering and walls. Bamboo is a useful construction material due in part to its fast rate of growth. It can grow up to 30m long, depending on its type. Of the 1,200 existing botanical species of bamboo, over 250 varieties are suitable for construction. Bamboo poles are flexible and strong, being hollow tubes. Curing and treatment add to durability.

📖 Humanitarian Bamboo, *Homepage* [online].



5.13 **Bamboo roof structure, Pakistan** 📖 *Usman Ghani/IOM Pakistan.*

184. When building with bamboo, special techniques for connections are necessary, in order to prevent the material from splitting or being crushed. If bamboo is not one of the local construction techniques understood by the community, training and additional quality assurance will be required. Adapted from 📖 MSF Spain, 2011. *Small Constructions Manual*, p.42.

185. Diagram 5.17 shows good and bad practice in relation to nodes when connecting bamboo. Connection type is shown indicatively.

**Diagram 5.17**  
**Bamboo connection considerations**

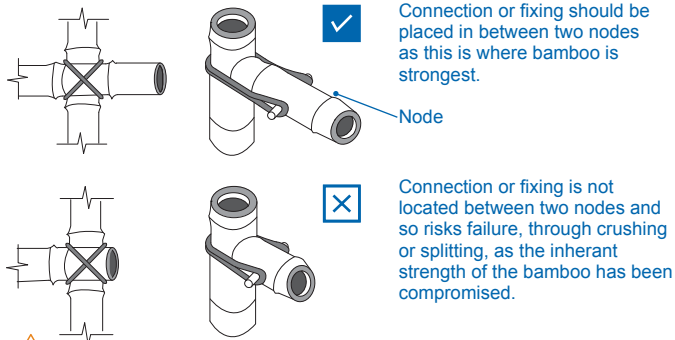

⚠️ **Attention: Do not nail bamboo**

Bamboo should always be drilled to avoid splitting.

1

definition of TS  
10 TS principles  
5 characteristics  
when not to use TS  
SWOT

definition

2

decision-making tool

tool

3

coordination  
programme plan  
assessment  
beneficiaries  
labour  
materials  
procurement  
support  
quality assurance

programme

4

community  
site selection  
site planning  
land tenure  
handover

site

5

socio-cultural  
minimise risk  
climatic design  
materials  
construction

design

resources

## Concrete

186. Concrete is mainly used for foundations in transitional shelter and is often unreinforced. Concrete blocks are also commonly used for walling and are sometimes fixed with a light mortar to enable their reuse, resale or recycling.

187. Concrete results from the mixture of cement, sand, gravel and water. The gravel and sand aggregates are held together by cement, which is cured through a chemical reaction with water, achieving 80% strength within 30 days when cured correctly.

188. Table 5.1 shows commonly used concrete mix ratios by volume.

**Table 5.1**  
**Concrete mix ratios**

Table 5.1 Concrete mix ratios				
	Cement	Sand	Fine sand	Aggregate
Floor	1	2	0	4
Beams, columns	1	2	0	3
Waterproofing	4	5	1	10

Adapted from  van Lengen, J., 2008. *The Barefoot Architect: A Handbook for Green Building*.

**Reinforced concrete**

189. Concrete has an excellent capacity to withstand compressive forces, however, it has no tensile strength. This makes it particularly appropriate for use in columns but potentially problematic when used in beams or slabs due to the tension that occurs on the underside of these members. This may lead to severe complications, which could cause the concrete to crack or even break. To give concrete some tensile strength it is necessary to reinforce the concrete by using steel bars or meshes for example. The concrete is poured around the steel reinforcement and after curing, the concrete and reinforcement form a composite material with both compressive and tensile strength.

**Prefabricated concrete building elements**

190. The main use of prefabricated concrete in transitional shelter is in columns as part of a frame structure, used in areas where timber is difficult to source sustainably. Concrete building elements can also be prefabricated, rather than being cast in situ. These are faster to use and may be cheaper, however, considerable care must be taken with jointing. Prefabricated concrete is rarely appropriate in seismic areas. Adapted from  MSF Spain, 2011. *Small Constructions Manual*, p.39.



### **Attention: Steel and salt**

Beware of the need to protect steel elements in reinforced concrete against the effects of water salinity, especially in coastal areas.



## Earth structures

### Suitability

191. Earth is used in many traditional construction techniques worldwide to build walls. The earth may be used as air dried bricks, stabilised soil blocks (SSBs), in lumps (cob), rammed into a formwork (pise), or applied to a panel of woven timber (lath and plaster). Earth walls can be used for upgrading a transitional shelter. They are simple to construct, incombustible, thermally massive and use readily available, inexpensive materials. They are, however, very time consuming to construct. Stabilisers, such as cement or lime, can be added to make the earth more durable, and should be carefully covered during curing. Finished walls should be protected by large overhangs, to prevent erosion damage from rainwater.



5.14 Handmade air dried bricks, Pakistan 📷 Usman Ghani/IOM Pakistan.

### Mortars

### Suitability

192. Mortars are used for bonding bricks and blocks. Mortars are a mixture of sand, lime or cement and water, in different proportions depending upon the use. Cement works as the binding material. Sand gives strength to the mixture, and prevents cracks that might occur if only the binding agent is used. Water is added to hydrate the cement or lime, creating the chemical reaction that results in the curing of the mortar. Water also gives the mixture sufficient plasticity to be worked with by the mason laying the bricks and blocks. This process can be done manually or mechanically with a concrete mixer. Adapted from 📖 MSF Spain, 2011. *Small Constructions Manual*, p.34.

1

definition of TS  
10 TS principles  
5 characteristics  
when not to use TS  
SWOT

definition

2

decision-making tool

tool

3

coordination  
programme plan  
assessment  
beneficiaries  
labour  
materials  
procurement  
support  
quality assurance

programme

4

community  
site selection  
site planning  
land tenure  
handover

site

5

socio-cultural  
minimise risk  
climatic design  
materials  
construction

design

resources

193. Table 5.2 shows common mortar mix ratios by volume.

**Table 5.2**  
**Mortar mix**  
**ratios**

Table 5.2 Mortar mix ratios					
	Lime	Cement	Sand	Fine sand	
Mortar between bricks and blocks	2	1	6		0
Inside walls	4	1	0		16
Outside walls	4	1	0		12
Waterproofing	0	1	0		2

Adapted from  van Lengen, J., 2008. *The Barefoot Architect: A Handbook for Green Building*.

### Thatching

#### Suitability

194. Thatching of grasses, reeds or leaves is commonly used to waterproof transitional shelter roofs. The same materials may be used as lightweight and inexpensive walling, flooring and doors when woven into screens. Local knowledge is important for harvesting, procurement, design and use in construction. When used on its own as a roofing material, thatch is commonly laid in thick bundles. Care should be taken to ensure that the roof is pitched enough to prevent rainwater from soaking into the thatch. Thatch roofs can increase the weight load on the structure, which should be considered when designing the walls and foundations.



5.15 Woven roof mats, Pakistan  IOM Pakistan.

195. This section provided basic information on common materials that may be suitable for use in transitional shelter construction, also stating the importance of local traditional building techniques, when implementing a transitional shelter programme.

## 5.5

# CONSTRUCTION PRINCIPLES

### Intention of this overview of construction

196. This section provides an overview of common construction techniques suitable for transitional shelter programmes. It does not offer comprehensive guidance on construction, however, references are made to appropriate publications.

197. The intention of offering this overview is to support the collaboration of the stakeholders in transitional shelter projects, including the priorities and capacities of the affected population and government. If humanitarian agencies are involved, stakeholders will include also country-level managers and fundraisers. These roles require a more technical understanding of the transitional shelter programme, in order to support the reconstruction. Programme extension staff, including assessment teams, along with procurement officers and logisticians will need to understand approaches to construction if they are to inform and resource the programme. Finally, programme and project staff, including their technical advisors, will need to coordinate with these other stakeholders, communicating construction advice clearly and supporting each other to fully fulfil their roles.

### Involving the affected community

198. Construction methods and techniques should be selected in consultation with the affected population. The affected population will begin to recover and to construct shelters immediately following the disaster. These efforts should be supported through the choice of construction methods and materials.

 **Attention: Using a professional**

This overview cannot be used as a substitute for the advice of trained professionals. Designs should be made involving the community but must be approved by either a local or external professional qualified in architecture, structural, or civil engineering.

### Section structure

199. The guidance is structured into sub-sections on foundations, floors, walls, openings, roofs and maintenance.

### Learning from local construction principles

200. Local construction techniques and typologies will provide further insights into the principles locally developed for constructing safe and appropriate shelter. The stakeholders involved in construction will also have many valuable insights and should be involved. They will be able to explain why local traditions, or principles, exist and how they might be relevant to transitional shelter.

1

definition of TS  
10 TS principles

5 characteristics

when not to use TS

SWOT

2

decision-making tool

3

coordination

programme plan

assessment

beneficiaries

labour

materials

procurement

support

quality assurance

4

community

site selection

site planning

land tenure

handover

5

socio-cultural

minimise risk

climatic design

materials

construction

definition

tool

programme

site

design

resources



## Case study: Sri Lanka post-tsunami, 2005—Local tradition in construction

Following the Indian Ocean tsunami in 2004, transitional shelters were constructed rapidly around the 800 km of affected coastal area of Sri Lanka. The transitional shelters varied significantly in the materials used and how they were constructed, responding to variations in local traditions. This clearly demonstrated that humanitarian agencies involved the affected community in shelter design and thereby improved cultural appropriateness and local incremental upgrading.

UN, 2010. *SAD*, p.91.

### Building on local construction techniques

201. Building transitional shelters should involve only minimal changes to local traditional construction techniques, with any changes made only to ensure safety and ensure the shelter is transitional, in order to maximise both the quality of the construction and sustainable positive impacts upon parallel reconstruction. »5.4

## 5.5.1 FOUNDATIONS

### Function

202. The function of building foundations is to transfer the load of the building to the ground. They also prevent a building from overturning, sliding or being lifted up by high winds. Improper foundations may compromise the safety and utility of the structure, as illustrated in Diagram 5.18.

### Diagram 5.18 Types of damage due to inadequate foundations



#### Excessive settlement

May occur if the ground on site is soft



#### Differential settlement

Unequal settling caused by poor ground conditions under the building and/or poor foundation construction



#### Frost heave

Seasonal freeze-thaw cycles may cause the foundation to shift if it is not buried below the frost line and adequately insulated



#### Hazard

Foundations should take into consideration the likelihood of future natural hazards and attempt to mitigate their effects through design



#### Wind uplift

May occur if the shelter is not adequately anchored to the foundation

## Key properties

203. In most situations, the foundations of transitional shelters should:

- ▶ be quick to construct;
- ▶ use minimal and inexpensive materials; and
- ▶ be removable, especially in cases where land rights preclude permanent construction.

Consideration should also be given to the possibility of making foundations sufficient for permanent construction. However, there may be time and cost implications in this approach.

204. “A foundation works as a footprint of the building. It supports it and functions as a tie between the construction and the ground. Depending on the type of ground on the construction site, there are different types of foundation techniques and issues to consider within its construction process.”  MSF Spain, 2011. *Small Constructions Manual*, p.53.

## Factors to be considered

205. The loads of a building are carried by the foundation. It distributes the loads over the ground. Different types of foundation are used, depending on the following factors:

- ▶ building load—it is advisable to calculate the load of the building in order to use the appropriate type of foundation according to the calculated needs. For example, the number of floors of the building and specific materials have a direct influence on the type and dimensions of the foundation;
- ▶ structural form of building—certain structural elements of a building might influence the use and appropriateness of certain foundations. For example, if overhanging structural elements are integrated or load bearing walls are in place, this may influence the type and dimension of the foundation. Special care should be taken in these situations;
- ▶ ground condition and types—the appropriateness of a specific type of foundation is directly related to the type of existing ground on the construction site; and
- ▶ climate and geophysical factors (such as cyclones, earthquakes, etc.)—the appropriateness of a foundation design is directly related to the climate and/or potential risks and hazards.

206. Foundations should be built on solid ground. Adapted from  University of Cambridge, 2005. *TSDP*, p.280.

## Types of foundations

207. Four set foundations used in building construction are:

- ▶ anchor foundations;
- ▶ pad foundations;
- ▶ strip foundations; and
- ▶ slab foundations.

1

definition of TS  
10 TS principles  
5 characteristics  
when not to use TS  
SWOT

definition

2

decision-making tool

tool

3

coordination  
programme plan  
assessment  
beneficiaries  
labour  
materials  
procurement  
support  
quality assurance

programme

4

community  
site selection  
site planning  
land tenure  
handover

site

5

socio-cultural  
minimise risk  
climatic design  
materials  
construction

design

resources

**Types of foundations**

**Diagram 5.19  
Main types of foundation diagrams**

208. The typical layouts of four set foundations can be seen in Diagram 5.19. Further details about when to use them, and their suitability, are provided in this chapter.

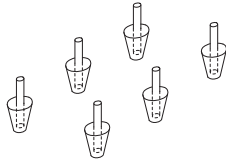

Anchor foundation

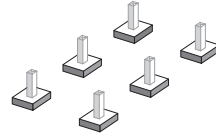

Pad foundation

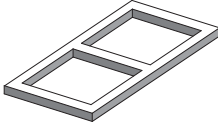

Strip foundation

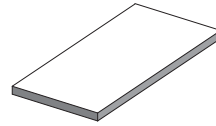

Slab foundation

**Anchor foundations**

**When to use anchor foundations**

209. Anchor foundations are primarily of use to “anchor” light structures to the ground to prevent them from being blown away in high winds. Backfill for anchor foundations can make use of any available heavy substance such as, compacted soil, debris or concrete.

**Suitability**

210. Anchor foundations are simple to construct but should be used only for very light structures such as those made of a lightweight frame and plastic sheeting. This type of foundation offers very little additional support to spread the load of the structure in the ground so it should only be used in firm grounds containing little organic material. Various anchor foundation types are shown in Diagram 5.20

**Diagram 5.20  
Anchor foundations**

**Anchored ground beam foundation**

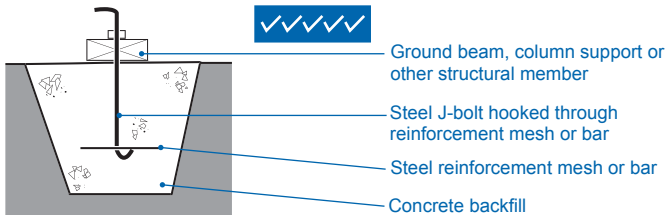

**Metal base plate anchored by J-bolts**

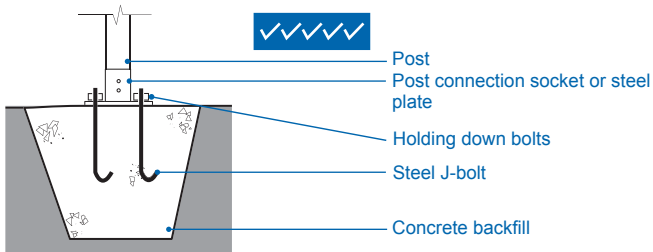

### Wooden anchor foundation

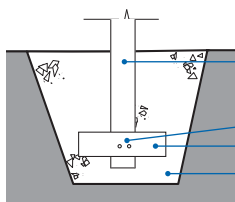

- Wooden post or other structural member
- Secure connection
- Wooden anchor or cross beam
- Concrete backfill

### Post anchored by protruding nails

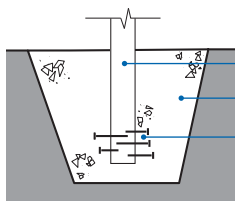

- Wooden post
- Concrete backfill
- Large protruding nails or drilled-in reinforcement bars

### Debris anchor foundation

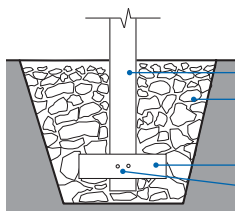

- Wooden post
- Backfill of wedged rocks, debris or compressed earth firmly compacted in layers
- Wooden anchor or cross beam
- Secure connection

## Pad foundations

### When to use pad foundations

211. When it is necessary to support high loads over a limited area pad foundations should be used. A hole is dug in the ground directly under the place where the column is located. This hole is filled with concrete, and the column itself is then attached securely to the concrete. To attach the column to the concrete base the following methods can be used:

- ▶ hold-down bolts and column base plates for timber and steel columns; and
- ▶ L-shaped reinforcement bars inside poured-concrete columns and linked with horizontal bars in pads. Adapted from University of Cambridge, 2005. *TSDP*, p.282.

### Suitability

212. Pad foundations can be valuable in transitional shelter because they require the minimum intervention when land rights are not secured. Small pads can also be precast and even moved along with the shelter. This type may be suitable when building with lightweight structures of steel, masonry or timber, and when columns are used. However, care must be taken in areas at risk of high wind. Adapted from University of Cambridge, 2005. *TSDP*, p.282.

1

definition of TS  
10 TS principles  
5 characteristics  
when not to use TS  
SWOT

definition

2

decision-making tool

tool

3

coordination  
programme plan  
assessment  
beneficiaries  
labour  
materials  
procurement  
support  
quality assurance

programme

4

community  
site selection  
site planning  
land tenure  
handover

site

5

socio-cultural  
minimise risk  
climatic design  
materials  
construction

design

resources



**Diagram 5.21**  
**Pad foundation**

213. Diagram 5.21 shows a typical pad foundation arrangement.

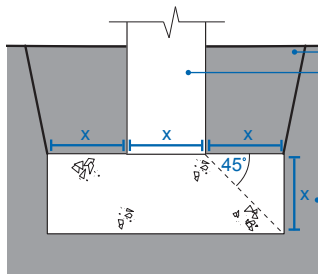

Foundation width to be designed by a specialist.  
Well compacted backfill.  
Foundation wall/ timber or concrete post centred on the foundation with equal projection of footing either side.  
*\*Note: consider design life if timber is used below ground*  
Minimum thickness of foundation should be equal to foundation projection or 150mm, whichever is greater.

### Strip foundations

**When to use strip foundations**

214. The bed of a strip foundation should include materials such as concrete or compacted stones, depending on the ground conditions. On top of this bed, long continuous footings are laid that stretch underneath the whole length of load bearing walls. When concrete is used a minimum foundation thickness of 150mm is needed. Steel bar reinforcement, determined by site factors and foundation depth, should be placed before pouring the concrete to increase the strength and rigidity in the foundation. Adapted from University of Cambridge, 2005. *TSDP*, p.281.



**Suitability**

215. Strip foundations should be used when building with lightweight masonry and other structures. Trench fill foundation is a variation of a strip footing. These are deeper than the strip foundations, and enable the support of loads through frictional resistance at the side from the surrounding ground. Concrete, with or without reinforcement, is poured into the trench. Adapted from University of Cambridge, 2005. *TSDP*, p.281.

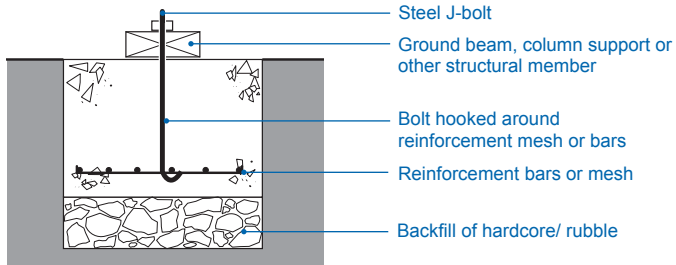

216. Diagram 5.22 shows a ground beam strip foundation construction.

**Diagram 5.22**  
**Ground beam foundation**



<b>When to use slab foundations</b>	<p><b>217.</b> This type of foundation consists of a concrete slab with steel reinforcement or, often steel mesh, to provide extra strength particularly at the edge of the building perimeter. Often in these locations the slab is thickened to provide extra load bearing capacity. Adapted from  University of Cambridge, 2005. <i>TSDP</i>, p.283.</p>	<p><b>1</b> definition of TS 10 TS principles 5 characteristics when not to use TS SWOT</p>
<b>Suitability</b>	<p><b>218.</b> Slab foundations should be considered in weak ground. This helps to spread the building loads over a wider area, avoiding structural complications related to building settlement. Due to a more complex construction process, all foundations should be designed and calculated by a qualified engineer. Advanced building skills and additional materials may be needed. The use of slabs in transitional shelter must only be considered if essential because if the building is moved the slab will need to be broken up and cannot be reused efficiently. Adapted from  University of Cambridge, 2005. <i>TSDP</i>, p.283.</p>	<p><b>2</b> decision-making tool</p> <p><b>3</b> coordination programme plan assessment beneficiaries labour materials procurement support quality assurance</p>

## 5.5.2 FLOORS

<b>Floor types and materials</b>	<p><b>219.</b> Floors can be divided into two types, solid or suspended. In the case of the solid type, the ground itself helps to support floor. Suspended floors span between supporting beams. Materials used for floors include the following:</p> <ul style="list-style-type: none"> <li>▶ earth, such as lime, cement, or cow dung;</li> <li>▶ concrete;</li> <li>▶ timber beams or joists covered with decking or sheet materials; and</li> <li>▶ concrete beams and infill blocks with a floor screed.</li> </ul> <p>Adapted from  University of Cambridge, 2005. <i>TSDP</i>, p.284.</p>	<p><b>4</b> community site selection site planning land tenure handover</p>
<b>Site preparedness</b>	<p><b>220.</b> Careful preparation of a site, particularly the removal of all organic materials, is necessary when building an earth floor.</p>	
<b>Moisture considerations</b>	<p><b>221.</b> Waterproofing is necessary in order to avoid moisture infiltration through the floor to the living space. There are different ways of creating this barrier. The fastest and easiest way is to use plastic sheeting, such as polythene, resting over a layer of dry sand for protection.</p>	<p><b>5</b> socio-cultural minimise risk climatic design materials construction</p>
<b>Drainage</b>	<p><b>222.</b> It is very important to create drainage around the entire perimeter of the building, and it is advisable that the finished floor level is raised at least 150mm above the surrounding ground level. This will reduce splash damage. An overhanging roof should also be placed to help to keep the floor dry.</p>	
<b>Stabilising agents</b>	<p><b>223.</b> Durability of earth floors can be improved by adding stabilising agents, such as clay, or lime, to the upper layers of the ground. Adapted from  University of Cambridge, 2005. <i>TSDP</i>, p.284</p>	<p>resources</p>

## Suspended floors

224. Suspended floors should be used for raised or stilt houses, or for irregular ground conditions. They consist of timber joists, which are covered with wooden boards or plywood. The joists are supported by blocks or beams placed under them. Rodents or other small animals could inhabit the space underneath suspended floors and so gaps should be sealed off. Steel mosquito nets are usually an appropriate solution as they allow air circulation, which is imperative to prevent wood rot. Adapted from  University of Cambridge, 2005. *TSDP*, p.285.

225. Diagram 5.23 shows a suspended timber floor, which can be used on flat or uneven ground.

**Diagram 5.23**  
Suspended  
timber floor on  
a brick plinth

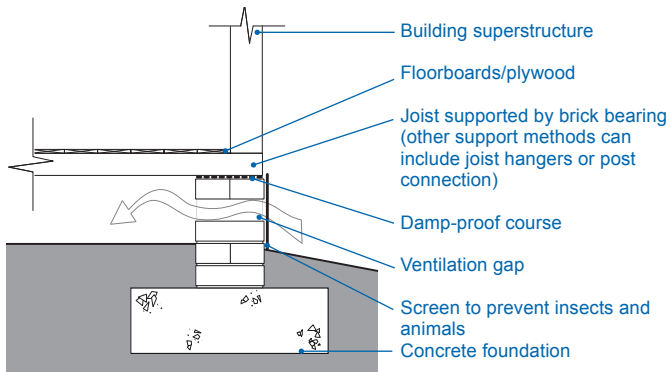

## Concrete floors

**How to  
construct  
concrete floors**

226. Concrete floors are very durable, however, their use in transitional shelter should be carefully considered if shelters are likely to be relocated. Concrete paving slabs can be used instead, loose laid on a compacted blinding of sand, to create a flat surface. The common construction procedure consists of pouring the concrete over a 150mm thick bed of gravel. To avoid moisture infiltrating the slab, a damp-proof membrane, such as polythene sheeting, should be placed underneath the concrete slab. The damp-proof membrane should be protected from the gravel bed with a layer of sand.

227. To increase the durability of the floor a mesh is placed before pouring the concrete. Large or irregular slabs should be cast in sections, with an expansion joint between them to minimise possible complications regarding settlement and expansion cracks. Adapted from  University of Cambridge, 2005. *TSDP*, p.284.

228. Diagram 5.24 shows an example of a solid ground bearing concrete floor construction.

Diagram 5.24  
Solid floors

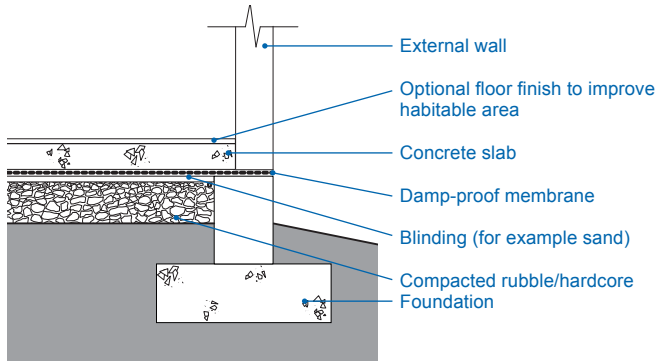

### 5.5.3 WALLS

#### Structural purpose of walls

229. Walls provide protection from the elements, security and privacy for the building's occupants. Walls may also serve to transfer building loads to the foundation, which are then transferred safely to the ground.

230. Transitional shelters can use frame structures of many different materials including timber, bamboo, or steel. By doing so they can be incrementally added to, starting with simple walls of mats woven from grasses, reeds or bamboo, or of plastic sheeting, some of which may have been distributed earlier in the response.

#### Non load-bearing walls

231. Internal walls do not suffer the same degree of stresses as exterior and load-bearing walls, although interior dividing walls may also provide support to load-bearing walls, in the form of lateral support, and support to ceiling joists.

232. Care should be taken in understanding that frame structures and non load-bearing walls may move differently under stresses. Hazards such as high winds, floods or earthquake, can easily collapse these walls, potentially causing injury. All non load-bearing walls should be tied to the frame using ties of adequate strength at regular intervals.

#### Key considerations

233. When using non load-bearing walls with a frame structure, unless special measures are taken and it is essential to the local design, they should ideally not be placed between the columns of the frame, but instead inside or outside the frame, tied back to the frame at regular intervals with straps or heavy gauge wire. This is because infill walls are very unstable, even if fixed between frames. Confined masonry is an alternative type of construction and can reduce problems associated with the stability of framed masonry infill walls.

1

definition of TS  
10 TS principles  
5 characteristics  
when not to use TS  
SWOT

definition

2

decision-making tool

tool

3

coordination  
programme plan  
assessment  
beneficiaries  
labour  
materials  
procurement  
support  
quality assurance

programme

4

community  
site selection  
site planning  
land tenure  
handover

site

5

socio-cultural  
minimise risk  
climatic design  
materials  
construction

design

resources

234. Special care must be taken also when placing interior masonry walls. These produce high loads that have to be supported by the foundation. Adapted from  University of Cambridge, 2005. *TSDP*, p.288.

**Load-bearing walls**

235. Building loads produce two main types of stress on walls:

- ▶ compressive stress, produced when walls are being compressed by dead and live loads acting upon them; and
- ▶ tensile stress, when the wall is being stretched by loads acting upon them.

236. To resist these loads, structural wall components must be stiff, dense and stable.  University of Cambridge, 2005. *TSDP*, p.286.

**Timber, bamboo or steel frames**

237. The use of timber, bamboo or steel frames is common in transitional shelter designs. These materials tend to be cheaper, easier to transport, faster to build with, and more suited for relocation than masonry walls.

Corners and columns in timber framed walls should be built using longer pieces, which helps the transferring of loads over a wider area. Intermediate posts should be placed, although these may be smaller. Adapted from  University of Cambridge, 2005. *TSDP*, p.286.

238. Diagram 5.25 shows where loads should be focused on a framed wall.

**Diagram 5.25**  
**Framed wall**

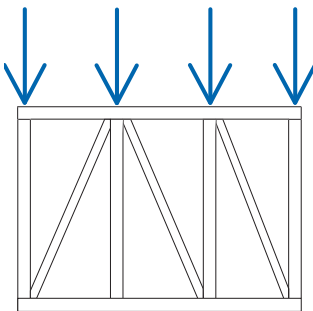

Load from roof truss or other load bearing member focused at column/posts.

Loads transferred through the column.

Bracing provides lateral stability (consider bracing in both directions).

**Masonry and earth walls**

239. Masonry and earth walls must cope with the stresses created by the building dead loads and imposed live loads, from people, furniture, equipment and other added loads once the building is finished.

240. Earth walls may be made from soil stabilised blocks, air-dried mud bricks, cob or lumps of mud, or rammed earth. Each type of earth wall has its own technique and composition, for example where clay is mixed with straw or animal dung in order to improve its strength and elasticity. Local traditions in earth construction should be studied, along with local ground types.



5.16 Sandbag wall construction, Pakistan  IOM Pakistan.

#### Distribution of loads

**241.** The distribution of loads in a masonry wall is usually made through the bond between bricks or blocks. Alternating each course creates strength and transfers loads throughout the wall.

**242.** To improve lateral stability of long lengths of wall between corners or support columns, especially when building masonry walls, it is advisable to place piers and/or buttresses. Adapted from  University of Cambridge, 2005. *TSDP*, p.286.

#### Structural reinforcements: connections

**243.** Load-bearing walls should have solid connections to roof structures, foundations and adjoining walls, so that these different structural elements can function as one structure. In the case of timber framed walls, nails, bolts, wire and rope can be used as connector elements. In the case of steel columns and beams, bolts and/or welded connections are advisable. With concrete columns these should be integrated with horizontal supports in beams and foundations. This is done through wire ties that connect the steel bars in the columns and beams, and then by the casting the concrete in place. Special care is needed where high winds, heavy rainfall and seismic activity occur, and additional connectors should be used. Adapted from  University of Cambridge, 2005. *TSDP*, p.287. Reinforcement connections should always be designed by a qualified specialist.

#### Structural reinforcements: horizontal ties

**244.** Horizontal ties are often needed as horizontal reinforcement. Horizontal rings can be placed at foundation level as well at the eaves level. These help to reduce the effects of loads, and should be placed along the entire perimeter of the building. Adapted from  University of Cambridge, 2005. *TSDP*, p.287.

#### Structural reinforcements: bracing

**245.** In order to improve a walls resistance to lateral forces, such as wind, diagonal bracing is often placed in walls. Diagonal bracing provides the structural rigidity to the frame. Adapted from  University of Cambridge, 2005. *TSDP*, p.287.

1

definition of TS  
10 TS principles  
5 characteristics  
when not to use TS  
SWOT

definition

2

decision-making tool

tool

3

coordination  
programme plan  
assessment  
beneficiaries  
labour  
materials  
procurement  
support  
quality assurance

programme

4

community  
site selection  
site planning  
land tenure  
handover

site

5

socio-cultural  
minimise risk  
climatic design  
materials  
construction

design

resources

**Diagram 5.26**  
Function of  
bracing in  
framed walls

246. Diagram 5.26 shows the the function of bracing.

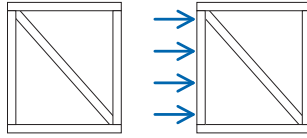

✓ Diagonal bracing resists lateral forces, such as wind. This making the structure less prone to damage. Bracing should be considered in more than one direction.

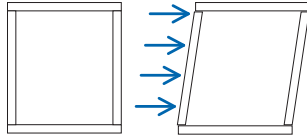

✗ Lack of bracing results in an inherently weak structure, prone to distortion or collapse.

**Openings:  
windows and  
doors**

247. Window and door openings can weaken the structural integrity of walls, unless care is taken to ensure that the load above the openings is adequately transferred to other structural components. Lintels are horizontal beams set above wall openings to support the wall above. They are often supported by columns/posts on the immediate sides of the openings, which transfer the loads to the foundation. Materials used for lintels include wood, concrete, stone, or brick. It is advisable to place wall openings 600mm or more from the building corners. This is done in order to preserve the transferring of loads through walls. Adapted from University of Cambridge, 2005. *TSDP*, p.287. These principals are shown in Diagram 5.27 below.

**Diagram 5.27**  
Rules of  
thumb for  
placement and  
dimensions of  
openings

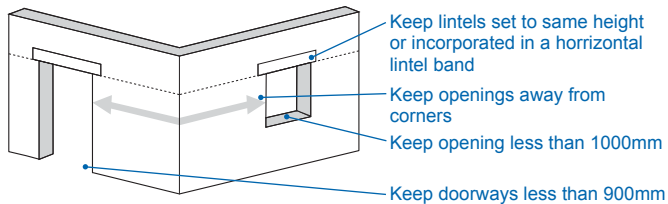

## 5.5.4 ROOFS

248. Roofs work as a protection against the weather, including rain and snow, helping also to control heat loss and condensation. Roofs consist of a structure, such as rafters or trusses, and a covering, such as plastic sheeting or thatch. The choice of which type of roof to build should consider issues related to climate, culture and design. Adapted from University of Cambridge, 2005. *TSDP*, p.289.

**Pitched roofs**

249. Pitched roofs are mainly found in temperate and tropical climates, due to their ability to drain water. The pitch of the roof depends on the covering material used, the rainfall, and the likeliness of high winds and storms. Plastic sheeting roofs



may be pitched as low as 20 degrees, however, if they are to be upgraded incrementally using other materials, the pitch should already be designed for the other materials. Tile roofs may be pitched between 30 degrees and 60 degrees. Thatch roofs of grass, straw, leaves or reeds should follow the local tradition but should certainly exceed 35 degrees. Corrugated galvanised steel roofs may be used from 15 degrees, if the overlap is sufficient and there are no high winds, to over 45 degrees. Roofs made from masonry are usually in arches or parabola, to transfer the heavy load to the ground without requiring extensive buttressing.

250. Diagram 5.28 shows the typical construction of a single pitched timber roof.

Diagram 5.28  
Single pitched roof construction

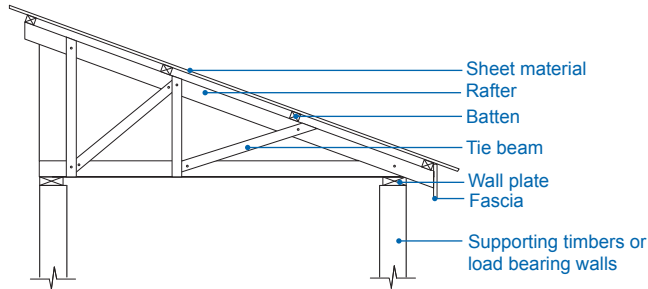

251. Diagram 5.29 shows the construction of a typical trussed rafter roof.

Diagram 5.29  
Trussed rafter roof construction

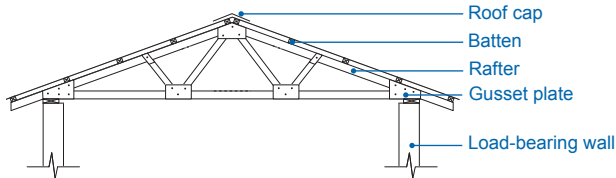

5.17 Double-pitched roof construction, Haiti  Cordaid Haiti.

1

definition of TS  
10 TS principles  
5 characteristics  
when not to use TS  
SWOT

definition

2

decision-making tool

tool

3

coordination  
programme plan  
assessment  
beneficiaries  
labour  
materials  
procurement  
support  
quality assurance

programme

4

community  
site selection  
site planning  
land tenure  
handover





site

5

socio-cultural  
minimise risk  
climatic design  
materials  
construction

design

resources

- Pitched roofs types** 252. There are different main types of pitched roof:
- ▶ gable roof (two slopes); and
  - ▶ hip roof.
- Gable roofs** 253. In a gable roof, rafters extend at a certain angle between 30 degrees and 45 degrees from the walls to the centre where they meet a ridge board. The lower ends of the rafters usually extend 300 to 400mm from the walls as eaves, in order to protect walls and foundations from rain and direct sun exposure. Adapted from  University of Cambridge, 2005. *TSDP*, p.290.
- Hip roofs** 254. Hip roofs, with their four slopes, offer better protection against winds. These roofs expose a smaller surface to the wind, so the effects of wind loads and uplift are limited. Adapted from  University of Cambridge, 2005. *TSDP*, p.290.
- Flat roofs** 255. Flat roofs are rarely used in transitional shelters but when they are it is mainly in hot and dry regions. They are less suitable for tropical climates, or cyclone/hurricane prone areas. They represent the simplest roof structure. It is advisable to include a minimum gradient of 30mm per metre which allows water to drain.
- Commonly used roofing materials** 256. Common materials used in flat roofs include a structure of timber or steel; a bearing layer of timber, bamboo or matting steel; and a covering layer of mud. Alternatively, if rainfall is extremely rare, a lightweight roof of timber, bamboo, matting, thatch or plastic sheeting may be considered. Different coverings can be used from organic to cement based products, earth, tiles or metal coverings. Adapted from  University of Cambridge, 2005. *TSDP*, p.289.
- Roof overhangs** 257. Extended roof overhangs can protect walls and foundations from direct exposure to heavy rains. However care should be taken in areas of strong wind, as large overhangs are susceptible to uplift.
- Roof drainage** 258. Drainage has to be included in the construction of a roof. Drainage channels (gutters) are attached to the eave edges of roofs in order to collect rainwater, and to carry it to downspouts and away from foundations. This water may be collected in storage tanks or butts and used for household needs. Adapted from  University of Cambridge, 2005. *TSDP*, p.290.

## 5.5.5 MAINTENANCE

259. After a building is finished regular maintenance has to be done, in order to prevent the degradation of the shelter, prolonging its life. This will also prevent costly and time consuming rehabilitation work.
- Design for maintenance** 260. The shelter design process should always take into consideration the need for maintenance and its procedures.

Building maintenance should be considered as a regular and normal activity and not something that is done as a last resource. The shelter design should consider the need for it, and should facilitate access to certain building components that need special care and maintenance attention.

**Specific maintenance**

261. Regarding specific maintenance work, special attention needs to be paid to the roof. Gutters should be cleaned regularly, especially before the rainy season.

262. Building defects should be immediately addressed and treated, preventing further deterioration of the building.

**Appropriate construction techniques and materials**

263. If the choices regarding the type of building, construction techniques and materials, were appropriate, maintenance should not represent a time consuming activity, although it should be done regularly, following continuous monitoring of all the building elements.

264. For further information please consult 📖 van Lengen, J., 2008. *The Barefoot Architect*.

1

definition of TS  
10 TS principles  
5 characteristics  
when not to use TS  
SWOT

definition

2

decision-making tool

tool

3

coordination  
programme plan  
assessment  
beneficiaries  
labour  
materials  
procurement  
support  
quality assurance

programme

4

community  
site selection  
site planning  
land tenure  
handover

site

5

socio-cultural  
minimise risk  
climatic design  
materials  
construction

design

resources



# RESOURCES

## Glossary

---

Terms	Definition
<b>Accountability</b>	Quality or state of being accountable. An obligation or willingness to accept responsibility for one's actions.
<b>Apartment owner-occupier</b>	Transitional reconstruction option where the occupant owns their apartment, a self-contained housing unit that occupies only part of a building, formally or informally.
<b>Apartment tenant</b>	Transitional reconstruction option where the apartment is rented by the occupant, formally or informally.
<b>Assessment</b>	Survey of a real or potential disaster to estimate the actual or expected damages and to make recommendations for prevention, preparedness, response and reconstruction.
<b>Assistance methods</b>	Variety of material or service contributions that are combined and offered to beneficiaries in implementing a transitional shelter programme.
<b>“Build Back Better”</b>	Approach to reconstruction that aims to reduce vulnerability and improve living conditions, whilst promoting a more effective reconstruction process.
<b>Building code</b>	Set of ordinances or regulations and associated standards intended to control aspects of the design, construction, materials, alteration and occupancy of structures necessary to ensure human safety and welfare, including resistance to collapse, damage and fire.
<b>Capacity</b>	Combination of all physical, institutional, social and/or economic strengths, attributes, and resources available within a community, society or organisation that can be used to achieve agreed-upon goals. Also includes collective attributes such as leadership and management.
<b>Capacity building</b>	Process by which the capacities of people, organisations and society are strengthened to achieve social and economic goals, through improvement of knowledge, skills, systems and institutions.
<b>Civil society organisation</b>	National and local non-governmental and not-for-profit organisations that express the interests and values of their members and/or others based on ethical, cultural, political, scientific, religious or philanthropic considerations.
<b>Climate change</b>	Meteorological changes attributed directly or indirectly to human activity or to natural climate variability, that alter the composition of the global atmosphere.
<b>Collective centre</b>	Collective centres are usually transit facilities located in pre-existing structures, such as community centres, town halls, gymnasiums, hotels, warehouses, disused factories and unfinished buildings. They are often used when displacement occurs inside a city, or when there are significant flows of displaced people to a city or town.

<b>Community</b>	Group of households that identify themselves in some way as having a common interest, bond, values, resources or needs as well as physical space. A social group of any size whose members reside in a specific locality, share government and often have a common cultural and historical heritage.
<b>Community participation</b>	Process whereby the affected population can influence development by contributing to project design, influencing public choices and holding public institutions accountable for the goods and services they provide.
<b>Community-driven reconstruction</b>	Approach to reconstruction that entails varying degrees of organised community involvement in the project cycle, generally complemented by the assistance of the agency that provides construction materials, financial assistance and/or training.
<b>Complaint mechanism</b>	Mechanism that allows the affected population, including public employees, to offer feedback and report issues such as corruption in a confidential manner.
<b>Construction guidelines or standards</b>	Document prepared by a recognised standard-setting organisation that prescribes methods and materials for the safe use and consistent performance of specific technologies; sometimes developed by consensus of users.
<b>Contour planning</b>	Approach to the layout and development of settlement options that follows or reflects the topography of the site.
<b>Damage assessment</b>	Process utilised to determine the magnitude of damage caused by a disaster or emergency.
<b>Debris</b>	Waste items such as trees, sand, silt, gravel, building components and contents, wreckage, vehicles and/or personal property resulting from a disaster.
<b>Disaster</b>	Any natural or man-made event causing distress or loss, e.g. earthquake, drought, flood, fire, epidemic and/or armed conflict.
<b>Disaster contingency planning</b>	Process that results in an organised, planned and coordinated course of action to be followed in case of an accident or disaster that threatens society or the environment. Such plans clearly identify the institutional and organisational arrangements that come into play in the event of a disaster that disrupts the coping mechanisms of communities and societies.
<b>Disaster response</b>	Process to address the immediate conditions that threaten the lives, economy and welfare of a community.
<b>Disaster risk management</b>	Systematic process of using administrative decisions, organisation, operational skills and capacities to apply strategies, policies and coping capacities of the society and communities to lessen the impacts of natural hazards and related environmental and technological disasters. This comprises all forms of activities, including structural and non-structural measures to avoid or limit adverse effects of hazards.
<b>Disaster risk reduction</b>	Systematic approach to identifying, assessing and reducing the risks of disaster.
<b>Displaced populations</b>	Persons who, for different reasons or circumstances, have been compelled to leave their homes. They may or may not reside in their country of origin, but are not legally regarded as refugees.
<b>Durable solutions</b>	Point at which permanent settlement and shelter for both displaced and non-displaced populations have been rebuilt and established, sufficient for communities to support their own livelihoods.
<b>Early recovery</b>	Process which seeks to catalyse sustainable development opportunities by generating self-sustaining processes for post-crisis recovery. It encompasses livelihoods, shelter, governance, environment and social dimensions, including the reintegration of displaced populations and addresses underlying risks that contributed to the crisis.

1

definition of TS

10 TS principles

5 characteristics

when not to use TS

SWOT

2

decision-making tool

3

coordination

programme plan

assessment

beneficiaries

labour

materials

procurement

support

quality assurance

4

community

site selection

site planning

land tenure

handover

5

socio-cultural

minimise risk

climatic design

materials

construction

definition

tool

programme

site

design

resources

<b>Early warning system</b>	Set of capacities needed to provide timely and meaningful information to enable individuals, communities and organisations threatened by hazards to prepare and act appropriately in sufficient time to reduce loss of life, injury, livelihoods, damage to property and the environment.
<b>Exposure</b>	Experience of coming into contact with an environmental condition or social influence that has a harmful or beneficial effect.
<b>Geographic information system</b>	Computer system for the input, editing, storage, retrieval, analysis, synthesis and output of location-based information. GIS may refer to hardware and software and include data.
<b>Hazard</b>	Potentially damaging physical event, phenomenon or human activity that may cause the loss of life or injury, property damage, social and economic disruption or environmental degradation.
<b>Hazard mapping</b>	Process of establishing geographically where and to what extent particular hazards are likely to pose a threat to people, property or the environment.
<b>Host family</b>	Family that shelters displaced persons within their households or on their property.
<b>House owner-occupier</b>	Transitional reconstruction option where the occupier owns their house and land or is in part-ownership, such as when repaying a mortgage or loan. Ownership may be formal or informal.
<b>House tenant</b>	The transitional reconstruction option where the house and land are rented by the occupant formally or informally.
<b>Inflation</b>	Increase in the supply of currency or credit relative to the availability of goods and services, resulting in higher prices and a decrease in the purchasing power of money.
<b>Internally displaced persons</b>	Persons displaced from their habitual place of residence by disaster, fear of persecution or fear of physical harm, but remaining within the territorial limits of their country of origin.
<b>Land tenant</b>	Transitional reconstruction option where the house is owned, but the land is rented.
<b>Liquefaction</b>	Process by which water-saturated sediment temporarily loses strength and acts as a fluid, typically as a result of an earthquake.
<b>Livelihoods</b>	Ways in which people manage their lives in order to access the resources, such as food, water, clothing and shelter, they need individually and communally, .
<b>Logical framework approach</b>	Conceptual tool used to define project, programme or policy objectives, expected causal links in the results chain, including inputs, processes, outputs, outcomes and impact. It identifies potential risks as well as performance indicators at each stage in the chain.
<b>Market analysis</b>	Research undertaken to understand how a market functions, how a crisis has affected it, and the need for and most appropriate form of support. Research can include information on supply and demand of goods and services, price changes and income/salary data.
<b>Mitigation</b>	Measures undertaken to limit the adverse impact of natural or other hazards, environmental degradation or potential disaster losses.
<b>Natural hazards</b>	Natural processes or phenomena (geological, hydrometeorological or biological) occurring in the biosphere that may constitute a damaging event.
<b>Needs assessment</b>	Process for estimating the financial, technical and human resources needed to implement the agreed programmes of recovery, reconstruction and risk management.

<b>Non-governmental organisation</b>	Non-profit, voluntary, service-oriented, and/or development-oriented organisation, operated either for the benefit of its members or of other members, such as an agency.	1 definition
<b>Non-food item</b>	Basic goods and supplies required to enable families to meet personal hygiene needs, prepare and eat food, provide thermal comfort and build, maintain or repair shelters.	
<b>Occupancy with no legal status</b>	Transitional reconstruction option where the occupant occupies property without the explicit permission of the owner.	
<b>Participatory assessment</b>	Approach to assessment that combines participatory tools with conventional statistical approaches intended to measure the impact of humanitarian assistance and development projects on people's lives.	2 tool
<b>Passive design</b>	Design approach that utilises natural elements and existing conditions such as sunlight, prevailing winds and temperature to reduce a shelter's energy consumption by minimising or eliminating the need for mechanical systems.	
<b>Planned camps</b>	Camps managed by government or aid organisations including infrastructure to house displaced populations.	3 programme
<b>Post-disaster needs assessment</b>	Usually a rapid, multi-sectoral assessment that measures the impact of disasters on the society, economy and environment of the disaster-affected area.	
<b>Programme plans</b>	Series of plans, agreed by all stakeholders, that is consistent with the strategic plan, and that integrates project plans in order to describe programmes that respond to transitional settlement and reconstruction needs.	
<b>Qualitative data</b>	Information based on observation and discussion that can include perceptions and attitudes.	4 site
<b>Quantitative data</b>	Numerical information, such as number of intended recipients, payments disbursed and cash transferred or days worked broken down by gender, age and other variables.	
<b>Rapid assessment</b>	Assessment that provides immediate information on needs, possible intervention types and resource requirements. It may be conducted as a multi-sectoral assessment or in a single sector or location.	
<b>Reconstruction</b>	Rebuilding of entire communities, including livelihoods, such that they are able to support themselves and have reduced vulnerability to future natural hazards.	5 design
<b>Recovery</b>	Decisions and actions taken after a disaster so that survivors are able to re-build their lives and livelihoods in a manner that reduces further exposure to disaster risks.	
<b>Relief</b>	Provision of assistance or intervention during or immediately following a disaster to meet the life preserving and basic subsistence needs of those people affected.	
<b>Relocation</b>	Process whereby a community's housing, assets and public infrastructure are rebuilt in another location.	resources
<b>Resettlement</b>	Actions necessary for the permanent settlement of persons dislocated or otherwise affected by a disaster to an area different from their last place of habitation.	
<b>Resilience</b>	Ability of a system, community or society potentially exposed to hazards to resist, adapt to and recover from the stresses of a hazard, including the preservation and restoration of its essential basic structures and functions.	



<b>Response</b>	Provision of emergency services and public assistance during or immediately after a disaster to save lives, reduce health impacts, ensure public safety and meet the basic subsistence needs of the affected people.
<b>Risk</b>	Possibility of harmful consequences or expected losses (deaths, injuries, damage to livelihoods property, economic activity disrupted or environment damaged) resulting from interactions between natural or human-induced hazards and vulnerable conditions.
<b>Risk assessment</b>	Methodology to determine the nature and extent of risk by analysing potential hazards and evaluating existing conditions of vulnerability that together could pose a potential threat or harm to people, property, livelihoods and the environment on which they depend.
<b>Rural self-settlement</b>	Settlement formed by displaced populations on collectively owned rural land.
<b>Self-settled camps</b>	Camp formed by the displaced population independent from government or aid agencies.
<b>Shelter</b>	Habitable covered living space, providing a secure, healthy living environment with privacy and dignity for the groups, families and individuals residing within it.
<b>Stakeholders</b>	Agencies and individuals who have a direct or indirect interest in a humanitarian intervention or development project, or who can affect or are affected by the implementation and outcome of it.
<b>Subsidence</b>	Lowering of the ground's surface in a particular area due to the removal of sub-surface support.
<b>Sustainable development</b>	Development that meets the needs of the present without compromising the ability of future generations to meet their own needs.
<b>Transitional shelter</b>	<p>A process, not a product, that shelters families after a conflict or disaster over the period of securing land tenure and reconstruction, which may take a number of years, whether they rent or own their final home.</p> <p>Transitional shelters support families in making their own decisions by being designed and constructed in cooperation with them. Using materials for more than one purpose, shelters can be upgraded into part of a permanent house, reused for another purpose or relocated from a temporary site to a permanent location. The materials used in transitional shelters can be resold for capital or recycled into a permanent house.</p> <p>If appropriate to a specific response, the approach should be used only as part of an integrated and comprehensive shelter, settlement and reconstruction strategy.</p>
<b>Urban self-settlement</b>	Urban unclaimed properties or land unaffected by the disaster, used informally by displaced populations.
<b>Vulnerability</b>	Characteristics of a person or group in terms of their capacity to anticipate, cope with, resist and recover from the impact of a natural or man-made hazard.
<b>Vulnerable groups</b>	Groups or members of groups exposed to the impacts of hazards, such as displaced people, women, elderly, disabled and any group subject to discrimination.
<b>Warning systems</b>	Mechanisms used to persuade and enable people and organizations to take actions to increase safety and reduce the impacts of a hazard.

# Acronyms

Acronym	Definition
<b>ALNAP</b>	Active Learning Network for Accountability and Performance in Humanitarian Action
<b>BOQ</b>	bill of quantities
<b>CA</b>	cash approach
<b>CBO</b>	community-based organisation
<b>CCCM</b>	Camp Coordination and Camp Management
<b>CERF</b>	Central Emergency Response Fund
<b>CGI</b>	corrugated galvanised iron
<b>CHAP</b>	Common Humanitarian Action Plan
<b>CHF</b>	Community Housing Foundation
<b>CLA</b>	Cluster Lead Agency
<b>COHRE</b>	Centre on Housing Rights and Evictions
<b>CORDAID</b>	Catholic Organisation for Relief and Development Aid
<b>CSO</b>	civil society organisations
<b>DEC</b>	Disasters Emergency Committee
<b>DFID</b>	Department for International Development (UK Government)
<b>DRM</b>	disaster risk management
<b>DRR</b>	disaster risk reduction
<b>EC</b>	European Commission
<b>ECHO</b>	European Commission Humanitarian Aid and Civil Protection
<b>EIA</b>	environmental impact assessment
<b>EMMA</b>	emergency market mapping and analysis
<b>ERC</b>	Early Recovery Cluster
<b>ESC</b>	Emergency Shelter Cluster
<b>FAO</b>	Food and Agriculture Organization
<b>FI</b>	food item
<b>GCLA</b>	Global Cluster Lead Agency
<b>GIS</b>	geographic information system
<b>HC</b>	Humanitarian Coordinator
<b>IASC</b>	Inter-Agency Standing Committee
<b>ICRC</b>	International Committee of the Red Cross
<b>IDP</b>	internally displaced person
<b>IED</b>	improvised explosive device
<b>IFRC</b>	International Federation of Red Cross and Red Crescent Societies
<b>IGO</b>	inter-governmental organisation
<b>IMWiG</b>	Information Management Working Groups
<b>INGO</b>	international non-governmental organisation

1

definition of TS  
10 TS principles  
5 characteristics  
when not to use TS  
SWOT

definition

2

decision-making tool

tool

3

coordination  
programme plan  
assessment  
beneficiaries  
labour  
materials  
procurement  
support  
quality assurance

programme

4

community  
site selection  
site planning  
land tenure  
handover

site

5

socio-cultural  
minimise risk  
climatic design  
materials  
construction

design

resources

<b>IO</b>	international organisation
<b>IOM</b>	International Organization for Migration
<b>IRC</b>	International Rescue Committee
<b>ISO</b>	International Organization for Standardization
<b>LENSS</b>	local estimate of needs for shelter and settlement
<b>LFA</b>	logical framework approach
<b>LNGO</b>	local non-government organisation
<b>M&amp;E</b>	monitoring and evaluation
<b>NFI</b>	non-food item
<b>NGO</b>	non-governmental organisation
<b>ODI</b>	Overseas Development Institute
<b>ODR</b>	owner-driven reconstruction
<b>OECD</b>	Organisation for Economic Co-operation and Development
<b>ORS</b>	One Room Shelter
<b>RedR</b>	Register of Engineers for Disaster Relief
<b>SAG</b>	Strategic Advisory Group
<b>SWOT</b>	Strengths, Weaknesses, Opportunities, Threats
<b>TOR</b>	terms of reference
<b>TWiG</b>	Technical Working Group
<b>UN</b>	United Nations
<b>UN/ISDR</b>	United Nations International Strategy for Disaster Risk Reduction
<b>UN/OCHA</b>	United Nations Office for the Coordination of Humanitarian Affairs
<b>UNDAC</b>	United Nations Disaster Assessment and Coordination
<b>UNDP</b>	United Nations Development Programme
<b>UNDP CPR</b>	United Nations Development Programme Crisis Prevention and Recovery
<b>UNDRO</b>	United Nations Disaster Relief Organization
<b>UNEP</b>	United Nations Environment Programme
<b>UNESCO</b>	United Nations Educational, Scientific and Cultural Organization
<b>UN-HABITAT</b>	United Nations Human Settlements Programme
<b>UNHCR</b>	United Nations High Commissioner for Refugees
<b>UNHRP</b>	United Nations Housing Rights Programme
<b>UNICEF</b>	United Nations Children's Fund
<b>USAID</b>	United States Agency for International Development
<b>UXO</b>	unexploded ordnance
<b>WASH</b>	water, sanitation and hygiene
<b>WEF</b>	World Economic Forum
<b>WFP</b>	World Food Programme
<b>WHO</b>	World Health Organization

# Annotated Bibliography

## International Federation of the Red Cross and Red Crescent Societies, 2011



### *Transitional shelters—Eight designs*

[www.ifrc.org](http://www.ifrc.org)

[www.sheltercentre.org/library/transitional-shelters—eight-designs](http://www.sheltercentre.org/library/transitional-shelters—eight-designs)

Topics	Transitional shelter context and design Case study analysis Typical design details
Subject	This publication has been produced to respond to the need for transitional shelter solutions in emergencies in providing a “menu” of engineered, quantified and costed solutions drawn upon existing models already used in the field. This menu covers a variety of different contexts and climates, with practical guidance on how each solution could or should be amended to meet the requirements of a specific emergency.  As the document highlights, providing a defined shelter “product” such as those described is but one of several means of meeting shelter and settlement needs after disaster.

## The Sphere Project, 2011



### *The Sphere Project: Humanitarian Charter and Minimum Standards in Humanitarian Response (Third edition)*

[www.sphereproject.org](http://www.sphereproject.org)

[www.sheltercentre.org/library/sphere-handbook-2011-humanitarian-charter-and-minimum-standards-disaster-response](http://www.sheltercentre.org/library/sphere-handbook-2011-humanitarian-charter-and-minimum-standards-disaster-response)

Topics	The Sphere Project philosophy, approach and values The Humanitarian Charter Protection principles and standards
Subject	The Sphere Project and its handbook frame a humanitarian charter, identify a set of minimum standards in key life-saving sectors and consolidate their core standards. In the 2011 revision, the Humanitarian Charter has been completely re-written, the common standards have changed significantly and a stronger focus on protection has been introduced.  Sphere is based on two core beliefs: first, that all possible steps should be taken to alleviate human suffering arising out of calamity and conflict, and second, that those affected by disaster have a right to life with dignity and therefore a right to assistance.

1

definition of TS  
10 TS principles  
5 characteristics  
when not to use TS  
SWOT

definition

2

decision-making tool

tool

3

coordination  
programme plan  
assessment  
beneficiaries  
labour  
materials  
procurement  
support  
quality assurance

programme

4

community  
site selection  
site planning  
land tenure  
handover

site

5

socio-cultural  
minimise risk  
climatic design  
materials  
construction

design

resources

## United Nations, 2010

---



### ***Shelter after Disaster***

[www.un.org](http://www.un.org)

[www.sheltercentre.org/library/shelter-after-disaster](http://www.sheltercentre.org/library/shelter-after-disaster)

---

**Topics**      Response coordination and strategy  
Programme assessment and implementation  
Toolkits

---

**Subject**      The publication offers governments, coordinators and implementers a framework for integrated shelter, settlement and reconstruction following natural disasters.

The guidelines were revised with the consensus of the Shelter Meeting, and the key approach is also published both in the World Bank Handbook and The Sphere Project. The revision is of the 1982 edition, *Shelter after Disaster: Guidelines for Assistance*.

This framework is intended to be consistent with government structures and humanitarian coordination mechanisms, supporting both in developing and implementing a single strategy, policy or plan for each response.

---

## The World Bank, 2010

---



### ***Safer Homes, Stronger Communities: A Handbook for Reconstructing after Natural Disasters***

[www.worldbank.org](http://www.worldbank.org)

[www.sheltercentre.org/library/safer-homes-stronger-communities-handbook-reconstructing-after-natural-disasters](http://www.sheltercentre.org/library/safer-homes-stronger-communities-handbook-reconstructing-after-natural-disasters)

---

**Topics**      Reconstruction tasks and how to undertake them  
Monitoring and information management  
Information of World Bank projects and policies  
Technical references

---

**Subject**      This handbook gives policy-makers and project managers the information they need to plan and carry out housing and community reconstruction projects, empowering communities affected by disasters and reducing their vulnerability to future disasters.

The handbook includes nearly 100 case studies collected from global experts with recent experience in housing reconstruction, illustrating how the recommended policies and practical approaches have been used in the field.

Designed to provide immediate guidance in post-disaster reconstruction settings, the publication is a vital resource for policy-makers and project managers, and for all practitioners involved in post-disaster housing, community reconstruction and disaster risk management.

---

## References

Books, journals and publications can be downloaded from the Shelter Centre library, [www.sheltercentre.org/library](http://www.sheltercentre.org/library)

### Books/journals/publications

ALNAP, 2006. *Evaluating Humanitarian Action Using the OECD-DAC Criteria: An ALNAP Guide for Humanitarian Agencies*, London.

ALNAP, 2010. *ALNAP Innovations - Case Study No.5: Transitional Shelter: Understanding shelter from the emergency through reconstruction and beyond*.

ALNAP and ProVention Consortium, 2005. *South Asia Earthquake 2005: Learning from previous earthquake relief operations*, London, ALNAP.

Auliciems, A. and Szokolay, S.V., 2007. *Thermal Comfort*, Second edition, Brisbane: PLEA (Passive and Low Energy Architecture International) and the Department of Architecture, The University of Queensland.

Batchelor, V., 2011. *Tarpaulins, Transitional Shelters or Permanent Houses: How Does the Shelter Assistance Provided Affect the Recovery of Communities After Disaster?* Centre for Development and Emergency Practice.

Capacity Development Group, 2005. *A Brief Review of 20 Tools to Assess Capacity*. Bureau for Development Policy, UNDP Resource Catalogue.

Centre on Housing Rights and Evictions (COHRE), 2005. *The Pinheiro Principles: United Nations Principles on Housing and Property Restitution for Refugees and Displaced Persons*, Geneva.

Centre on Research on Equality, Human Security and Ethnicity, 2007. *Cultural Status Inequalities: an Important Dimension of Group Mobilisation*, CRISE working paper no. 41, Oxford, CRISE.

Crawford, K. et al., 2010. "Coordination And The Tenure Puzzle In Haiti" in *Humanitarian Exchange Magazine*, London, Overseas Development Institute (ODI).

Cooke, R., 2007. *Building In The 21st Century*, Oxford: Blackwell Publishing Ltd.

DEC and Ove Arup Partners Ltd, 2010. *Lessons from Aceh: Key Considerations in Post-Disaster Reconstruction*, Rugby, Practical Action Publishing.

DFID, 2011. *Humanitarian Emergency Response Review (HERR)*. HERR.

Dickinson, P. R., 2004. *Cracking and Building Movement*, Coventry: RICS Business Services Limited.

Food and Agriculture Organization (FAO), 2002. *Land tenure and rural development*, Land Tenure Studies 3, Rome.

Food and Agriculture Organization (FAO), 2002. *Gender and access to land*, Land Tenure Studies 4, Rome.

Grantmakers Without Borders, 2006. *Tsunami Learning Project: Lessons for Grantmakers in Natural Disaster Response*, San Francisco, Grantmakers Without Borders.

IASC, 2006. *Women, Girls, Boys and Men: Different Needs - Equal Opportunities*.

IASC, 2007. *Exit Strategy for Humanitarian Actors in the Context Of Complex Emergencies*.

IASC, 2008. *Selecting NFIs for Shelter*, Geneva, Shelter Centre.

IASC, 2010. *Cluster Approach Evaluation 2: Synthesis Report*, Berlin.

ICRC/IFRC, 2008. *Guidelines for assessment in emergencies*, Geneva.

1

definition of TS

10 TS principles

5 characteristics

when not to use TS

SWOT

2

decision-making tool

3

coordination

programme plan

assessment

beneficiaries

labour

materials

procurement

support

quality assurance

4

community

site selection

site planning

land tenure

handover

5

socio-cultural

minimise risk

climatic design

materials

construction

definition

tool

programme

site

design

resources

- 
- IFRC, 2010. *Owner-Driven Housing Reconstruction Guidelines*, Geneva.
- 
- IFRC, 2011. *Addressing Regulatory Barriers to Providing Emergency and Transitional Shelter in a Rapid and Equitable Manner After Natural Disasters*. 31<sup>st</sup> International Conference of the Red Cross and Red Crescent, Background report, Geneva.
- 
- IFRC et al., 2011. *Emergency Shelter and Cash-Based Programming Training Module*. Version 1, IFRC, Cash Learning Programme (CaLP), Oxfam GB, Shelter Forum.
- 
- IFRC, 2011. *PASSA: Participatory Approach for Safe Shelter Awareness*, Geneva.
- 
- IFRC, 2011. *Transitional Shelters: Eight Designs*, Geneva.
- 
- INEE, 2010. *Minimum Standards for Education: Preparedness, response, recovery*, 2nd edition, New York.
- 
- Institute of Development Studies, 1995. *Gender, Emergencies and Humanitarian Assistance. Report Commissioned by the WID Desk, European Commission, Directorate General for Development. Report No. 33*, Brighton, BRIDGE (development-gender), University of Sussex.
- 
- International Institute for Sustainable Development (IISD), 2006. *Addressing Land Ownership After Natural Disasters: An Agency Survey*, Winnipeg.
- 
- International NGO Training and Research Centre (INTRAC), 1995. *Participatory Self Assessment of NGO Capacity: Occasional Papers Series No:10*.
- 
- International Save the Children Alliance, 2005. *Programme Management Best Practice*, London.
- 
- IOM, 2011. Version 1. *ORS - One Room Shelter Programme Manual*.
- 
- Langer, A., 2006. *Cultural Status Inequalities: How Perceived Differences in Cultural Recognition can Act as an Incentive for Violent Mobilisation*. Issue Two. Oxford, Centre for Research on Inequality, Human Security and Ethnicity (CRISE).
- 
- van Lengen, J. 2008. *The Barefoot Architect: A Handbook for Green Building*, California, Shelter Publications, Inc.
- 
- Lloyd-Jones T. et al., 2009. *The Built Environment Professions in Disaster Risk Reduction and Response: A Guide for Humanitarian Agencies*, Westminster, MLC Press.
- 
- Max Lock Centre, 2009. *The Built Environment Professions in Disaster Risk Reduction and Response: a guide for humanitarian agencies*, London, MLC Press, University of Westminster.
- 
- Médecins Sans Frontières and Shelter Centre, 2006. *Shade Nets: use, deployment and procurement, of shade net in humanitarian relief environments*, Geneva, Shelter Centre.
- 
- Médicos Sin Fronteras (MSF), 2011. *Small Constructions Manual*, Version 1.0, Barcelona.
- 
- ODI, 2003. *Participation By Crisis-Affected Populations in Humanitarian Action: A Handbook for Practitioners*, London, ALNAP.
- 
- ODI, 2009. *Research and Policy Development:SWOT analysis*, London, ODI.
- 
- Oxfam GB, 2010. *Emergency Market Mapping and Analysis Toolkit*, Rugby, Practical Action Publishing.
- 
- Payne, G., 1997. *Urban Land Tenure And Property Rights In Developing Countries*, London, The Overseas Development Administration.
- 
- Practical Action, 1996. *Transitional Shelter: Essential Criteria To Be Met*, Rugby.
- 
- Practical Action, 2007. *Chimney Stoves and Smoke Hoods*, Technical brief, Rugby.
- 
- Practical Action, 2008. *Managing Humanitarian Relief*, Rugby.
- 
- ProAct network and Shelter Centre, 2009. *Asbestos in Emergencies: Safer Handling and Breaking the Cycle*, Shelter Centre, Geneva, Shelter Centre.
-



Rosenlund, H., 2000. "Climatic Design of Buildings Using Passive Techniques" in <i>Building Issues 2000</i> , Volume 10, Number 1, Sweden, Lund University.	1	definition
Shelterproject.org, 2003. <i>Report on the Transitional Settlement Sector</i> , Cambridge, University of Cambridge.	definition of TS	
Shelter Centre, 2010. <i>Transitional Shelter Standards 10b, draft</i> , Geneva.	10 TS principles	
Smith, A. H. et al., 2000. "Contamination Of Drinking-Water By Arsenic In Bangladesh: A Public Health Emergency" in <i>Bulletin of the World Health Organization</i> , 2000, 78 (9), World Health Organization (WHO).	5 characteristics	
The Sphere Project, 2011. <i>The Sphere Handbook: Humanitarian Charter and Minimum Standards in Humanitarian Response</i> , Third edition, Rugby, Practical Action Publishing.	when not to use TS	
UNEP and SKAT, 2007. <i>After The Tsunami: Sustainable building guidelines for South-East Asia</i> , Nairobi.	SWOT	
UN-HABITAT, 2007. <i>Sustainable Relief and Reconstruction - Synopsis from World Urban Forum II &amp; III: From Conceptual Framework to Operational Reality</i> , Nairobi.	2	tool
UN-HABITAT, 2009. <i>LENS Tool Kit: Local Estimate of Needs For Shelter and Settlement: Field Version</i> , Nairobi.	decision-making tool	
UN-HABITAT, 2010. <i>Count Me In: Surveying for tenure security and urban land management</i> , Nairobi.	3	programme
UN-HABITAT, 2010. <i>Land and Natural Disasters: Guidance for Practitioners</i> , Nairobi.	coordination	
UN-HABITAT, 2010. <i>Strategic Citywide Spatial Planning: A Situational Analysis of Metropolitan Port-au-Prince, Haiti</i> .	programme plan	
UN-HABITAT and IFRC, 2010. <i>Shelter Projects 2009</i> , Nairobi, UN-HABITAT.	assessment	
UN-HABITAT and IFRC, 2011. <i>Shelter Projects 2010</i> , Nairobi, UN-HABITAT.	beneficiaries	
UN-HABITAT, UNHCR and IFRC. 2008. <i>IASC Emergency Shelter Cluster: Shelter Projects 2008</i> , Nairobi, UN-HABITAT.	labour	
UNHCR, 2005. <i>Transitional Shelter Quality, Standards and Upgrading Guidelines</i> , Geneva.	materials	
UNHCR, 2006. <i>The UNHCR Tool for Participatory Assessment in Operations</i> , Geneva.	procurement	
UNHCR, 2007. <i>Handbook for Emergencies</i> , Third Edition, Geneva.	support	
University of Cambridge, 2005. <i>Transitional Settlement Displaced Populations</i> , Oxford, Oxfam Publishing.	quality assurance	
UN/OCHA, 2005. <i>Humanitarian Response Review</i> , Geneva.	4	site
UN/OCHA, 2010. <i>Shelter after disaster</i> , Geneva, DFID and Shelter Centre.	community	
UN/OCHA , IFRC and CARE International, 2009. <i>Timber - A guide to the planning, use, procurement and logistics of timber as a construction material in humanitarian relief</i> .	site selection	
Warwick, H. and Doig, A., 2004. <i>Smoke - the Killer in the Kitchen: Indoor Air Pollution in Developing Countries</i> , London: ITDG Publishing.	site planning	
The World Bank, 2010. <i>Safer Homes, Stronger Communities: A Handbook for Reconstructing after Natural Disasters</i> , Washington.	land tenure	
	handover	
	5	design
	socio-cultural	
	minimise risk	
	climatic design	
	materials	
	construction	
<b>In-house publications</b>		
Caritas/Cordaid, 2010. <i>Haiti earthquake, 2010—Shelter design with the community, Caritas/Cordaid</i> .		
IOM, 2010. <i>IOM Haiti—Transitional Shelter Program</i> , IOM.		

## Internet resources

---

Active Learning Network for Accountability and Performance in Humanitarian Action (ALNAP), '*Homepage*'. [online] Available at: [www.alnap.org](http://www.alnap.org)

---

clustercoordination.org, '*Information Management Working Group*'. [online] Available at: [www.clustercoordination.org/imwig](http://www.clustercoordination.org/imwig)

---

Centre on Housing Rights and Eviction (COHRE), '*Homepage*'. [online] Available at: [www.cohre.org](http://www.cohre.org)

---

clustercoordination.org, '*Strategic Advisory Group*'. [online] Available at: [www.clustercoordination.org/sag](http://www.clustercoordination.org/sag)

---

clustercoordination.org, '*Technical Working Group*'. [online] Available at: [www.clustercoordination.org/twig](http://www.clustercoordination.org/twig)

---

Cordaid, '*Homepage*'. [online] Available at: [www.cordaid.com](http://www.cordaid.com)

---

Cordaid Haiti, '*Result Update: September 2011*'. [online] Available at: [www.cordaidhaiti.org/2011/10/result-update-september-2011](http://www.cordaidhaiti.org/2011/10/result-update-september-2011)

---

Department for International Development (DFID), '*Homepage*'. [online] Available at: [www.dfid.gov.uk](http://www.dfid.gov.uk)

---

Department for International Development (DFID), '*Earthquake In Haiti*'. [online] Available at: [www.dfid.gov.uk/Media-Room/News-Stories/2010/Haiti-Earthquake](http://www.dfid.gov.uk/Media-Room/News-Stories/2010/Haiti-Earthquake)

---

Disaster Assessment Portal, '*Homepage*'. [online] Available at: [www.disasterassessment.org](http://www.disasterassessment.org)

---

Emergency Shelter Cluster, '*Humanitarian Reform: Accountability, Predictability, Leadership, Partnership*'. [online] Available at: [www.onerresponse.info/GLOBALCLUSTERS/EMERGENCY%20SHELTER/Pages/default.aspx](http://www.onerresponse.info/GLOBALCLUSTERS/EMERGENCY%20SHELTER/Pages/default.aspx)

---

Food and Agriculture Organization (FAO), '*Homepage*'. [online] Available at: [www.fao.org](http://www.fao.org)

---

Global Facility for Disaster Reduction and Recovery (GFDRR), '*Homepage*'. [online] Available at: [www.gfdr.org](http://www.gfdr.org)

---

Handicap International, '*Haiti Situation Update: Nine Months Of Action By Handicap International*'. Updated: 10/14/2010. [online] Available at: [www.alnap.org/pool/files/oct-14-haiti-sitrep.pdf](http://www.alnap.org/pool/files/oct-14-haiti-sitrep.pdf)

---

Help Age International, '*Homepage*'. [online] Available at: [www.helpage.org](http://www.helpage.org)

---

Humanitarian Accountability Partnership, '*Homepage*'. [online] Available at: [www.hapinternational.org](http://www.hapinternational.org)

---

Humanitarian Bamboo, '*Homepage*'. [online] Available at: [www.humanitarianbamboo.org](http://www.humanitarianbamboo.org)

---

Humanitarian Practice Network (HPN), '*Homepage*'. [online] Available at: [www.odihpn.org](http://www.odihpn.org)

---

Inter-Agency Standing Committee (IASC), '*Haiti Shelter Cluster*'. [online] Available at: [www.sites.google.com/site/shelterhaiti2010](http://www.sites.google.com/site/shelterhaiti2010)

---

Inter-Agency Standing Committee (IASC), '*Homepage*'. [online] Available at: [www.humanitarianinfo.org/iasc/](http://www.humanitarianinfo.org/iasc/)

---

Inter-Agency Standing Committee (IASC), '*ShelterCluster.org*'. [online] Available at: [www.sheltercluster.org](http://www.sheltercluster.org)

---

Internal Displacement Monitoring Centre (IDMC), '*Homepage*'. [online] Available at: [www.internal-displacement.org](http://www.internal-displacement.org)

---

The International Disaster Database (EM-DAT), '*Homepage*'. [online] Available at: [www.emdat.be/](http://www.emdat.be/)

---

International Federation Of Red Cross And Red Crescent (IFRC), '*Homepage*'. [online] Available at: [www.ifrc.org](http://www.ifrc.org)

---

<p><b>International Institute for Environment and Development (IIED), 'Homepage'. [online]</b> Available at: <a href="http://www.iied.org">www.iied.org</a></p>	<p>1</p>	<p>definition</p>
<p><b>International Organization for Migration (IOM), 'Haiti's Earthquake Survivors Voice Their Hopes And Fears' (The Guardian). [online]</b> Available at: <a href="http://www.iomhaiti.com/ft/page.php?id=42">www.iomhaiti.com/ft/page.php?id=42</a></p>	<p>definition of TS 10 TS principles</p>	
<p><b>International Save the Children Alliance, 'Programme Management Best Practice' [Online]</b> Available at: <a href="http://www.savethechildren.net/alliance/about_us/accountability.html">http://www.savethechildren.net/alliance/about_us/accountability.html</a></p>	<p>5 characteristics when not to use TS</p>	
<p><b>Overseas Development Institute (ODI), 'Swot Analysis'. [Online] Research and Policy in Development Paper.</b> Available at: <a href="http://www.odi.org.uk/rapid/events/smepol_egypt/docs/swot_analysis.pdf">http://www.odi.org.uk/rapid/events/smepol_egypt/docs/swot_analysis.pdf</a></p>	<p>SWOT</p>	
<p><b>Logistics Cluster, 'Homepage'. [online]</b> Available at: <a href="http://www.logcluster.org">www.logcluster.org</a></p>	<p>2</p>	<p>tool</p>
<p><b>One Response, 'Coordination: Cluster Approach'. [online]</b> Available at: <a href="http://www.oneresponse.info">www.oneresponse.info</a></p>	<p>decision-making tool</p>	
<p><b>Overseas Development Institute, 'Homepage'. [online]</b> Available at: <a href="http://www.odi.org.uk">www.odi.org.uk</a></p>	<p>3</p>	<p>programme</p>
<p><b>Practical Action, 'Document Library'. [online]</b> Available at: <a href="http://www.practicalaction.org">www.practicalaction.org</a></p>	<p>coordination</p>	
<p><b>Practical Action, 'Quincha Earthquake-resistant Housing'. [online]</b> Available at: <a href="http://www.practicalaction.org/earthquake_resistant_housing">www.practicalaction.org/earthquake_resistant_housing</a></p>	<p>programme plan</p>	
<p><b>Relief Web, 'Homepage'. [online]</b> Available at: <a href="http://www.reliefweb.int">www.reliefweb.int</a></p>	<p>assessment</p>	
<p><b>Relief Web, 'Haiti: Unclear Land Rights Hinder Haiti's Reconstruction'. [online]</b> Available at: <a href="http://www.reliefweb.int/node/360009">www.reliefweb.int/node/360009</a></p>	<p>beneficiaries</p>	
<p><b>Shelter Centre, 'Shelter Library'. [online]</b> Available at: <a href="http://www.sheltercentre.org/library">www.sheltercentre.org/library</a></p>	<p>labour</p>	
<p><b>The Sphere Project, 'Homepage'. [online]</b> Available at: <a href="http://www.sphereproject.org">www.sphereproject.org</a></p>	<p>materials</p>	
<p><b>United Nations (UN), 'Homepage'. [online]</b> Available at: <a href="http://www.un.org">www.un.org</a></p>	<p>procurement</p>	
<p><b>United Nations Development Programme (UNDP), 'Homepage'. [online]</b> Available at: <a href="http://www.undp.org">www.undp.org</a></p>	<p>support quality assurance</p>	
<p><b>United Nations Educational, Scientific and Cultural Organization (UNESCO), 'Homepage'. [online]</b> Available at: <a href="http://www.unesco.org">www.unesco.org</a></p>	<p>4</p>	<p>site</p>
<p><b>United Nations Environmental Programme (UNEP), 'Homepage'. [online]</b> Available at: <a href="http://www.unep.org">www.unep.org</a></p>	<p>community</p>	
<p><b>United Nations Human Settlements Programme (UN-HABITAT), 'Homepage'. [online]</b> Available at: <a href="http://www.unhabitat.org">www.unhabitat.org</a></p>	<p>site selection site planning</p>	
<p><b>United Nations High Commissioner for Refugees (UNHCR), 'Haiti: IDPs Face Eviction As Passing Storm Highlights Ongoing Vulnerability'. [online]</b> Available at: <a href="http://www.unhcr.org/refworld/country,,,HT1,,4e4a1c322,0.html">www.unhcr.org/refworld/country,,,HT1,,4e4a1c322,0.html</a></p>	<p>land tenure handover</p>	
<p><b>United Nations International Strategy for Disaster Risk Reduction (UN/ISDR), 'Homepage'. [online]</b> Available at: <a href="http://www.unisdr.org">www.unisdr.org</a></p>	<p>5</p>	<p>design</p>
<p><b>Office for the Coordination of Humanitarian Affairs (UN/OCHA), 'Humanitarian Reform'. [online]</b> Available at: <a href="http://ochaonline.un.org/roap/WhatWeDo/HumanitarianReform/tabid/4487/Default.aspx">http://ochaonline.un.org/roap/WhatWeDo/HumanitarianReform/tabid/4487/Default.aspx</a></p>	<p>socio-cultural minimise risk climatic design</p>	
<p><b>Office for the Coordination of Humanitarian Affairs (UN/OCHA), 'One Response'. [online]</b> Available at: <a href="http://www.oneresponse.info/">www.oneresponse.info/</a></p>	<p>materials construction</p>	
<p><b>The World Bank, 'El Salvador: Earthquake Reconstruction And Health Services Extension Project (RHESSA)'. [online]</b> Available at: <a href="http://web.worldbank.org/WBSITE/EXTERNAL/COUNTRIES/LACEXT/ELSALVADOREXTN0,,contentMDK:21331021~pagePK:1497618~piPK:217854~theSitePK:295244,00.html">http://web.worldbank.org/WBSITE/EXTERNAL/COUNTRIES/LACEXT/ELSALVADOREXTN0,,contentMDK:21331021~pagePK:1497618~piPK:217854~theSitePK:295244,00.html</a></p>	<p>resources</p>	
<p><b>The World Bank, 'Homepage'. [online]</b> Available at: <a href="http://www.worldbank.org">www.worldbank.org</a></p>		
<p><b>World Health Organization (WHO), 'Homepage'. [online]</b> Available at: <a href="http://www.who.int">www.who.int</a></p>		

## **Shelter Meeting resources**

---

All Shelter Meeting resources and presentations can be downloaded from the Shelter Centre website, [www.sheltercentre.org/meeting/past](http://www.sheltercentre.org/meeting/past)

---

# Index

## A

- access to land** *see land tenure*
- accessibility** 125, 128, 145–146
- accommodation** 157
- accounting** 25, 51
- Aceh** 14, 79, 99
- administrative assistance** 41, 93
- advocacy assistance** 25, 35, 93
- affected population** 110, 112–113, 123, 124, 126–128, 133, 140–146, 180
- age** 113
- agency**  
national *see national agency*  
international *see international agency*
- analysis tool**  
emergency market mapping and analysis (EMMA) *see EMMA*  
strengths, weaknesses, opportunities and threats (SWOT) *see SWOT*
- anchor foundations** 153, 182–184
- anchoring** 153
- apartment** 125  
owner-occupier 5, 21  
tenant 5, 21
- area** 133  
conflict *see conflict area*  
sensitive 42
- assessment** 23, 112, 117, 121, 130  
*see also monitoring and evaluation*  
damage *see damage assessment*  
emergency *see emergency assessment*  
environmental *see environmental assessment*  
hazard and risk *see hazard assessment*  
information 93, 99  
joint *see joint assessment*  
livelihood *see livelihood assessment*  
market *see market assessment*  
needs *see needs assessment*  
participation 58, 138, 140  
preliminary *see preliminary assessment*  
rapid 56, 57, 105  
stages 56  
strategy 45  
UNHCR Tool for Participatory Assessment in Operations 58
- assistance** 35, 62, 64, 70, 76, 111, 113  
18 methods 68, 69  
administrative *see administrative assistance*  
advocacy 93  
financial *see financial assistance*  
legal *see legal assistance*  
level 67  
shelter *see shelter assistance*  
strategy 35, 54, 65, 67  
technical *see technical assistance*

## B

- bamboo** 173–176, 188–189, 193
- Bangladesh** 121
- beneficiary identification** 64, 66, 136
- bracing** 152, 169, 175, 189–191
- building** 120, 128  
codes and standards 11, 40, 90, 103, 106, 107, 138  
damage 47, 60, 97, 150  
construction *see construction principles*  
materials 76, 82, 160, 168–179  
plan 151  
safe *see safe building*  
traditions 72–74, 108, 138, 180, 181, 189

## C

- camp** 43, 99, 117, 121, 122, 128  
planned *see planned camp*  
self-settled *see self-settled camp*
- camp coordination and camp management cluster** 31, 33, 34, 35
- capacity** 86, 126, 127  
assessment 47, 62, 98  
building 27, 62, 69, 71, 98  
government *see government capacity*  
local *see local capacity*  
technical *see technical capacity*
- cash** 28, 67, 69, 90, 131  
distribution 31, 111
- cement** 148–149, 177–179, 213
- characteristics of transitional shelter** 15–16
- climate** 112, 125, 152, 157, 159–167  
cold *see cold climate*  
hot-dry *see hot-dry climate*  
warm-humid *see warm-humid climate*
- climatic design** 136, 159–168
- clothing** 159–160
- cluster** 127, 136  
approach 33  
emergency shelter 142  
global 34
- cold climate** 128, 159–167
- collective centre** 4, 21, 24
- communal** 142  
facilities 142–148  
infrastructure 110, 123, 125, 126, 136, 170  
services 115, 123, 125–126, 145–148
- communication** 35, 39, 42  
methods 43, 138–145  
strategy 40, 138–145
- community** 23, 27, 123, 126, 133, 135–146  
affected *see affected population*  
considerations 35, 96, 102, 138–140  
consultation 42, 46, 120, 138–139, 145  
group 98, 139–141  
labour 71, 139

1

definition  
10 TS principles  
5 characteristics  
when not to use TS  
SWOT

2

tool  
decision-making tool

3

programme  
coordination  
programme plan  
assessment  
beneficiaries  
labour  
materials  
procurement  
support  
quality assurance

4

site  
community  
site selection  
site planning  
land tenure  
handover

5

design  
socio-cultural  
minimise risk  
climatic design  
materials  
construction

definition

tool

programme

site

design

resources

involvement 11, 123, 138–146, 170  
participation 66, 99, 102, 123, 124, 128,  
138–140, 143–146  
site selection and planning 126, 127  
support 56, 138–145

**competitive procurement** 83, 85

**concrete** 151, 169, 177, 183–185, 188, 191  
floor 169, 177, 186–188

**conflict** 110, 112, 113, 126, 127, 130  
area 117, 122, 152, 157, 160, 168–180

**construction** 39, 62, 120, 140–141, 147,  
149, 158, 181–194  
industry 49  
materials *see building materials*  
principles 75, 125, 127, 128, 136, 141,  
147–151, 157, 180–194  
techniques 60, 126, 144, 147, 149–151,  
157, 180–194

**consultant** 70

**context**  
cultural *see cultural context*  
humanitarian *see humanitarian context*  
local *see local context*

**contingency plan** 35, 42, 46, 51, 105

**contour planning** 124

**contract labour** 72, 92

**cooking** 116, 126, 138–139, 156, 167

**coordinated response** 31, 145

**coordination** 114, 134  
body 36, 171  
effective 32  
framework 37  
inter-sectoral *see inter-sectoral  
coordination*  
mechanism 38–39  
meeting 35–37, 46  
strategy 21  
structure 31  
team 37, 180

**coordination tool**  
critical path analysis *see critical path  
analysis*  
gant chart *see gantt chart*  
logical framework approach *see LFA*

**CORE housing** 8, 18

**corrugated galvanised iron (CGI)** 152,  
172–173

**cost** 6–7, 134, 147, 150, 168

**country**  
affected 138–146

**critical path analysis** 53

**cultural context** 59, 129, 137–146

**customs** 138–139

**cyclone** *see hurricane*

---

## D

**damage** 119  
assessment 40, 57, 60  
building *see building damage*  
types of 153, 163, 173, 191

**debris** 118, 121, 148, 150, 154, 183–184

**deforestation** 118, 150

**design**  
climatic *see climatic design*  
to minimise risk 147–158  
with the community 138–144

**development assistance committee (DAC)**

**criteria for monitoring and evaluation** 100

**development process** 169

**differential settlement** 181

**direct labour** 70

**disaster** 21, 110, 112, 115, 127, 131–132  
response 113, 126, 130

**disaster risk reduction (DRR)** 59, 103, 124,  
147–158

**disease** 120, 121, 128, 155, 167

**displaced population** 21, 24, 112, 114–115,  
122, 130

**distribution**  
chain 115, 125

**donor** 36

**drainage** 110, 116–118, 123, 125, 150, 162,  
164, 167, 186, 193

---

## E

**earth** 178  
floor 186  
stabilised 178  
walls 189

**earthquake** 117, 118  
resilience 151–152  
prone 118, 119, 151

**economy**  
local *see local economy*

**El Salvador** 142

**Early Recovery Cluster** 33

**education** 127

**emergency**  
assessment 47  
needs 78  
response 50  
plan 44, 46, 54, 93  
services 125, 148  
shelter 142  
shelter cluster 33, 34

**emergency market mapping and analysis (EMMA)** 63, 86

**environment** 126, 128, 159–167

**environmental** 117, 120  
assessment 59, 62, 63, 95  
benefit 143  
damage 62  
degradation 125  
impact 31, 77, 78, 79, 83, 159  
management 28, 34, 62, 69, 95  
resources 95, 114

**evacuation** 120  
area 60, 148  
route 88, 117, 120, 157

**evaluation** 120, 121  
independent 103  
technical 103

**excessive settlement** 181

**exit strategy** 54

## F

- family** 136
  - composition 141
  - structure 141
- financial**
  - assistance 61
- fire** 117
  - prevention 157
  - safety distance 157
- flood** 121, 124
  - resilience 148
  - prone 117, 118, 156
- floor**
  - concrete *see concrete floor*
  - earth *see earth floor*
  - suspended *see suspended floor*
- financial assistance** 61
- food** 119
- foundations** 117, 181
  - anchor *see anchor foundations*
  - pad *see pad foundations*
  - slab *see slab foundations*
  - strip *see strip foundations*
- frost heave** 181
- fuel** 156, 166
- funding** 6, 25, 50

## G

- Gantt chart** 53
- gender** 113, 127, 131
  - analysis 141
  - issues 141
  - roles 141
- geographical information systems (GIS) manager** 195
- Global Cluster Lead Agency (GCLA)** 33
- government** 111, 114, 122, 131, 132, 135, 136
  - capacity 54
  - local *see local government*
  - national *see national government*

## H

- Haiti** 8, 12, 14, 39, 43, 65, 103, 144, 145
- handover** 135, 136
- hazard** 113–115, 120, 123, 124
  - assessment 57, 59, 103, 106, 117, 121, 147
  - mapping 60, 110, 124, 123
  - man-made 117
  - natural *see natural hazard*
  - risk reduction 147, 168, 169
  - resistance 26, 147, 150
- health** 112, 116, 121, 123, 126, 128
  - considerations 155–156, 159, 160
- heating** 139, 156, 159
- host**
  - family 4, 21
  - population 114, 122, 123

- hot-dry climate** 159, 164–166
- house** 125
  - permanent 144, 182
  - owner-occupier 5, 21
  - tenant 5, 21
- household** 113, 129–133, 136, 138, 139–141
- human**
  - resources 48
  - rights 132
- humanitarian** 125
  - context 129
  - representative 140
  - response 138
  - stakeholder 111, 114
- humidity** 160–161, 165, 166–167
- hurricane** 119, 120
  - prone 119, 120, 147, 152–154, 173, 193

## I

- implementation** 113, 135
  - problems and constraints 60
- incremental process** 3, 23, 150
- indicators** 169
- information** 122, 130, 133
  - centre 93
  - management 40–43
  - pack 40, 42
  - services 98
  - sharing 40, 58, 98
- IMWiG (information management working group)** 36
- infrastructure** 116, 123–128
  - communal *see communal infrastructure*
- Ingushetia** 90
- insects** 120, 148, 155, 156
- institution** 120
- insulation** 152, 160, 162, 165, 166
- Inter-Agency Standing Committee (IASC)** 21, 33, 127
- internal**
  - conditions 159
  - space 26, 139, 167
- internally displaced person (IDP)** 34, 39, 65, 157
- international**
  - codes and standards 127
- interstitial condensation** 162, 163, 165, 167

## J

- Jogyakarta** 12, 14
- joint assessment** 58

## K

- Kenya** 99
- kit** 130

1

definition  
of TS  
10 TS principles  
5 characteristics  
when not to use TS  
SWOT

2

decision-making tool

3

programme  
coordination  
programme plan  
assessment  
beneficiaries  
labour  
materials  
procurement  
support  
quality assurance

4

site  
community  
site selection  
site planning  
land tenure  
handover

5

design  
socio-cultural  
minimise risk  
climatic design  
materials  
construction

definition

tool

programme

site

design

resources

---

## L

### labour

- community *see community labour*
- contract *see contract labour*
- direct *see direct labour*
- methods 22, 70–74
- self-help *see self-help labour*

### land

- 114, 116, 124, 125, 127, 129–131, 133, 134
- allocation 94
- identification 129, 133
- owner 114, 117, 125, 132–134
- registration 133
- rights 31, 59, 129, 136, 182, 184
- tenant 5, 21, 24, 131
- tenure 7, 94, 101, 128–130, 136, 159

### landslide

- 115, 117, 118, 122, 124, 130
- resilience 150
- prone 118

### laws

- international *see international laws*
- national *see national laws*

### legal

- assistance 38, 66, 93
- framework 73, 129, 132
- responsibility 65–66, 135
- rights 114

### lifespan

- 77, 144, 159

### lighting

- 139

### livelihood

- 114
- activity 111, 140
- assessment 61, 112, 120, 124
- opportunities 78, 110, 123
- support 96, 112, 115, 120, 125–126, 127, 129–130

### loans

- 28, 91

### local

- 122, 126
- authority 124, 128, 135, 136
- capacity 49, 50, 56, 111, 124
- community 158
- context 143
- economy 77, 78
- government 112, 134
- information centre 28
- materials 78, 143, 152, 155, 160, 169
- market 112
- partner 50
- resources 143

### logistics

- capacity 49

### logical framework approach (LFA)

mapping and analysis 92

systems 85

support 28, 86

### masonry

149, 151, 184–185, 188–190, 192

### materials

- 110, 127, 128, 136
- building *see building materials*
- distribution 111
- local *see local materials*
- methods 22, 76
- procurement 82
- shelter *see shelter materials*
- sourcing 77–80
- storage 125

### medical

staff 128

### meteorological data

159

### mines

122

### mitigation

123

measures 147

plan 124, 147

### monitoring

99–102, 111, 120

### mortar

149, 155, 177–179

### mosquitoes

120, 148, 155

### mud

118

bricks 189

---

## N

### national

government 133

laws 65

### natural

hazard 117, 147, 181

resources 115, 125, 126, 143

ventilation 154

### needs assessment

46, 82, 113, 130

### non-food item (NFI)

77

procurement 82, 84–88, 96

shelter *see shelter NFIs*

### non-humanitarian stakeholder

31

---

## O

### occupancy

with no legal status 5, 21

### one room shelter

*see CORE housing*

### outreach programme

40, 72

### owner

131

land *see land owner*

### ownership

113, 129, 130, 133

---

## P

### packages

NFI 120

transit 94

### pad foundations

184

### Pakistan

18, 112, 116, 121, 122

### paint

156

### participation

46, 58, 127

community 110



**participatory approach to safe shelter awareness (PASSA)** 111, 124  
**partner organisation** 49  
**Peru** 12, 168  
**pest**  
 control 121, 156  
**pesticide** 121  
**phase** 124, 144  
**plan**  
 building *see building plan*  
 contingency *see contingency plan*  
 emergency *see emergency plan*  
 mitigation *see mitigation plan*  
 programme *see programme plan*  
 project *see project plan*  
 sectoral monitoring *see sectoral monitoring plan*  
**planned**  
 camp 4, 21, 24  
**planning** 44–46, 104–106, 113, 114, 133  
 codes 73, 124  
 contour *see contour planning*  
 indicators 98–102  
 processes 125  
 settlement *see settlement plan*  
 site *see site plan*  
 tools 51  
**plastic sheeting** 84–85  
**plinth** 148  
**population** 120, 122, 127  
 affected 35, 140, 141, 146, 147, 150, 180  
 displaced 122, 128, 130  
**post-disaster**  
 response 32  
 supply capacities 83  
**prefabricated parts** 8, 27, 80–81  
**preliminary assessment** 57  
**privacy** 25, 127, 142  
**procurement**  
 competitive *see competitive procurement*  
 local 78–79  
 international 79–80  
 policies 80–81, 85  
 process 63, 77–80  
 rapid *see rapid procurement*  
**programme**  
 assessment 56–58  
 design 44–45, 48, 113  
 manager 47–49  
 objectives 46–47  
 outreach *see outreach programme*  
 plan 44–46  
 settlement *see settlement programme*  
 shelter *see shelter programme*  
 staff 48–49, 97  
 strategy 11, 135  
 WASH *see WASH programme*  
**property** 136  
 restitutions 94  
 rights 93–94, 139  
**protection** 31, 34, 88, 112, 113, 123, 130, 139, 140

## Q

**quality assurance**  
 control 96–97

## R

**rainfall** 119, 120, 150  
**rapid**  
 assessment 57  
 procurement 84–85  
**reception centre** 128  
**reconstruction** 110, 128, 147, 169, 181  
 3-phase 3  
 6 options 5  
 parallel 13, 111  
 programme 23  
 strategy 116, 125, 126, 131, 133  
 sustainable 130  
 transitional *see transitional reconstruction*  
**recovery** 130, 132  
 early 33–34  
 objectives 46  
**relief item** 3  
**religious**  
 background 122  
 buildings 94  
**resource management** 48, 95, 143  
**resources** 125, 126, 143  
 financial *see financial resources*  
 human *see human resources*  
 local *see local resources*  
 natural *see natural resources*  
**response** 114, 124, 130, 135  
 cycle 3  
 post-disaster 1–3, 129  
 shelter 1–3  
 strategy 4  
**rights**  
 land *see land rights*  
 legal *see legal rights*  
**risk**  
 assessment 59–60, 123–124, 147–167  
 reduction 60, 147–167  
**rodent-proof** 156  
**roof** 191–193  
 construction 192–193  
 details 191–193  
 orientation 192–193  
 shape 192  
**rural self-settlement** 4, 21

## S

**safe building** 99  
**safety** 26, 114–118, 123, 128, 143  
**sanitation** 116, 121, 127, 128  
**school** 110, 111, 120, 123, 126, 127  
**sector** 128  
 coordination body 31–35, 171  
 humanitarian *see humanitarian sector*  
 private *see private sector*

1

definition

definition of TS  
 10 TS principles  
 5 characteristics  
 when not to use TS  
 SWOT

2

tool

decision-making tool

3

programme

coordination  
 programme plan  
 assessment  
 beneficiaries  
 labour  
 materials  
 procurement  
 support  
 quality assurance

4

site

community  
 site selection  
 site planning  
 land tenure  
 handover

5

design

socio-cultural  
 minimise risk  
 climatic design  
 materials  
 construction

resources

shelter *see shelter sector*  
 specialist 114, 127  
 stakeholders 35, 40  
 strategy 44  
**sectoral monitoring plan** 44, 45  
**security** 112, 127, 130, 132, 134  
   measures 88–91, 100, 143  
**self-help** 27, 112  
   labour 74  
**self-settled camp** 4, 125  
**self-settlement**  
   rural *see rural self-settlement*  
   urban *see urban self-settlement*  
**semi-permanent shelter** 17, 24  
**settlement** 115, 119, 124, 126, 131  
   options 4, 13, 32, 45, 59, 65  
   planning 33, 94, 125  
   programmes 127  
   transitional *see transitional settlement*  
**sewage** 121, 148  
**shading** 151, 164, 165  
**shelter** 118, 129–133, 135–136  
   approach 113, 124, 130–131, 135, 141, 146, 150  
   assistance 130  
   construction items 168–179  
   design 21, 181, 189, 193–194  
   emergency *see emergency shelter*  
   kits 130  
   materials 143  
   NFIs 170  
   process 6, 13  
   project 110, 180  
   programme 132, 157–159, 168, 180  
   semi-permanent *see semi-permanent shelter*  
   strategy 115, 116, 125  
   transitional *see transitional shelter*  
**site** 123–125  
   appropriateness 114  
   planning 13, 23, 110, 113, 123, 126, 128, 136, 157  
   selection 110, 114, 115, 117, 120, 136  
**sites and services** 18  
**slab foundations** 182–183, 186–188  
**smoke**  
   hoods 156  
**social**  
   capital 61, 62  
   cohesion 71–71  
   context 59  
   factors 83–100  
   insecurity 91  
   stigma 91  
   structure 54, 140  
   values 66  
**soil** 118, 119, 151, 173, 174, 178, 189  
**solar**  
   gain 161, 164, 166  
   water heater 156  
**Somalia** 157  
**sourcing** 76–80, 173  
**specialists** 21, 49, 73, 92, 120, 121, 126, 127, 130, 132, 139–140, 159  
**squatter** 131  
**Sri Lanka** 7, 12, 14, 140–181  
**stakeholder** 114, 127, 129, 133, 135  
   humanitarian *see humanitarian stakeholder*  
   non-humanitarian *see non-humanitarian stakeholder*  
   roles and responsibilities 35–36, 55  
   sector *see sector stakeholder*  
**standards** 23, 25  
   building *see building codes and standards*  
   international *see international codes and standards*  
   national *see national codes and standards*  
   technical 73  
**status** 139–140  
**steel** 169, 172, 175, 177, 183–190, 192–193  
**stockpile** 85, 88  
**storage** 49, 78, 125, 149, 173  
**storm** 119  
   resilience 152–154  
   prone 119  
**stoves** 156–157, 160, 166–167  
**strategic advisory group (SAG)** 36–38  
**strategy** 23  
   communication *see communication strategy*  
   coordination *see coordination strategy*  
   exit *see exit strategy*  
   programme *see programme strategy*  
   response *see response strategy*  
   sector *see sector strategy*  
   shelter *see shelter strategy*  
   ventilation *see ventilation strategy*  
**strengths, weaknesses, opportunities and threats (SWOT)** 17, 18–20, 48  
**strip foundations** 182, 185  
**structure** 128  
   coordination *see coordination structure*  
   family *see family structure*  
   government *see government structure*  
   social 140  
**sub-national coordination hub** 37  
**supply chain** 86–89  
**support** 123, 127, 128  
   livelihood *see livelihood support*  
   market *see market support*  
   methods 22, 90–95, 187  
   planning *see planning support*  
**survey**  
   land use 40  
**suspended floor** 184, 187

---

## T

**team**  
   field *see field team*  
   multi-disciplinary 37–39, 49  
   rescue 57  
**technical**  
   assistance 35, 41  
   capacity 25, 70, 92, 97

working group (TWiG) 36–39, 171

**temperature** 26, 159, 160

**tender** 73, 85, 97

**tenure** 131, 132, 134

- arrangements 133
- assistance 64, 93
- land *see land tenure*
- security 129, 132, 133
- systems 129–132
- type 129

**thatch** 179

**thermal comfort** 159

**toxic threat** 121

**traditions** 48, 127, 138

**training** 47, 50

**transit**

- items 28, 69, 94
- packages 94

**transitional shelter** 21, 22, 28, 110, 123, 125, 132, 136

- approach 2, 17, 129–131, 135
- characteristics *see characteristics of transitional shelter*
- decision-making tool 17
- definition 2
- principles 10–14, 17, 110, 112, 114–117, 120, 123, 125, 130–132, 136
- process 2–3,
- programme 110, 114, 115, 120, 125–126, 128, 132–136
- project 125
- settlement 127
- SWOT analysis 17, 18–20

**transport**

- capacities 84

**tsunami** 117

- resilience 154
- prone 120

## U

**Uganda** 170

**unexploded ordnance (UXO)** 122

**urban self-settlement** 4, 21, 65

## V

**vector** 117, 120, 121

- entry 165
- control 26, 120, 155

**vegetation** 118–120

**ventilation** 26, 128, 152, 154, 155, 160–161, 164

- natural *see natural ventilation*
- principles 163, 165
- strategy 165

**volcano**

- resilience 155
- prone 120

**vouchers** 28, 69, 91

**vulnerable group** 11, 67, 88, 93–94, 113, 120, 127, 141, 142, 169

## W

**warm-humid climate** 161–164

**water, sanitation and hygiene (WASH)**

- issues 116, 135
- programme 111, 126

**wind** 119

- uplift 181

**window** 152, 154, 155, 158, 163, 170, 191

## 1

definition of TS

10 TS principles

5 characteristics

when not to use TS

SWOT

## definition

## 2

decision-making tool

## tool

## 3

coordination

programme plan

- assessment
- beneficiaries
- labour
- materials
- procurement
- support

quality assurance

## programme

## 4

community

site selection

site planning

land tenure

handover

## site

## 5

socio-cultural

minimise risk

climatic design

- materials
- construction

## design

## resources

# 5 TRANSITIONAL SHELTER CHARACTERISTICS



## UPGRADABLE

While being inhabited, transitional shelter may be upgraded over time. Components may be replaced or improved to achieve a more durable solution.



## REUSABLE

Transitional shelter may be reused for different purposes once a durable solution is achieved. This may include reuse as a barn, workshop or an external kitchen.



## RELOCATABLE

Relocation distinguishes transitional shelter from other shelter approaches. A transitional shelter may be relocated to cope with insecure land tenure situations.



## RESALEABLE

Components of a transitional shelter may be dismantled and resold. These resources can contribute to permanent reconstruction.



## RECYCLABLE

Transitional shelter is inhabited while parallel reconstruction activities are taking place. The transitional shelter may be partly dismantled to contribute to the permanent house.

Transitional shelter, Lompré/Haiti  Cordaid Haiti





# TRANSITIONAL SHELTER RESOURCES

Scan this code with your smartphone to be directed to the Shelter Centre library with access to download:

- ▶ the transitional shelter guidelines
- ▶ other transitional shelter guidance and fact sheets
- ▶ case studies
- ▶ other related guidance including coordination and standards



# TRANSITIONAL SHELTER GUIDELINES

## 10 TRANSITIONAL SHELTER PRINCIPLES



### ASSESS SITUATION

The appropriateness of a transitional shelter response should be comprehensively assessed for each situation and beneficiary group



### INVOLVE COMMUNITY

The affected population should be partners in developing a transitional shelter strategy and leaders of local implementation



### DEVELOP STRATEGY

Transitional shelter should be used as part of a comprehensive, inter-sectoral strategy, developed in consultation with all stakeholders, including the government and affected population



### REDUCE VULNERABILITY

Transitional shelter programmes should reduce the vulnerability of the affected population



### AGREE STANDARDS

Appropriate standards should be developed and agreed in consultation with each beneficiary group



### MAXIMISE CHOICE

Shelters implemented as part of transitional shelter programmes should maximise the choice of shelter options for the affected population throughout the transition to a durable shelter solution



### BUY TIME

Transitional shelter programmes should allow sufficient time for sustainable reconstruction



### INCREMENTAL PROCESS

Transitional shelter is an incremental process which starts with the distribution of relief items and continues until durable solutions have been achieved



### SITE PLAN

Site planning should be used to support communities as part of transitional shelter programmes



### RECONSTRUCTION

Shelters implemented as part of a transitional shelter approach should complement and contribute to reconstruction programmes

